

HONDA

ES

| | | | | | |
|---|-----|-------------------------------------|-----|---|-----|
| GUÍA MANTENIMIENTO COLAS Y Y KITS | 545 | DESCONECTORES DE SEGURIDAD | 561 | JUNTAS BASE DE MOTOR | 574 |
| SISTEMA DE ALIMENTACIÓN Y FILTRACIÓN | 547 | LLAVES DE ARRANQUE | 564 | JUNTAS BOMBA DE ACEITE | 574 |
| ACEITE | 553 | MOTORES DE ARRANQUE | 560 | JUNTAS CULATA | 574 |
| BOMBA DE COMBUSTIBLE EN LÍNEA | 547 | SENSORES | 557 | JUNTAS SILENCIOSO | 574 |
| ABRAZADERA PARA MANGUERA | 548 | SENSOR DETONACIÓN | 558 | JUNTAS TAPÓN DRENAJE | 575 |
| ADAPTADOR LÍNEA DE COMBUSTIBLE | 548 | SENSOR MAP | 557 | KIT JUNTAS DE CULATA | 575 |
| BOMBA DE COMBUSTIBLE | 547 | SENSOR MAT, TEMPERATURA DEL AIRE | 558 | SISTEMA DE ESCAPE Y ADMISIÓN 576 | |
| LÍNEA DE COMBUSTIBLE | 547 | SENSOR POSICIÓN CIGÜEÑAL | 557 | SISTEMA DE ADMISIÓN | 576 |
| MANGUERA DE COMBUSTIBLE | 547 | SENSOR POSICIÓN LEVAS | 557 | JUNTAS | 576 |
| MUELLE TUBO COMBUSTIBLE | 548 | SENSOR PRESIÓN DE ACEITE | 558 | RETÉN DE VÁLVULA | 576 |
| BOMBA DE COMBUSTIBLE ELÉCTRICA | 555 | SENSOR OXÍGENO | 558 | SISTEMA DE ESCAPE | 576 |
| CARBURADOR | 555 | TRIM, TILT & POWER TRIM | 562 | RETÉN DE VÁLVULA | 576 |
| AGUJA DE CARBURADOR | 555 | EXTRACTOR TAPONES DE TRIM | 563 | UNIDADES DE TRANSMISIÓN 577 | |
| GUÍA CARBURADORES | 556 | INSTALACIÓN ELÉCTRICA | 562 | DESPIECE COLAS | 577 |
| KITS CARBURADORES | 556 | POWER TRIM COMPLETO | 563 | BF75AT • BF90AT | 577 |
| COMPONENTES TANQUE Y CONECTORES | 548 | TRIM COMPLETO | 562 | COMPONENTES DE COLA | 578 |
| CONECTOR DE DEPÓSITO | 548 | SISTEMA DE GOBIERNO 564 | | ARANDELA DE CIERRE | 579 |
| PASAMAMPAROS | 549 | CABLES DE CONTROL | 565 | EJE HÉLICE | 579 |
| FILTRO DE ACEITE | 554 | LLAVES DE ARANQUE | 565 | JUNTA EJE SELECTOR | 578 |
| GUÍA FILTROS DE ACEITE | 554 | MANDOS DE CONTROL | 564 | KITS JUNTAS Y RETENES | 578 |
| FILTRO DE COMBUSTIBLE Y ELEMENTOS | 549 | SISTEMA DE REFRIGERACIÓN 566 | | RETENES EJE DE CAMBIO | 578 |
| BRACKET | 549 | ÁNODOS | 571 | RETENES EJE DE HELICE | 578 |
| FILTRO COMBUSTIBLE MONTAJE EN LÍNEA | 552 | ÁNODO CANADA METAL | 571 | RETENES EJE DE TRANSMISIÓN | 578 |
| FILTRO COMBUSTIBLE SEPARADOR AGUA | 549 | ÁNODO TECNOSEAL | 573 | RODAMIENTO DIÁBOLO | 579 |
| FILTRO DECANTADOR DE COMBUSTIBLE COMPLETO CON VASO TRANSPARENTE | 550 | BOMBA DE AGUA | 569 | RODAMIENTO PIÑÓN AVANTE | 579 |
| FILTRO DECANTADOR DE GASOLINA | 550 | JUNTAS BOMBA | 569 | TUERCA DE DIÁBOLO | 579 |
| LLAVES PARA FILTRO | 552 | KITS DE REPARACIÓN BOMBA DE AGUA | 570 | SISTEMA DE PROPULSIÓN 580 | |
| RACOR DE LATÓN | 552 | RETÉN CUERPO DE BOMBA | 570 | HÉLICES ALUMINIO E INOXIDABLE DE 3 Y 4 PALAS | 580 |
| INYECTORES | 555 | IMPULSORES | 567 | GUÍA HÉLICES CON NÚCLEO INTEGRADO | 581 |
| SISTEMA ELÉCTRICO 557 | | CHAVETA | 569 | HÉLICES PARA NÚCLEO INTERCAMBIABLE | 582 |
| ALTERNADORES | 561 | GUÍA IMPULSORES | 568 | NÚCLEO INTERCAMBIABLE | 582 |
| CORREAS DE ALTERNADOR | 562 | TERMOSTATO | 566 | REF --> RO | 583 |
| BOBINAS | 559 | PARTES DEL MOTOR | 574 | RO --> REF | 585 |
| BUJÍAS | 559 | GUÍA CORREAS DE DISTRIBUCIÓN | 575 | | |
| | | JUNTAS DE MOTOR | 574 | | |

EN

| | | | | | |
|--|-----|------------------------------------|-----|--|-----|
| DRIVES MAINTENANCE GUIDE & KITS | 545 | SENSORS | 557 | ENGINE PARTS | 574 |
| FUEL & FILTRATION SYSTEM | 547 | SENSOR, CAMSHAFT | 557 | ENGINE GASKETS | 574 |
| CARBURETOR | 555 | SENSOR, CRANKSHAFT | 557 | GASKET, CYLINDER | 574 |
| CARBURETOR KITS | 556 | SENSOR, KNOCK | 558 | GASKET, CYLINDER HEAD | 574 |
| CARBURETOR NEEDLE VALVE | 555 | SENSOR, MAP | 557 | GASKET KIT | 575 |
| GUIDE CARBURETORS | 556 | SENSOR MAT, AIR TEMPERATURE | 558 | GASKET, MUFFLER | 574 |
| ELECTRIC FUEL PUMP | 555 | SENSOR, O2 | 558 | GASKET, OIL PUMP | 574 |
| FUEL FILTERS AND ELEMENTS | 549 | SENSOR, PRESSURE OIL | 558 | O-RING, DRAIN CAP | 575 |
| BRACKET | 549 | SPARK | 559 | TIMING BELT | 574 |
| COMPLETE FUEL FILTER | 550 | STARTERS | 560 | EXHAUST & INTAKE SYSTEM 576 | |
| COMPLETE FUEL FILTER WITH TRANSPARENT BOWL | 550 | TRIM, TILT & POWER TRIM | 562 | EXHAUST SYSTEM | 576 |
| FILTER KEY | 552 | COMPLETE POWER TRIM ASSEMBLY | 563 | VALVE SEALS | 576 |
| IN-LINE FUEL FILTER | 552 | COMPLETE TRIM ASSEMBLY | 562 | INTAKE SYSTEM | 576 |
| RACORS | 552 | TRIM PLUGS EXTRACTOR | 563 | GASKETS & VALVE SEALS | 576 |
| WATER SEPARATING FUEL FILTER | 549 | WIRING HARNESS | 561 | UNIT DRIVES & COMPONENTS 577 | |
| FUEL PUMP IN LINE | 547 | STEERING SYSTEM 564 | | DRIVE COMPONENTS | 577 |
| CLAMP SMALL | 548 | ENGINE CONTROLS | 564 | CARRIER BEARING | 579 |
| COUPLER | 548 | CONSOLE CONTROL | 564 | FORWARD GEAR BEARING | 579 |
| FUEL HOSE | 547 | CONTROL CABLES | 565 | NUT, GEARCASE END | 579 |
| FUEL LINE ASSEMBLY | 547 | SIDE CONTROL | 564 | O-RING DRIVE SHAFT | 578 |
| SPRING, FUEL PIPE | 548 | IGNITION STARTER SWITCH | 565 | PROPELLER SHAFT | 579 |
| FUEL TANK COMPONENTS & CONNECTORS | 548 | COOLING SYSTEM | 566 | SEAL DRIVE SHAFT | 578 |
| TANK CONNECTOR | 548 | ANODES | 571 | SEAL KITS | 578 |
| THRU HULL | 549 | ANODES CANADA METAL | 571 | SEAL PROPELLER SHAFT | 578 |
| INJEKTOR | 555 | ANODES TECNOSEAL | 573 | TAB WASHER | 579 |
| OIL | 553 | IMPELLERS | 567 | PROPULSION SYSTEM 580 | |
| OIL FILTER | 554 | IMPELLERS GUIDE | 568 | 3 & 4 BLADE ALUMINIUM & SS PROPELLERS | 580 |
| OIL FILTER GUIDE | 554 | KEY | 569 | INTERCHANGEABLE HUB | 582 |
| ELECTRIC SYSTEM 557 | | THERMOSTAT | 566 | PROPELLERS APPLICATION WITH RUBBER HUB | 581 |
| ALTERNATOR | 561 | WATER PUMP | 569 | PROPELLERS FOR INTERCHANGEABLE HUB | 582 |
| ALTERNATOR BELT | 562 | SEAL WATER PUMP | 570 | REF --> OEM | 583 |
| COILS | 559 | SERVICE KIT | 570 | OEM --> REF | 585 |
| CUT OFF SWITCHES | 561 | WATER PUMP GASKET | 569 | | |

| | | | | | |
|---|-----|----------------------------------|-----|---|-----|
| GUIDA MANUTENZIONE E KIT | 545 | MOTORINI AVVIAMENTO | 560 | GUARNIZIONE TAPPO DRENAGIO | 575 |
| SISTEMA DI ALIMENTAZIONE E FILTRAZIONE | 547 | SENSORE | 557 | GUARNIZIONE OLIO | 574 |
| CARBURATORE | 555 | SENSORE ALBERO A CAME | 557 | GUARNIZIONE SILENZIATORE | 574 |
| KIT CARBURATORI | 556 | SENSORE ALBERO MOTORE | 557 | GUARNIZIONE TESTATA | 574 |
| SPILLO CONICO CARBURATORE | 555 | SENSORE ANTIDETONAZIONE | 558 | KIT GUARNIZIONE TESTATA | 575 |
| COMPONENTI SERBATOIO E CONETTORI | 548 | SENSORE MAP | 557 | GUIDA CINGHIE DISTRIBUZIONE | 575 |
| ATTACCO SERBATOIO | 548 | SENSORE MAT. TEMPERATURA ARIA | 558 | SISTEMA DI SCARICO E ASPIRAZIONE | 576 |
| PASSASCAFO | 549 | SENSORE OSSIGENO | 558 | SISTEMA ASPIRAZIONE | 576 |
| FILTRI BENZINA E RACCORDI | 549 | SENSORE PRESSIONE DELL'OLIO | 558 | GUARNIZIONE | 576 |
| CHIAVE DA FILTRO | 552 | TRIM, TILT & POWER TRIM | 562 | TENUTE | 576 |
| FILTRO BENZINA ALTA PRESSIONE | 552 | ESTRATTORE PER TAPPI DI TRIM | 563 | SISTEMA SCARICO | 576 |
| FILTRO BENZINA PER MONTARE IN LINEA | 552 | INSTALLAZIONE ELETTRICA | 562 | TENUTE | 576 |
| FILTRO DECATATORE BENZINA | 550 | MOTORINO POWER TRIM COMPLETO | 563 | | |
| FILTRO DI DECATAZIONE BENZINA COMPLETO CON VASCETTA TRASPARENTE | 550 | MOTORINO TRIM COMPLETO | 562 | UNITÀ DI TRASMISSIONE | 577 |
| FILTRO SEPARATORE ACQUA-BENZINA | 549 | SISTEMA DI GUIDA | 564 | COMPONENTI PIEDI | 578 |
| RACCORDI | 552 | CAVI COMANDI | 565 | ASSE ELICA | 579 |
| SUPPORTO | 549 | COMANDI DI CONTROLLO | 564 | CUSCINETTO DIAVOLO | 579 |
| FILTRO OLIO | 554 | CHIAVI DI ACCENSIONE | 565 | CUSCINETTO PIGNONE AVANTI | 579 |
| GUIDA FILTRO OLIO | 554 | SISTEMA DI RAFFREDDAMENTO | 566 | DADO DIAVOLO | 579 |
| INIETTORE | 555 | ANODI | 571 | KIT GUARNIZIONE E TENUTE | 578 |
| OLIO | 553 | ANODI CANADA METAL | 571 | TENUTE ASSE DI CAMBIO | 578 |
| POMPA BENZINA ELETTRICA | 555 | ANODI TECNOSEAL | 573 | TENUTE ASSE DI ELICA | 578 |
| POMPA BENZINA IN LINEA | 547 | GIRANTE | 567 | TENUTE ASSE DI TRASMISSIONE | 578 |
| ADATTATORE | 548 | CIAVETTA | 569 | RONDELLA CHIUSURA | 579 |
| FASCETTE | 548 | GUIDA GIRANTE | 568 | PARTI PIEDI | 577 |
| MOLLA TUBO COMBUSTIBILE | 548 | POMPA ACQUA | 569 | BF75AT • BF90AT | 577 |
| TUBO BENZINA | 547 | GUARNIZIONE POMPA | 569 | SISTEMA DI PROPULSIONE | 580 |
| TUBO CARBURANTE | 547 | KIT RICAMBI POMPA ACQUA | 570 | HELICHE ALLUMINIO E INOX DA 2 E 4 PALE | 580 |
| SISTEMA ELETTRICO | 557 | TENUTE CORPO POMPA | 570 | ELICHE PER MOZZO INTERCAMBIABILE | 582 |
| ALTERNATORE | 561 | TERMOSTATO | 566 | GUIDA ELICHE CON MOZZO | 581 |
| CURROIA ALTERNATORE | 562 | PARTI MOTORE | 574 | MOZZO INTERCAMBIABILE | 582 |
| BOBINE | 559 | GUARNIZIONI MOTORE | 574 | REF --> RO | 583 |
| CANDELE | 559 | GUARNIZIONE BASE MOTORE | 574 | RO --> REF | 585 |
| CHIAVETTA DI SICUREZZA | 561 | | | | |
| INTERRUTTORE DI STOP | 561 | | | | |
| KIT | 561 | | | | |

| | | | | | |
|--|-----|-------------------------------------|-----|---|-----|
| GUIDE KITS DE MAINTENANCE | 545 | CAPTEUR DE CLIQUETIS | 558 | JOINTS DE POMPE À HUILE | 574 |
| SYSTÈME D'ALIMENTATION ET DE FILTRATION | 547 | CAPTEUR DE POSITION D'ARBRE À CAMES | 557 | JOINTS DE SILENCIEUX | 574 |
| CARBURATEUR | 555 | CAPTEUR DE POSITION DU VILEBREQUIN | 557 | JOINTS DE VIDANGE | 575 |
| GUIDE DES CARBURATEURS | 556 | CAPTEUR MAP | 557 | KIT JOINTS DE MOTEUR | 575 |
| KIT CARBURATEUR | 556 | CAPTEUR MAT DE TEMPERATURE D'AIR | 558 | SYSTÈME D'ÉCHAPPEMENT ET SYSTÈME D'ADMISSION | 576 |
| POINTEAU CARBURATEUR | 555 | CAPTEUR PRESSION D'HUILE | 558 | SYSTÈME D'ADMISSION | 576 |
| COMPONENTS ET CONNECTEURS DU RÉSERVOIR | 548 | COUPE CIRCUIT DE SECURITE | 561 | JOINTS DE SOUPAPE | 576 |
| PASSE-CLOISON | 549 | KITS | 561 | SYSTÈME D'ÉCHAPPEMENT | 576 |
| RACCORDS DE RESERVOIR | 548 | DEMARREUR | 560 | JOINTS DE SOUPAPE | 576 |
| FILTRE À ESSENCE ET CARTOUCHE DE RECHANGE | 549 | TRIM, TILT & POWER TRIM | 562 | EMBASSES ET PIÈCES | 577 |
| CLÉ À FILTRE | 552 | INSTALLATION ELECTRIQUE | 562 | EMBASSES | 577 |
| FILTRE À ESSENCE EN LIGNE | 552 | KIT EXTRACTEUR | 563 | BF75AT • BF90AT | 577 |
| FILTRE DÉCANTEUR ESSENCE | 550 | MOTEUR DE TRIM | 562 | PIÈCES | 578 |
| FILTRE DÉCANTEUR ESSENCE AVEC BOL TRANSPARENT | 550 | POWER TRIM COMPLET | 563 | ARBRE D'HELICE | 579 |
| FILTRE SÉPARATEUR EAU-ESSENCE | 549 | SYSTÈME DE COMMANDE | 564 | ÉCROU DE DIABOLO | 579 |
| RACCORDS | 552 | BOITIER DE COMMANDE | 564 | JOINTS D'ARBRE DE SELECTEUR | 578 |
| TÊTE DE FILTRE À ESSENCE | 549 | CÂBLES DE COMMANDE | 565 | JOINTS SPI ARBRE DE CHANGEMENT | 578 |
| FILTRE À HUILE | 554 | CONTACTEUR À CLÉ | 565 | JOINTS SPI ARBRE DE TRASMISSION | 578 |
| GUIDE DES FILTRES À HUILE | 554 | SYSTÈME DE REFROIDISSEMENT | 566 | KITS JOINTS D'EMBASSES | 578 |
| HUILES | 553 | ANODES | 571 | RONDELE FREIN | 579 |
| INJECTEURS | 555 | ANODE CANADA METAL | 571 | ROULEMENT DE DIABOLO | 579 |
| POIRE À CARBURANT | 547 | ANODE TECNOSEAL | 573 | ROULEMENT DE PIGNON AVANT | 579 |
| COLLIER | 548 | TURBINES | 567 | SYSTEME DE PROPULSION | 580 |
| RACCORD COUPLEUR | 548 | CLAVETTE | 569 | HELICE ALUMINIUM ET INOX 3 ET 4 PALES | 580 |
| RESSORT, TUYAU DE CARBURANT | 548 | GUIDE DE TURBINES | 568 | GUIDE DES HÉLICES ET MOYEUX | 581 |
| TUYAU CARBURANT | 547 | POMPE D'EAU | 569 | HELICES AVEC MOYEU INTERCHANGEABLE | 582 |
| POMPE À ESSENCE ÉLECTRIQUE | 555 | JOINTS SPI DE POMPE À EAU | 570 | MOYEU INTERCHANGEABLE | 582 |
| SYSTÈME ÉLECTRIQUE | 557 | JOINTS POMPE | 569 | REF --> RO | 583 |
| ALTERNATEUR | 561 | KIT REPARATION DE POMPE À EAU | 570 | RO --> REF | 585 |
| COURROIE D'ALTERNATEUR | 562 | TERMOSTAT | 566 | | |
| BOBINES | 559 | PIÈCES MOTEUR | 574 | | |
| BOUGIES | 559 | COURROIES DE DISTRIBUTION | 575 | | |
| CAPTEURS | 557 | JOINTS DE MOTEUR | 574 | | |
| CAPTEUR À OXYGENE | 558 | JOINTS DE CULASSE | 574 | | |
| | | JOINTS DE TÊTE MOTRICE | 574 | | |



GUÍA KITS MANTENIMIENTO

MAINTENANCE GUIDE & KITS

GUIDA MANUTENZIONE E KIT

GUIDE KITS MAINTENANCE

| | KIT | REF | | | | | | |
|----------------------------------|-----|--------------------|------------------|---------------------|-------------------|-----------------------|---------------------------|---|
| BF4 BF4.5 BF5 | | REC06211-ZV1-505 | REC06192-ZV1-C00 | KIT TURBINA | IMPELLER KIT | KIT GIRANTE | KIT TURBINE | 1 |
| | | NGKBPR5ES | | BUJÍA | SPARK PLUG | CANDELE | BOUGIE | 1 |
| | | REC19300-881-761 | | TERMOSTATO | THERMOSTAT | TERMOSTATO | TERMOSTAT | 1 |
| | | REC16910-GB2-005 | | FILTRO COMBUSTIBLE | FUEL FILTER | FILTRO COMBUSTIBILE | FILTRE À ESSENCE | 1 |
| | | TEN01402 | | ÁNODO | ANODE | ANODO | ANODE | 1 |
| | | PAGB/T91-2.5X30 | | PIN | PIN | PIN | GOUPILLE | 1 |
| BF8 BF9.9D BF10 | | REC06211-ZW9-505 | REC19210-ZW9-013 | TURBINA | IMPELLER | GIRANTE | TURBINE | 1 |
| | | NGKCR5EH-9 | | BUJÍA | SPARK PLUG | CANDELE | BOUGIE | 2 |
| | | PAF15-07000031 | | TERMOSTATO | THERMOSTAT | TERMOSTATO | TERMOSTAT | 1 |
| | | REC16910-ZV4-015 | | FILTRO COMBUSTIBLE | FUEL FILTER | FILTRO COMBUSTIBILE | FILTRE À ESSENCE | 1 |
| | | REC35-822626Q03 | | FILTRO DE ACEITE | OIL FILTER | FILTRO OLIO | FILTRE A HUILE | 1 |
| | | CM41106-ZW9-09000 | | ÁNODO | ANODE | ANODO | ANODE | 2 |
| BF9.9A BF15A | | REC06211-ZV4-505 | REC06192-ZV4-000 | KIT TURBINA | IMPELLER KIT | KIT GIRANTE | KIT TURBINE | 1 |
| | | REC19300-881-761 | | TERMOSTATO | THERMOSTAT | TERMOSTATO | TERMOSTAT | 1 |
| | | NGKDR6HS | | BUJÍA | SPARK PLUG | CANDELE | BOUGIE | 2 |
| | | REC16910-ZV4-015 | | FILTRO COMBUSTIBLE | FUEL FILTER | FILTRO COMBUSTIBILE | FILTRE À ESSENCE | 1 |
| | | TEN01402 | | ÁNODO | ANODE | ANODO | ANODE | 1 |
| | | PAGB/T91-2.5X30 | | PIN | PIN | PIN | GOUPILLE | 1 |
| BF15D BF20D | | REC06211-ZY0-505 | REC06192-ZW9-A30 | KIT TURBINA | IMPELLER KIT | KIT GIRANTE | KIT TURBINE | 1 |
| | | PAGB/T91-2.5X30 | | PIN | PIN | PIN | GOUPILLE | 1 |
| | | PAF15-07000031 | | TERMOSTATO | THERMOSTAT | TERMOSTATO | TERMOSTAT | 1 |
| | | REC35-822626Q03 | | FILTRO DE ACEITE | OIL FILTER | FILTRO OLIO | FILTRE A HUILE | 1 |
| | | NGKCR5EH-9 | | BUJÍA | SPARK PLUG | CANDELE | BOUGIE | 2 |
| | | CM41106-ZW9-09000 | | ÁNODO | ANODE | ANODO | ANODE | 2 |
| BF25D BF30D | | REC16910-ZV4-015 | REC16910-ZV4-015 | FILTRO COMBUSTIBLE | FUEL FILTER | FILTRO COMBUSTIBILE | FILTRE À ESSENCE | 1 |
| | | REC35-822626Q03 | | FILTRO DE ACEITE | OIL FILTER | FILTRO OLIO | FILTRE A HUILE | 1 |
| | | PAGB/T91-2.5X30 | | PIN | PIN | PIN | GOUPILLE | 1 |
| | | PAF15-07000031 | | TERMOSTATO | THERMOSTAT | TERMOSTATO | TERMOSTAT | 1 |
| | | REC06192-ZV7-000 | | KIT TURBINA | IMPELLER KIT | KIT GIRANTE | KIT TURBINE | 1 |
| | | TEN01408/1 | | ÁNODO | ANODE | ANODO | ANODE | 1 |
| | | CM41107-ZV500A | | ÁNODO | ANODE | ANODO | ANODE | 1 |
| | | REC12-191833 | | JUNTA DRENAJE COLA | DRAIN PLUG GASKET | GUARNIZIONE DRENAGGIO | JOINT DE VIDANGE D'EMBASE | 2 |
| | | PAF15-04000003 | | JUNTA DRENAJE COLA | DRAIN PLUG GASKET | GUARNIZIONE DRENAGGIO | JOINT DE VIDANGE D'EMBASE | 1 |
| NGKDR7EA | | BUJÍA | SPARK PLUG | CANDELE | BOUGIE | 3 | | |
| BF35A BF40A BF45A BF50A | | REC06211-ZV5-505 | REC06192-ZV5-003 | KIT TURBINA | IMPELLER KIT | KIT GIRANTE | KIT TURBINE | 1 |
| | | PAGB/T91-2.5X30 | | PIN | PIN | PIN | GOUPILLE | 1 |
| | | NGKDR7EA | | BUJÍA | SPARK PLUG | CANDELE | BOUGIE | 3 |
| | | REC35-822626Q03 | | FILTRO DE ACEITE | OIL FILTER | FILTRO OLIO | FILTRE A HUILE | 1 |
| | | PAF15-07000031 | | TERMOSTATO | THERMOSTAT | TERMOSTATO | TERMOSTAT | 1 |
| | | CMHBF4050KITA | | KIT ANODO | ANODE KIT | KIT ANODO | KIT ANODE | 1 |
| | | REC12-191833 | | JUNTA DRENAJE COLA | DRAIN PLUG GASKET | GUARNIZIONE DRENAGGIO | JOINT DE VIDANGE D'EMBASE | 2 |
| | | PAF15-04000003 | | JUNTA DRENAJE COLA | DRAIN PLUG GASKET | GUARNIZIONE DRENAGGIO | JOINT DE VIDANGE D'EMBASE | 1 |
| REC16900-SA5-004 | | FILTRO COMBUSTIBLE | FUEL FILTER | FILTRO COMBUSTIBILE | FILTRE À ESSENCE | 1 | | |

| | KIT | REF | | | | | | | | |
|-----------------------------|-----|------------------|------------------|--------------------|-------------------|-----------------------|---------------------------|-------------|----------------|---|
| BF40D BF50D | | REC06211-ZZ5-505 | REC06192-ZV5-003 | KIT TURBINA | IMPELLER KIT | KIT GIRANTE | KIT TURBINE | 1 | | |
| | | PAGB/T91-2.5X30 | | PIN | PIN | PIN | GOUPILLE | 1 | | |
| | | NGKDR7EB | | BUJÍA | SPARK PLUG | CANDELE | BOUGIE | 3 | | |
| | | REC35-822626Q03 | | FILTRO DE ACEITE | OIL FILTER | FILTRO OLIO | FILTRE A HUILE | 1 | | |
| | | PAF15-07000031 | | TERMOSTATO | THERMOSTAT | TERMOSTATO | TERMOSTAT | 1 | | |
| | | CMHBF4050KITA | | KIT ANODO | ANODE KIT | KIT ANODO | KIT ANODE | 1 | | |
| | | REC12-191833 | | JUNTA DRENAJE COLA | DRAIN PLUG GASKET | GUARNIZIONE DRENAGGIO | JOINT DE VIDANGE D'EMBASE | 2 | | |
| | | PAF15-04000003 | | JUNTA DRENAJE COLA | DRAIN PLUG GASKET | GUARNIZIONE DRENAGGIO | JOINT DE VIDANGE D'EMBASE | 1 | | |
| | | REC16911-ZZ5-003 | | FILTRO COMBUSTIBLE | FUEL FILTER | FILTRO COMBUSTIBILE | FILTRE À ESSENCE | 1 | | |
| | | BF60A | | REC06211-ZZ3-506 | REC19210-ZV5-003 | TURBINA | IMPELLER | GIRANTE | TURBINE | 1 |
| REC90752-ZV5-003 | | | | CHAVETA TURBINA | IMPELLER KEY | CHIAVE GIRANTE | CLAVETTE TURBINE | 1 | | |
| NGKLMAR6C-9 | | | | BUJÍA | SPARK PLUG | CANDELE | BOUGIE | 3 | | |
| PAGB/T91-2.5X30 | | | | PIN | PIN | PIN | GOUPILLE | 1 | | |
| PAF15-07000031 | | | | TERMOSTATO | THERMOSTAT | TERMOSTATO | TERMOSTAT | 1 | | |
| CMHBF35225KITA | | | | KIT ANODO | ANODE KIT | KIT ANODO | KIT ANODE | 1 | | |
| REC12-191833 | | | | JUNTA DRENAJE COLA | DRAIN PLUG GASKET | GUARNIZIONE DRENAGGIO | JOINT DE VIDANGE D'EMBASE | 2 | | |
| PAF15-04000003 | | | | JUNTA DRENAJE COLA | DRAIN PLUG GASKET | GUARNIZIONE DRENAGGIO | JOINT DE VIDANGE D'EMBASE | 1 | | |
| REC35-822626Q03 | | | | FILTRO DE ACEITE | OIL FILTER | FILTRO OLIO | FILTRE A HUILE | 1 | | |
| REC16911-ZZ5-003 | | | | FILTRO COMBUSTIBLE | FUEL FILTER | FILTRO COMBUSTIBILE | FILTRE À ESSENCE | 1 | | |
| BF75A BF90A (1200002) | | REC06211-ZW0-505 | REC06192-ZV1-305 | KIT TURBINA | IMPELLER KIT | KIT GIRANTE | KIT TURBINE | 1 | | |
| | | REC19300-ZV5-043 | | TERMOSTATO | THERMOSTAT | TERMOSTATO | TERMOSTAT | 1 | | |
| | | REC15400-RBA-F01 | | FILTRO DE ACEITE | OIL FILTER | FILTRO OLIO | FILTRE A HUILE | 1 | | |
| | | NGKDR7EA | | BUJÍA | SPARK PLUG | CANDELE | BOUGIE | 4 | | |
| | | PAGB/T91-2.5X30 | | PIN | PIN | PIN | GOUPILLE | 1 | | |
| | | REC12-191833 | | JUNTA DRENAJE COLA | DRAIN PLUG GASKET | GUARNIZIONE DRENAGGIO | JOINT DE VIDANGE D'EMBASE | 2 | | |
| | | PAF15-04000003 | | JUNTA DRENAJE COLA | DRAIN PLUG GASKET | GUARNIZIONE DRENAGGIO | JOINT DE VIDANGE D'EMBASE | 1 | | |
| | | CMHBF75115KITA | | KIT ANODO | ANODE KIT | KIT ANODO | KIT ANODE | 1 | | |
| | | REC16900-SA5-004 | | FILTRO COMBUSTIBLE | FUEL FILTER | FILTRO COMBUSTIBILE | FILTRE À ESSENCE | 1 | | |
| | | BF75D BF90D | | REC06211-ZY9-505 | REC06192-ZV1-000 | KIT TURBINA | IMPELLER KIT | KIT GIRANTE | KIT TURBINE | 1 |
| PAGB/T91-2.5X30 | | | | PIN | PIN | PIN | GOUPILLE | 1 | | |
| NGKIZFR6K11 | | | | BUJÍA | SPARK PLUG | CANDELE | BOUGIE | 4 | | |
| REC15400-RBA-F01 | | | | FILTRO DE ACEITE | OIL FILTER | FILTRO OLIO | FILTRE A HUILE | 1 | | |
| CMHBF75115KITA | | | | KIT ANODO | ANODE KIT | KIT ANODO | KIT ANODE | 1 | | |
| REC19300-ZV5-043 | | | | TERMOSTATO | THERMOSTAT | TERMOSTATO | TERMOSTAT | 1 | | |
| REC12-191833 | | | | JUNTA DRENAJE COLA | DRAIN PLUG GASKET | GUARNIZIONE DRENAGGIO | JOINT DE VIDANGE D'EMBASE | 2 | | |
| PAF15-04000003 | | | | JUNTA DRENAJE COLA | DRAIN PLUG GASKET | GUARNIZIONE DRENAGGIO | JOINT DE VIDANGE D'EMBASE | 1 | | |
| REC16900-SR3-004 | | | | FILTRO COMBUSTIBLE | FUEL FILTER | FILTRO COMBUSTIBILE | FILTRE À ESSENCE | 1 | | |
| REC16911-ZY3-010 | | | | FILTRO COMBUSTIBLE | FUEL FILTER | FILTRO COMBUSTIBILE | FILTRE À ESSENCE | 1 | | |
| BF115A BF130A | | REC06211-ZW5-505 | REC06192-ZV1-000 | KIT TURBINA | IMPELLER KIT | KIT GIRANTE | KIT TURBINE | 1 | | |
| | | REC15400-RBA-F01 | | FILTRO DE ACEITE | OIL FILTER | FILTRO OLIO | FILTRE A HUILE | 1 | | |
| | | NGKZFR7F | | BUJÍA | SPARK PLUG | CANDELE | BOUGIE | 4 | | |
| | | REC12-191833 | | JUNTA DRENAJE COLA | DRAIN PLUG GASKET | GUARNIZIONE DRENAGGIO | JOINT DE VIDANGE D'EMBASE | 2 | | |
| | | PAF15-04000003 | | JUNTA DRENAJE COLA | DRAIN PLUG GASKET | GUARNIZIONE DRENAGGIO | JOINT DE VIDANGE D'EMBASE | 1 | | |
| | | CMHBF75115KITA | | KIT ANODO | ANODE KIT | KIT ANODO | KIT ANODE | 1 | | |
| | | REC16911-ZY3-010 | | FILTRO COMBUSTIBLE | FUEL FILTER | FILTRO COMBUSTIBILE | FILTRE À ESSENCE | 1 | | |
| | | REC16900-SR3-004 | | FILTRO COMBUSTIBLE | FUEL FILTER | FILTRO COMBUSTIBILE | FILTRE À ESSENCE | 1 | | |
| | | BF135A BF150A | | REC06211-ZY5-505 | REC06192-ZY6-000 | KIT TURBINA | IMPELLER KIT | KIT GIRANTE | KIT TURBINE | 1 |
| | | | | PAGB/T91-2.5X30 | | PIN | PIN | PIN | GOUPILLE | 1 |
| REC15400-RBA-F01 | | | | FILTRO DE ACEITE | OIL FILTER | FILTRO OLIO | FILTRE A HUILE | 1 | | |
| NGKIZFR6K11 | | | | BUJÍA | SPARK PLUG | CANDELE | BOUGIE | 4 | | |
| REC12-191833 | | | | JUNTA DRENAJE COLA | DRAIN PLUG GASKET | GUARNIZIONE DRENAGGIO | JOINT DE VIDANGE D'EMBASE | 2 | | |
| PAF15-04000003 | | | | JUNTA DRENAJE COLA | DRAIN PLUG GASKET | GUARNIZIONE DRENAGGIO | JOINT DE VIDANGE D'EMBASE | 1 | | |
| CMHBF35225KITA | | | | KIT ANODO | ANODE KIT | KIT ANODO | KIT ANODE | 1 | | |
| REC16911-ZY3-010 | | | | FILTRO COMBUSTIBLE | FUEL FILTER | FILTRO COMBUSTIBILE | FILTRE À ESSENCE | 1 | | |
| BF175A BF200A BF225A | | | | REC06211-ZY2-506 | REC06192-ZY3-000 | KIT TURBINA | IMPELLER KIT | KIT GIRANTE | KIT TURBINE | 1 |
| | | | | REC15400-PLM-A01PE | | FILTRO DE ACEITE | OIL FILTER | FILTRO OLIO | FILTRE A HUILE | 1 |
| | | NGKIZFR6K11 | | BUJÍA | SPARK PLUG | CANDELE | BOUGIE | 6 | | |
| | | PAF15-07000031 | | TERMOSTATO | THERMOSTAT | TERMOSTATO | TERMOSTAT | 1 | | |
| | | PAGB/T91-2.5X30 | | PIN | PIN | PIN | GOUPILLE | 1 | | |
| | | REC12-191833 | | JUNTA DRENAJE COLA | DRAIN PLUG GASKET | GUARNIZIONE DRENAGGIO | JOINT DE VIDANGE D'EMBASE | 2 | | |
| | | PAF15-04000003 | | JUNTA DRENAJE COLA | DRAIN PLUG GASKET | GUARNIZIONE DRENAGGIO | JOINT DE VIDANGE D'EMBASE | 1 | | |
| | | CMHBF35225KITA | | KIT ANODO | ANODE KIT | KIT ANODO | KIT ANODE | 1 | | |
| | | REC16911-ZY3-010 | | FILTRO COMBUSTIBLE | FUEL FILTER | FILTRO COMBUSTIBILE | FILTRE À ESSENCE | 1 | | |

SISTEMA DE ALIMENTACIÓN Y FILTRACIÓN FUEL & FILTRATION SYSTEM

SISTEMA DI ALIMENTAZIONE E FILTRAZIONE SYSTÈME D'ALIMENTATION ET DE FILTRATION

BOMBA DE COMBUSTIBLE FUEL PUMP POMPA BENZINA POIRE À CARBURANT



BOMBA DE COMBUSTIBLE FUEL PUMP POMPA BENZINA POIRE À CARBURANT

Fabricada con elastómeros termoplásticos inyectados, resistentes al alcohol y rayos UV.s

Premium quality bulb resistance to alcohol as well as UV and ozone.

Fabbricata con elastomero termoplastico, resistente ai solventi e raggi UV.

Fabriqué avec des élastomères thermoplastiques injectés, résistant aux carburants et aux rayons UV.

| REF |  |  |
|---------|---|---|
| GS31187 | 1/4" = 6 mm | 1 |
| GS31090 | 5/16" = 8 mm | 1 |
| GS31095 | 3/8" = 9.5 mm | 1 |
| GS31090 | 5/16" = 8 mm | 1 |

GOLDENSHIP





LÍNEA DE COMBUSTIBLE FUEL LINE ASSEMBLY TUBO CARBURANTE TUYAU CARBURANT

Universal. Manguera resistente al alcohol.

Universal. Alcohol resistant hose.



Universale. Tubo resistente ai solventi.

Universel. Tuyau résistant à l'alcohol.

| REF |  |  |
|------------|---|---|
| GS31096 | 5/16" x 2 m | 1 |
| GS31097 | 3/8" x 2 m | 1 |
| GS31099 | 8 mm x 2 m | 1 |
| SIE18-8013 | 5/16" x 2 m | 1 |
| SIE18-8015 | 3/8" x 2 m | 1 |



SIE18-8013
SIE18-8015

| REF |  |  |
|---------|---|---|
| GS31189 | 3/8" x 2 m | 1 |

MADE IN THE USA **GOLDENSHIP**



| REF |  |  |
|---------|--|---|
| GS31183 | 6 mm x 2 m | 1 |

GOLDENSHIP

new





MANGUERA DE COMBUSTIBLE FUEL HOSE TUBO BENZINA TUYAU CARBURANT

Manguera «Trident» para líneas de combustible. Con refuerzo termoplástico que le permite excelente flexibilidad y resistencia a los rayos UV. Color gris. Resistente al alcohol. Especialmente indicado para motores fueraborda. Garantía: 3 años

Marine fuel hose (distribution and vent) for outboards. Fuel resistant thermo-plastic formulation with 2 spiral reinforcement provides excellent bendability and resistance to UV, aging and permeation by all marine fuels (gasoline/petrol and diesel) including alcohol blends. Warranty: 3 years

Tubo «Trident» per linea combustibile. Con rinforzo termoplastico che gli permette un'eccellente flessibilità e resistenza ai raggi UV. Colore grigio. Resistente ai solventi. Indicato per i motori fuoribordo. Garanzia: 3 anni

Tuyau «Trident» pour carburant. Avec renfort thermoplastique qui permet une excellente flexibilité et résistance aux rayons UV. Gris. Résistant à l'alcohol. Convient particulièrement aux moteurs hors-bord. Garantie: 3 ans

| REF |  |  |  |  |
|-------------|---|---|---|---|
| TRI305-0566 | 5/16" = 7,92 mm | 15 m | 1 | SAEJ1527 |
| TRI305-0386 | 3/8" = 9,53 mm | 15 m | 1 | ISO-8469 B1 CE |



TRIDENT



De goma para diesel y gasolina sin plomo. Ideal para fueraborda. Refuerzos textiles internos. Muy flexible. Contenido aromático 50%

Rubber Hose suitable for loading mineral oils, diesel and unloaded fuel

In gomma per diesel e benzina senza piombo. Ideale per motori fuoribordo. Tessuto interno rinforzato. Molto flessibile.

Caoutchouc pour diesel et essence sans plomb. Idéal pour le hors-bord. Renforts textiles internes. Très flexible

CARBUPOMP/10NL

| REF |  |  |  |  |  |  |
|---------|---|---|---|---|---|---|
| GS35031 | 6x12 | 10 bar | 50 mm | -25°C → 80°C | 50 m | ISO R1307 |
| GS35032 | 8x15 | 10 bar | 65 mm | | 50 m | |

H.T. CARBUPOMP/10NL - WP 30 BAR - R<1M Q1H - ISO R1307

ht hoses technology

MUELLE TUBO COMBUSTIBLE

SPRING, FUEL PIPE

MOLLA TUBO COMBUSTIBLE

RESSORT, TUYAU DE CARBURANT

new

| REF |
|---------------|
| PAF4-04000030 |
| PAF4-05000010 |



ABRAZADERA

CLAMP SMALL

FASCETTE

COLLIER

new

| REF | |
|-----------------|------|
| REC650-24351-51 | 6 mm |
| REC6E5-24351-51 | 8 mm |



| REF | | |
|--------------------|--------|----|
| REC09401-11425 | 6-8 mm | 1 |
| REC09401-11425BULK | 6-8 mm | 25 |



ADPATADOR LÍNEA DE COMBUSTIBLE

COUPLER

ADATTATORE

RACCORD COUPLEUR

| REF | |
|-----------------|--------------------|
| REC22-8M0001721 | Ø 11 mm --> Ø 9 mm |



COMPONENTES TANQUE Y CONECTORES

FUEL TANK COMPONENTS & CONNECTORS

COMPONENTI SERBATOIO E CONETTORI

COMPOSANTS ET CONNECTEURS DU RESERVOIR

CONECTOR DE DEPÓSITO

TANK CONNECTOR

ATTACCO SERBATOIO

RACCORDS DE RESERVOIR

Fabricado en latón.

Made in machined brass.

Fabbricato in ottone.

Coude MF 1/4" NPT en laiton.

| REF | | |
|---------|----------|---|
| GS31068 | 1/4" NPT | 1 |



Para conectar dos motores a un sólo depósito, o viceversa. Fabricado en latón.

To connect two motors to a single tank, or vice versa. Made in machined brass.

Per collegare due motori a un singolo serbatoio o viceversa. Fabbricato in ottone.

Té en laiton, pour connecter deux moteurs à un même réservoir, ou inversement.

| REF | | |
|---------|----------|---|
| GS31069 | 1/4" NPT | 1 |



| REF | OEM | |
|------------------|--------------------------------|--|
| REC17710-ZW9-033 | 17710-ZW9-023 17710-ZW9-033 | |
| | BF4 --> BF130 HP | |

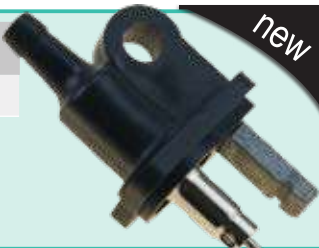

new

| REF | OEM | |
|---------|-----------------------------------|------|
| GS31030 | 17660-ZV5-902 | 3/8" |
| | antigüos old vecchio ancien | |



GOLDENSHIP

| REF | OEM | |
|---------|---------------------------------|------------------|
| GS31031 | 17660-ZV5-A00 17660-ZW9-003 | 1/4" NPT 3/8" |
| | nuevos news nuovo nouveau | |



GOLDENSHIP

| REF | OEM | |
|---------|-----------------------------------|------|
| GS31034 | 17650-921-003ZB | 3/8" |
| | antigüos old vecchio ancien | |



GOLDENSHIP

| REF | OEM |  |
|---------|----------------|---|
| GS31033 | 116977-ZV5-A00 | 1/4" NPT |



nuevos | news | nuovo | nouveau





| REF | OEM |  |
|---------|----------------|---|
| GS31032 | 116977-ZV5-900 | 1/4" NPT |

antigüos | old | vecchio | ancien

PASAMAMPAROS

THRU HULL

PASSASCAFO

PASSE-CLOISON

Para atravesar mamparos de hasta 12 mm. Fabricado en latón.

For bulkhead up to 12 mm. Made in machined brass.

Per attraversare paratie fino a 12 mm. Fabricato in ottone.

Pour traverser des cloisons jusqu'à 12 mm. Fait en laiton.

| REF |  |  |
|---------|---|---|
| GS31064 | 3/8" | 1 |



FILTRO DE COMBUSTIBLE Y ELEMENTOS

FUEL FILTERS AND ELEMENTS

FILTRI BENZINA E RACCORDI

FILTRE A ESSENCE ET CARTOUCHE DE RECHANGE

BRACKET

BRACKET

SUPPORTO

TÊTE DE FILTRE À ESSENCE

Con 2 tapones de bronce y 2 tubos de extensión. (2 entradas y 2 salidas).

With 2 brass plugs and 2 extension tubes. (2 inputs & 2 outputs).

Con 2 tappi di bronzo e 2 tubi di estensione. (2 ingressi entrata carburante e 2 uscite carburante).

Avec 2 bouchons en bronze et 2 tubes d'extension. (2 entrées et 2 sorties).

| REF |  |  |
|--------------|---|---|
| REC25000 | 1/4" | AL |
| REC25010 | 1/4" | INOX /SS AISI316 |
| REC25020 | 3/8" | AL |
| REC25030 | 3/8" | INOX /SS AISI316 |
| RECOBBRACKET | 1/4" | Plástico Plastic Plastica Plastique |



REC25000 - REC25020



REC25010 - REC25030



RECOBBRACKET

FILTRO COMBUSTIBLE SEPARADOR DE AGUA

WATER SEPARATING FUEL FILTER

FILTRO SEPARATORE ACQUA-BENZINA

FILTRE SEPARATEUR EAU-ESSENCE

| REF | RO OEM | MICRON |  |
|-----------------|-----------------|--------|---|
| REC24942 | 06177-ZX2-000HE | 10 | 4 ^{7/16} " 11 cm |
| REC35-802893Q01 | | 10 | 3 ^{3/4} " |
| REC855686 | | 28 | 4 ^{7/16} " |
| REC35-802893Q | | 25 | 3 ^{3/4} " |
| RACPF5510 | | 10 | 4 ^{7/16} " |



RACPF5510



REC24942



REC35-802893Q01



REC855686



REC35-802893Q



Filtro original.

OEM filter.

Filtro benzina originale.

Filtre à essence d'origine

| REF | MICRON |  |
|--------------|--------|---|
| RM35-802893Q | 10 | 3 ^{3/4} " |



FILTRO CON BRACKET

Con 2 tapones de bronce y 1 tubo de extensión.

OEM FILTER WITH BRACKET



With 2 brass plugs & 1 extension tube.

FILTRO BENZINA CON SUPPORTO

Con 2 tappi di bronzo e 1 tubo di estensione.

FILTRE A ESSENCE AVEC SUPPORT

avec 2 bouchons en bronze et 1 tube d'extension

| REF | RO OEM | MICRON |  |  | BRACKET |
|----------|-----------------|--------|---|---|---------|
| REC24950 | | 25 | 1/4" | 50 GPH | AL |
| REC24952 | 06177-ZX2-000HE | 10 | 1/4" | 50 GPH | AL |





FILTRO DECANTADOR DE COMBUSTIBLE COMPLETO CON VASO TRASPARENTE

COMPLET FUEL FILTER WITH TRANSPARENT BOWL



FILTRO DI DECANTAZIONE BENZINA COMPLETO CON VASCHETTA TRASPARENTE

FILTRE DÉCANTEUR ESSENCE AVEC BOL TRANSPARENT

| REF |  |  |
|----------------|---|---|
| RAC320R-RAC-01 | | AL |
| RAC320R-RAC-03 | RACS3213 LENS3213 | Plástico Plastic Plastica Plastique |

RACOR



| REF |  |  |  |
|-------------|--|---|---|
| RECOBIFALU | | | AL |
| RECOBFILTER | RECOBELEMENT LENS3213 | 150 l/h | Plástico Plastic Plastica Plastique |

RECMAR





FILTRO CON BOMBA CEBADORA

FILTER WITH PRIMING PUMP

FILTRO CON PEMPETA PER RIEMPIRE

FILTRE A ESSENCE AVEC POMPE D'AMORCAGE

| REF |  | MICRON |  |  |  |
|----------------|---|--------|---|---|---|
| RAC490R-RAC-01 | RACS3227 LENS3227 | 10 | 340 l/h | 3/8" NPTF | 150 hp |

RACOR



FILTRO DECANTADOR GASOLINA

COMPLETE FUEL FILTER

FILTRO DECANTATORE BENZINA

FILTRE DÉCANTEUR ESSENCE

Filtro de combustible con braket.

Complete fuel filter with braket.

Filtro combustibile con supporto.

Filtre à carburant avec support.

| REF |  | MICRON |
|-------------|---|-----------------------|
| RAC23299-10 | RAC23289-10 | 130 HP (4 T/ Strokes) |

RACOR



| REF | MICRON |  |
|-----------------|--------|---|
| PAF40-0701000E1 | 10 | 70 hp |



Ø 6 mm



new

| | | | | | | |
|----------------|-----|---|------------|--------|---|---|
| REF | OEM |  | R.O. / OEM | MICRON |  |  |
| REC90794-46866 | | REC90794-46868 | | 10 | 117 l/h | 175 hp |



LLAVE PARA FILTRO
 FILTER KEY
 CHIAVE DA FILTRO
 CLÉ A FILTRE

REF
 RECYS-225-15



RACOR



| REF | RAC120R-RAC-01 | RAC320R-RAC-01 | RAC320R-INOX-01 RAC320R-RAC-03 | RAC320R-RAC-02 RAC320R-INOX-02 |
|--|----------------------|----------------------|-----------------------------------|-----------------------------------|
| RO /OEM | 06178-ZW1-030GH | | 06177-ZW1-801AH | |
| FLUJO MÁXIMO MAX. FLOW FLUSSO MASSIMO FLUX MAXIMAL | 114 l/h 30 gph | 340 l/h 60 gph | 340 l/h 60 gph | 340 l/h 60 gph |
| ELEMENTO ELEMENT ELEMENTO ELEMENT | RACS3240 LENS3240 | RACS3213 LENS3213 | RACS3213 LENS3213 | RACS3220UL |
| CAZOLETA TRANSPARENTE (sólo se recomienda para fueraborda.) CLEAR BOWL (Just for outboards) VASCHETTA TRASPARENTE (Solo nei fuoribordo.) BOL TRANSPARENT (uniquement recommandé pour le hors-bord.) | 17670-ZW1-030GH | | 17670-ZW1-801AH | |
| ROSCAS CENTRALES CENTRAL THREADS FILETTO CENTRALE TAILLE DU FILETAGE POUR LA CARTOUCHE | M18 x 1.5 | 1 1/4" | 1 1/4" | 1 1/4" |
| TAMAÑO ROSCA CABEZA HEAD PORT SIZE DIMENSIONE VITE TESTA TAILLE DU FILETAGE POUR LES RACCORDS | 1/4-18 NPTF | 1/4-18 NPTF | 1/4-18 NPTF | 1/4-18 NPTF |
| ALTURA X Ø HEIGHT X Ø ALTEZZA X Ø HAUTEUR X Ø | 166 x 81 mm | 238 x 102 mm | 238 x 102 mm | 238 x 102 mm |
| PESO WEIGHT PESO POIDS | 0,5 kg | 0,9 kg | 0,9 kg | 0,9 kg |
| CAIDA DE PRESIÓN PRESSURE DROP CADUTA DI PRESSIONE CHUTE DE PRESSION | 0.15 PSI 0.01 bar | 0.61 PSI 0.04 bar | 0.61 PSI 0.04 bar | 0.61 PSI 0.04 bar |
| PRESIÓN MÁXIMA MAX. PRESSURE PRESSIONE MASSIMA PRESSION MAXIMALE | 7 PSI 0.05 bar | 7 PSI 0.05 bar | 7 PSI 0.05 bar | 7 PSI 0.05 bar |
| DESMONTAJE CARTUCHO-CAZOLETA ELEMENT REMOVAL UNDERBOWL RIMOZIONE DELLA CARTUCCIA DEMONTAGE DE LA CARTOUCHE | 25,4 mm 1" | 25,4 mm 1" | 25,4 mm 1" | 25,4 mm 1" |
| TEMPERATURA DE TRABAJO OPERATING TEMPERATURE TEMPERATURA DI LAVORO TEMPERATURE DE TRAVAIL | -40°C +124°C | | | |

| RÁCORES | | RACORS | | RACCORDI | | | RACCORDS | | | | |
|---------|----------|----------------|---|----------|----------|----------------|----------|---------|----------|---------------|---|
| REF | | | | | | | | | | | |
| GS31065 | 1/4" NPT | 3/8" = 9.5 mm | 1 | GS31066 | 1/4" NPT | 5/16" = 7.9 mm | 2 | GS31067 | 1/4" NPT | 3/8" = 9.5 mm | 2 |
| GS31166 | 1/4" NPT | 5/16" = 7.9 mm | 2 | | | | | | | | |
| GS31155 | 3/8" NPT | 3/8" = 9.5 mm | 2 | | | | | | | | |
| GS31156 | 3/8" NPT | 5/16" = 7.9 mm | 2 | | | | | | | | |
| GS31157 | 3/8" NPT | 1/4" = 6.4 mm | 2 | | | | | | | | |







| LLAVES PARA FILTRO | | FILTER KEY | | CHIAVE DA FILTRO | | CLÉ À FILTRE | |
|--------------------|--|------------|--|------------------|-------------|--------------|--|
| REF | | | | REF | | | |
| RACRK22628 | | | | REC70720 | 65 - 110 mm | | |





| FILTRO COMBUSTIBLE PARA MONTAJE EN LÍNEA | | IN-LINE FUEL FILTER | | FILTRO BENZINA PER MONTARE IN LINEA | | FILTRE A ESSENCE EN LIGNE | |
|--|---------|---------------------|-----------------------|---------------------------------------|-----------------|---------------------------|--|
| REF | | | | REF | OEM | | |
| GS31001 | 50 l/h | 6-8 mm | plástico plastic | REC16910-ZV4-015 | 16910-ZV4-015 | | |
| GS31002 | 150 l/h | 8-10 mm | plástica plastique | BF15AM/B/D3/DK2 | BF90DK0/DK2/DK4 | | |
| | | | | BF8C/CX/B1/B2/D1/D2/ P8B1/P8B2/DK2 | BF100A | | |
| | | | | BF9.9AH/AK/AM/B/DK2/D1 | BF60A/AK1 | | |
| | | | | BF25D4/DK2/A/A1/AX | BF80A | | |
| | | | | BF30D4/DK2/A/A1/AX | | | |
| | | | | BF20A/AX/D3 | | | |
| | | | | BF10B1/D1/P10B1/DH/DK2 | | | |
| | | | | BF75DK0/DK2/DK3 | | | |
| | | | | BF40D/DK2 | | | |
| | | | | BF50D/DK2 | | | |



| REF | | | |
|---------|-------------|--|---|
| GS30435 | 6, 8, 10 mm | metal + cristal metal + crystal metal + cristal métal + verre | 1 |





| REF | OEM |
|-----------------------------------|---------------|
| REC16900-SA5-004 | 16900-SA5-004 |
| BF35AM | |
| BF40B/B2/BX/A4/A1/A2/AX/A3/AY | |
| BF45AM | |
| BF75A1/AT/AV/AX/A2/A3 | |
| BF90A1/AF/AV/AX/A2/A3 | |
| BF50A4/A1/A2/AX/A3/AY (14ZW00E1M) | |



| REF | OEM |
|----------------------------|---------------|
| REC16910-GB2-005 | 16900-GB2-005 |
| BF4.5B/BX/B2/B4/B6 | |
| BF5A1/AH/AK/AM/AX/A2/A3/A4 | |
| BF6B/BX/D6 | |
| BF8AX/BX/AH/AK/AM | |
| BF50F | |
| BF75F | |
| BF100F | |



| REF | OEM | | | |
|----------|-----|-------|-------|-----------|
| REC40145 | | 1/4" | 1/4" | plástico |
| REC40155 | | 5/16" | 5/16" | plastic |
| REC40165 | | 3/8" | 3/8" | plástica |
| REC40135 | | 5/16" | 3/8" | plastique |



| REF | OEM |
|------------------------|---------------|
| REC16900-SR3-004 | 16900-SR3-004 |
| BF115A1 / A2 / A3 / AX | |
| BF130A1 / A2 / A3 / AX | |
| Series #14ZW50E1M | |



| REF | OEM |
|------------------|--------------------------------|
| REC16901-ZY3-003 | 16901-ZY3-003 16911-ZY3-003 |



new

- BF115
- BF135
- BF150
- BF175
- BF200
- BF225
- BF250

| REF | OEM |
|------------------|---------------|
| REC16911-ZZ5-003 | 16911-ZZ5-003 |



new

- BF40D, DK2, DK4, E
- DF50D, DK2, DK4
- BF60A, AK1
- BFF60A, AK1

| REF | OEM |
|------------------|---------------|
| REC16911-ZY3-010 | 16911-ZY3-010 |



- BF80A
- BF100A
- BF90D2 / D4 / DK0
- BF75DK2 / DK3 / DK0
- BF150AK2 / A4
- BF135AK2 / A4
- BF225AK2 / AK3 / AK1 / A6
- BF200AK2 / AK3 / AK1 / A6
- BF175AK2 / AK3 / AK1 / A6
- BF250A
- BF115D / DK1 / A2
- BF130 A2

| REF | OEM |
|------------------|---------------|
| REC16010-ST5-993 | 16900-ST5-993 |



- BF115
- BF130 / AX / AY / A1
- Series #14ZW50E1M

| REF | OEM |  |  |
|---------------|-----------------|---|---|
| RAC025-RAC-02 | 06176-ZW3-801AH | 1/4" 18 NPTF | 1/4" 18 NPTF |



new

- BF5
- BF20

ACEITE OIL OLIO HUILES

| REF |  |  | |
|------------|---|---|-----------|
| REC2TU6 | 1 L | 6 | 2 STROKES |
| REC2TU3 | 5 L | 3 | TC-W3 |
| REC5W40U6 | 1 L | 6 | SAE 5W40 |
| REC5W40U3 | 5 L | 3 | |
| REC10W30U6 | 1 L | 6 | SAE 10W30 |
| REC10W30U3 | 5 L | 3 | |
| REC10W40U6 | 1 L | 6 | SAE 10W40 |
| REC10W40U3 | 5 L | 3 | |
| REC25W40U3 | 5 L | 3 | SAE 25W40 |
| REC80W90U3 | 5 L | 3 | |
| REC80W90U6 | 1 L | 6 | SAE 80W90 |



new



| REF |  |  | |
|------------------|---|---|-----------|
| RM92-858026QB1U6 | 1 L | 6 | 2 STROKES |
| RM92-858027QB1U3 | 3,8 L | 3 | |
| RM92-8M0086220U6 | 1 L | 6 | SAE 10W30 |
| RM92-8M0086221U3 | 4 L | 3 | |



RM92-858026QB1U6 RM92-858027QB1U3 RM92-8M0086220U6 RM92-8M0086221U3

FILTRO DE ACEITE

OIL FILTER

FILTRO OLIO

FILTRE A HUILE

FILTROS DE ACEITE

OIL FILTER

FILTRO OLIO

FILTRES A HUILE

| REF | OEM |
|-----------------|----------------|
| REC35-822626Q03 | 15400-PM3-004 |
| | 15400-PFB-014, |
| | 15400-PFRB-007 |
| | 15400-ZW4-003 |
| | 15400-PJ7-015 |
| | 15400-PM3-405 |
| | 15400-PFB-004 |



| | | |
|---|---------|---------|
|  BF25DE4 | BF15DK3 | BF50DK2 |
| BF30D4 | BF20D3 | BF50DK4 |
| BF8B2 | BF20DK2 | BF8D4 |
| BF8D2 | BF20DK3 | BFP10D2 |
| BF10B2 | BF25DK2 | |
| BF10D2 | BF30DK2 | |
| BF10D4 | BF40DK2 | |
| BF15D3 | BF40DK4 | |

| REF | OEM |
|--------------------|-----------------|
| REC15400-PLM-A01PE | 15400-PH1-F03 |
| | 15400-POH-305PE |
| | 15400-POH-305 |
| | 15400-ZJI-004 |
| | 15400-PLM-A01PE |
| | 15400-RTA-003 |
| | 15400-RTA-004 |



| | | | | |
|--|----------|----------|---------|-----------|
|  BF100A | BF150AK2 | BF200AK2 | BF250A | BF90DK0 |
| BF100AK1 | BF175A6 | BF200AK3 | BF250D | BF90DK2 |
| BF115A2 | BF175AK1 | BF200D | BF75DK0 | BF90DK4 |
| BF115D | BF175AK2 | BF225A6 | BF75DK2 | BF90DK5 |
| BF115DK1 | BF175AK3 | BF225AK1 | BF75DK3 | BFT100AK1 |
| BF135A4 | BF175D | BF225AK2 | BF75DK4 | BF80AK1 |
| BF135AK2 | BF200A6 | BF225AK3 | BF80A | |
| BF150A4 | BF200AK1 | BF225D | BF80AK1 | |

| REF | OEM |
|------------------|---------------|
| REC15400-RBA-F01 | 15400-RBA-F01 |



| | |
|--|--|
|  V-TEC150 | |
| V-TEC175 | |

| REF | OEM |
|-----------------|---------------|
| REC5GH-13440-00 | 15400-PFB-007 |



| | |
|--|--|
|  BF25 | |
| BF30 | |
| BF40 | |

GUÍA FILTROS DE ACEITE

OIL FILTER GUIDE

GUIDA FILTRO OLIO

GUIDE DES FILTRES A HUILE

|  | REF |
|---|-----------------|
| BF8B2 | |
| BF8D2 | REC35-822626Q03 |
| BF8D4 | |
| BF10B2 | |
| BF10D2 | REC35-822626Q03 |
| BF10D4 | |
| BFP10D2 | |
| BF15D3 | REC35-822626Q03 |
| BF15DK3 | |
| BF20D3 | |
| BF20DK2 | REC35-822626Q03 |
| BF20DK3 | |
| BF25 | REC5GH-13440-00 |
| BF25DE4 | REC35-822626Q03 |
| BF25DK2 | |
| BF30 | REC5GH-13440-00 |
| BF30D4 | REC35-822626Q03 |
| BF30DK2 | |
| BF40 | REC5GH-13440-00 |
| BF40DK2 | REC35-822626Q03 |
| BF40DK4 | |

|  | REF |
|---|------------------------------|
| BF50DK2 | REC35-822626Q03 |
| BF50DK4 | |
| BF75DK2 | |
| BF75DK3 | M20 x 1.5 REC15400-PLM-A01PE |
| BF75DK4 | |
| BF75DK0 | |
| BF80A | M20 x 1.5 REC15400-PLM-A01PE |
| BF80AK1 | |
| BFT80AK1 | |
| BF90DK2 | |
| BF90DK4 | M20 x 1.5 REC15400-PLM-A01PE |
| BF90DK5 | |
| BF90DK0 | |
| BF100A | |
| BF100AK1 | M20 x 1.5 REC15400-PLM-A01PE |
| BFT100AK1 | |
| BF115A2 | |
| BF115D | M20 x 1.5 REC15400-PLM-A01PE |
| BF115DK1 | |
| BF135A4 | M20 x 1.5 REC15400-PLM-A01PE |
| BF135AK2 | |

|  | REF |
|---|------------------------------|
| BF150A4 | M20 x 1.5 REC15400-PLM-A01PE |
| BF150AK2 | |
| BF175A6 | |
| BF175AK1 | M20 x 1.5 REC15400-PLM-A01PE |
| BF175AK2 | |
| BF175AK3 | |
| BF175D | |
| BF200A6 | |
| BF200AK1 | M20 x 1.5 REC15400-PLM-A01PE |
| BF200AK2 | |
| BF200AK3 | |
| BF200D | |
| BF225A6 | |
| BF225AK1 | M20 x 1.5 REC15400-PLM-A01PE |
| BF225AK2 | |
| BF225AK3 | |
| BF225D | |
| BF250A | M20 x 1.5 REC15400-PLM-A01PE |
| BF250D | |
| V-TEC150 | M20 x 1.5 REC15400-RBA-F01 |
| V-TEC175 | |

BOMBA DE COMBUSTIBLE ELECTRICA

ELECTRIC FUEL PUMP

POMPA BENZINA ELETTRICA

POMPE À ESSENCE ÉLECTRIQUE

| REF | OEM |
|------------------|--------------------------------|
| REC16735-ZW5-003 | 16735-ZW5-003 16735-ZY3-004 |

 BF100A, AK1
BTF100AK1
BF115A1, A2, A3, AX
BF130A1, A2, AX
BF135A4, AK2
BF150A4, AK2
BF75DK0, DK2, DK3, DK4
BF90DK0, DK2, DK4, DK5

BF80A, AK1
BTF80AK1
BF175D, A3, A6, AK1, AK2, AK3
BF200D, A2, A3, A6, AK1, AK2, AK3
DF225D, A2, A3, A6, AK1, AK2, AK3
BF250D, A



new

BOMBA DE COMBUSTIBLE MECANICA

MECHANICAL FUEL PUMP

POMPA BENZINA MECCANICA

POMPE À ESSENCE MECANIQUE

| REF | OEM |
|------------------|--------------------------------|
| REC16700-ZW1-004 | 16700-ZW1-004 16700-ZV5-003 |

 BF20A, AX, A2
BF25A, A1, AX
BIF35AM
BF40B, B2, BX, A, A1, A2, AX, AY
BF45AM
BF30A, A1, AX
BF75A1, AT, AV, AX, A2
BF90A1, AT, AV, AX, A2
BF50A, A1, A2, AX, AY



new

INYECTORES

INJEKTOR

INIETTORE

INJECTEURS

| REF | OEM |
|------------------|---------------|
| REC06164-PCA-000 | 06164-PCA-000 |

 BF115AX
BF130AX



new

CARBURADOR

CARBURETOR

CARBURATORE

CARBURATEUR

AGUJA CARBURADOR

CARBURETOR, NEEDLE VALVE

SPILLO CONICO CARBURATORE

POINTEAU CARBURATEUR

| REF | OEM |
|------------------|---------------|
| REC16011-881-741 | 16011-881-741 |

 BF5 (-2003)
BF8
BF75 (-1997)
BF100 (-1997)



| REF | OEM |
|------------------|---------------|
| REC16011-ZV4-005 | 16011-ZV4-005 |

 BF8 (2001+)
BF9.9
BF15
BF20 (2003+)
BF25
BF30

BF35 (1997)
BF40
BF45 (1997)
BF50
BF75 (1997+)
BF90 (1997+)



KITS CARBURADORES

CARBURETOR KITS

KIT CARBURATORI

KIT CARBURATEUR

| REF | OEM |
|------------------|---------------------------|
| REC06160-ZV4-U11 | 06160-ZV4-U11 Honda KIT 1 |

BF9.9 (2000+)
BF15 (2002+)

| REF | OEM |
|------------------|--------------------------|
| REC16010-ZW9-003 | 16010-ZW9-003 Honda KIT2 |

BF9.9 (2001+)
BF15 (2003+)

| REF | OEM |
|------------------|--------------------------|
| REC16010-ZV4-005 | 16010-ZV4-005 Honda KIT3 |

BF75 (1997+)
BF90 (1997+)

| REF | OEM |
|------------|------------|
| REC18-7053 | Honda KIT4 |

BF8 (1996+)
BF75 (1996+)
BF100 (1996+)

GUÍA CARBURADORES

GUIDE CARBURETORS

GUIDA CARBURATORI

GUIDE DES CARBURATEURS





















| | KIT |
|--------------------------------|--------------------------------------|
| BF8C, CX | REC16010-ZV4-005 |
| BF8B1, B2, D1, D2, D3, D4, DK2 | REC16010-ZW9-003 |
| BF8 (2001+) | REC18-7053 |
| BFP8B1, B2, D1, D2, D3 | REC16010-ZW9-003 |
| BF9.9 | REC18-7053 |
| BF9.9AH, AK, AM, AX, AY, B, BX | REC16010-ZV4-005 |
| BF9.9D1, D2, D3, DK2 | REC16010-ZW9-003 |
| BFP9.9D, D1, D2 | REC16010-ZW9-003 |
| BF10B1, B2, D1, D2, D4, K2 | REC16010-ZW9-003 |
| BFP10B1, B2, D1, D2 | REC16010-ZW9-003 |
| BF15 | REC18-7053 |
| BF15A1, A2, A3 | REC06160-ZV4-U11 REC16010-ZV4-005 |
| BF15AH, AM, AX, AY | REC16010-ZV4-005 |
| BF15B, B2, BX | REC16010-ZV4-005 |
| BF15D3, DK2, DK3 | REC16010-ZW9-003 |
| BF20 (2003+) | REC18-7053 |
| BF20A, A2, AX | REC16010-ZV4-005 |

| | KIT |
|--|------------------|
| BF20D3, DK2, DK3 | REC16010-ZW9-003 |
| BF25 | REC18-7053 |
| BF25A, A1, A2, A3, AX, D4, DK2 | REC16010-ZV4-005 |
| BF30 | REC18-7053 |
| BF30A, A1, A2, A3, AX, D4, DK2 | REC16010-ZV4-005 |
| BF35 (1997) | REC18-7053 |
| BF35AM | REC16010-ZV4-005 |
| BF40 | REC18-7053 |
| BF40A, A1, A2, A3, A4, AX, AY, B, B2, BX | REC16010-ZV4-005 |
| BF45 (1997) | REC18-7053 |
| BF45AM | REC16010-ZV4-005 |
| BF50 | REC18-7053 |
| BF50A, A1, A2, A3, A4, AX, AY | REC16010-ZV4-005 |
| BF75 (1997+) | REC18-7053 |
| BF75A1, A2, A3, AT, AV, AX | REC16010-ZV4-005 |
| BF90 (1997+) | REC18-7053 |
| BF90A1, A2, A3, AT, AV, AX | REC16010-ZV4-005 |



SISTEMA ELÉCTRICO ELECTRIC SYSTEM

SISTEMA ELETTRICO SYSTÈME ÉLECTRIQUE

| SENSORES | SENSORS | SENSORE | CAPTEURS | | | | | | | | | | | | | | | | | | | | | | | | | | | | | | | | | | | | | | |
|--|----------------------------|-----------------------------------|--|---------------|---|----------|--|---|--|---|---|---|---|--|--|--|--|--|--|---|--|---|--|---|--|-------|--|-------|--|--|--|--|--------------|--|-----------------------|--|-----------------------|--|-----------|--|--|
| SENSOR MAP | MAP SENSOR | SENSORE MAP | CAPTEUR MAP | | | | | | | | | | | | | | | | | | | | | | | | | | | | | | | | | | | | | | |
| <table border="1"> <thead> <tr> <th>REF</th> <th>OEM</th> </tr> </thead> <tbody> <tr> <td>REC37830-PGK-A01</td> <td>37830-PGK-A01</td> </tr> <tr> <td> BF135A4</td> <td></td> </tr> <tr> <td> BF150A4</td> <td></td> </tr> <tr> <td> BF175A3, A6</td> <td></td> </tr> <tr> <td> BF200A2, A3, A6</td> <td></td> </tr> <tr> <td> BF225A2, A3, A6</td> <td></td> </tr> </tbody> </table>  | REF | OEM | REC37830-PGK-A01 | 37830-PGK-A01 |  BF135A4 | |  BF150A4 | |  BF175A3, A6 | |  BF200A2, A3, A6 | |  BF225A2, A3, A6 | | | <table border="1"> <thead> <tr> <th>REF</th> <th>OEM</th> </tr> </thead> <tbody> <tr> <td>REC37830-PNC-003</td> <td>37830-PNC-003</td> </tr> <tr> <td> BF40DK2, D</td> <td></td> </tr> <tr> <td> BF50DK2, D</td> <td></td> </tr> <tr> <td> BF75, DK0, DK2</td> <td></td> </tr> <tr> <td> BF90DK0, DK2</td> <td></td> </tr> </tbody> </table>  | REF | OEM | REC37830-PNC-003 | 37830-PNC-003 |  BF40DK2, D | |  BF50DK2, D | |  BF75, DK0, DK2 | |  BF90DK0, DK2 | | | | | | | | | | | | | | |
| REF | OEM | | | | | | | | | | | | | | | | | | | | | | | | | | | | | | | | | | | | | | | | |
| REC37830-PGK-A01 | 37830-PGK-A01 | | | | | | | | | | | | | | | | | | | | | | | | | | | | | | | | | | | | | | | | |
|  BF135A4 | | | | | | | | | | | | | | | | | | | | | | | | | | | | | | | | | | | | | | | | | |
|  BF150A4 | | | | | | | | | | | | | | | | | | | | | | | | | | | | | | | | | | | | | | | | | |
|  BF175A3, A6 | | | | | | | | | | | | | | | | | | | | | | | | | | | | | | | | | | | | | | | | | |
|  BF200A2, A3, A6 | | | | | | | | | | | | | | | | | | | | | | | | | | | | | | | | | | | | | | | | | |
|  BF225A2, A3, A6 | | | | | | | | | | | | | | | | | | | | | | | | | | | | | | | | | | | | | | | | | |
| REF | OEM | | | | | | | | | | | | | | | | | | | | | | | | | | | | | | | | | | | | | | | | |
| REC37830-PNC-003 | 37830-PNC-003 | | | | | | | | | | | | | | | | | | | | | | | | | | | | | | | | | | | | | | | | |
|  BF40DK2, D | | | | | | | | | | | | | | | | | | | | | | | | | | | | | | | | | | | | | | | | | |
|  BF50DK2, D | | | | | | | | | | | | | | | | | | | | | | | | | | | | | | | | | | | | | | | | | |
|  BF75, DK0, DK2 | | | | | | | | | | | | | | | | | | | | | | | | | | | | | | | | | | | | | | | | | |
|  BF90DK0, DK2 | | | | | | | | | | | | | | | | | | | | | | | | | | | | | | | | | | | | | | | | | |
| <table border="1"> <thead> <tr> <th>REF</th> <th>OEM</th> </tr> </thead> <tbody> <tr> <td>REC37830-RNA-A01</td> <td>37830-RNA-A01</td> </tr> </tbody> </table>  | REF | OEM | REC37830-RNA-A01 | 37830-RNA-A01 | <table border="1"> <thead> <tr> <th>REF</th> <th>OEM</th> </tr> </thead> <tbody> <tr> <td> BF100A, AK1</td> <td></td> </tr> <tr> <td> BFT100AK1</td> <td></td> </tr> <tr> <td> BF40E</td> <td></td> </tr> <tr> <td> BF80A, AK1</td> <td></td> </tr> <tr> <td> BF75DK3, DK4</td> <td></td> </tr> <tr> <td> BF90DK4, DK5</td> <td></td> </tr> <tr> <td> BF60A</td> <td></td> </tr> <tr> <td> BF115D, DK1</td> <td></td> </tr> </tbody> </table> | REF | OEM |  BF100A, AK1 | |  BFT100AK1 | |  BF40E | |  BF80A, AK1 | |  BF75DK3, DK4 | |  BF90DK4, DK5 | |  BF60A | |  BF115D, DK1 | | <table border="1"> <thead> <tr> <th>REF</th> <th>OEM</th> </tr> </thead> <tbody> <tr> <td>BF40D</td> <td></td> </tr> <tr> <td>BF135A4, AK2</td> <td></td> </tr> <tr> <td>BF50D</td> <td></td> </tr> <tr> <td>BF150A4, AK2</td> <td></td> </tr> <tr> <td>BF175D, AK1, AK2, AK3</td> <td></td> </tr> <tr> <td>BF200D, AK1, AK2, AK3</td> <td></td> </tr> <tr> <td>BF250D, A</td> <td></td> </tr> </tbody> </table>  | REF | OEM | BF40D | | BF135A4, AK2 | | BF50D | | BF150A4, AK2 | | BF175D, AK1, AK2, AK3 | | BF200D, AK1, AK2, AK3 | | BF250D, A | | |
| REF | OEM | | | | | | | | | | | | | | | | | | | | | | | | | | | | | | | | | | | | | | | | |
| REC37830-RNA-A01 | 37830-RNA-A01 | | | | | | | | | | | | | | | | | | | | | | | | | | | | | | | | | | | | | | | | |
| REF | OEM | | | | | | | | | | | | | | | | | | | | | | | | | | | | | | | | | | | | | | | | |
|  BF100A, AK1 | | | | | | | | | | | | | | | | | | | | | | | | | | | | | | | | | | | | | | | | | |
|  BFT100AK1 | | | | | | | | | | | | | | | | | | | | | | | | | | | | | | | | | | | | | | | | | |
|  BF40E | | | | | | | | | | | | | | | | | | | | | | | | | | | | | | | | | | | | | | | | | |
|  BF80A, AK1 | | | | | | | | | | | | | | | | | | | | | | | | | | | | | | | | | | | | | | | | | |
|  BF75DK3, DK4 | | | | | | | | | | | | | | | | | | | | | | | | | | | | | | | | | | | | | | | | | |
|  BF90DK4, DK5 | | | | | | | | | | | | | | | | | | | | | | | | | | | | | | | | | | | | | | | | | |
|  BF60A | | | | | | | | | | | | | | | | | | | | | | | | | | | | | | | | | | | | | | | | | |
|  BF115D, DK1 | | | | | | | | | | | | | | | | | | | | | | | | | | | | | | | | | | | | | | | | | |
| REF | OEM | | | | | | | | | | | | | | | | | | | | | | | | | | | | | | | | | | | | | | | | |
| BF40D | | | | | | | | | | | | | | | | | | | | | | | | | | | | | | | | | | | | | | | | | |
| BF135A4, AK2 | | | | | | | | | | | | | | | | | | | | | | | | | | | | | | | | | | | | | | | | | |
| BF50D | | | | | | | | | | | | | | | | | | | | | | | | | | | | | | | | | | | | | | | | | |
| BF150A4, AK2 | | | | | | | | | | | | | | | | | | | | | | | | | | | | | | | | | | | | | | | | | |
| BF175D, AK1, AK2, AK3 | | | | | | | | | | | | | | | | | | | | | | | | | | | | | | | | | | | | | | | | | |
| BF200D, AK1, AK2, AK3 | | | | | | | | | | | | | | | | | | | | | | | | | | | | | | | | | | | | | | | | | |
| BF250D, A | | | | | | | | | | | | | | | | | | | | | | | | | | | | | | | | | | | | | | | | | |
| SENSOR POSICIÓN ÁRBOL DE LEVAS | CAMSHAFT SENSOR | SENSORE ALBERO A CAME | CAPTEUR DE POSITION D'ARBRE A CAMES | | | | | | | | | | | | | | | | | | | | | | | | | | | | | | | | | | | | | | |
| <table border="1"> <thead> <tr> <th>REF</th> <th>OEM</th> </tr> </thead> <tbody> <tr> <td>REC37510-PNB-003</td> <td>37510-PNB-003</td> </tr> <tr> <td> BF115D, DK1</td> <td></td> </tr> <tr> <td> BF135A4, AK2</td> <td></td> </tr> <tr> <td> BF150A4, AK2</td> <td></td> </tr> </tbody> </table>  | REF | OEM | REC37510-PNB-003 | 37510-PNB-003 |  BF115D, DK1 | |  BF135A4, AK2 | |  BF150A4, AK2 | | | <table border="1"> <thead> <tr> <th>REF</th> <th>OEM</th> </tr> </thead> <tbody> <tr> <td>REC37500-PNB-003</td> <td>37500-PNB-003</td> </tr> <tr> <td> BF175D</td> <td>BF90DK0, DK2, DK5</td> </tr> <tr> <td> BF200D</td> <td>BF75DK3, DK4</td> </tr> <tr> <td> BF225D</td> <td>BF100A, AK1</td> </tr> <tr> <td> BF250D</td> <td>BF80A, AK1</td> </tr> <tr> <td> BF115D, DK1</td> <td>BF60A</td> </tr> <tr> <td> BF135A4, AK2</td> <td>BF40E</td> </tr> <tr> <td> BF150A4, AK2</td> <td></td> </tr> <tr> <td> BF75DK0, DK2</td> <td></td> </tr> </tbody> </table>  | REF | OEM | REC37500-PNB-003 | 37500-PNB-003 |  BF175D | BF90DK0, DK2, DK5 |  BF200D | BF75DK3, DK4 |  BF225D | BF100A, AK1 |  BF250D | BF80A, AK1 |  BF115D, DK1 | BF60A |  BF135A4, AK2 | BF40E |  BF150A4, AK2 | |  BF75DK0, DK2 | | | | | | | | | | |
| REF | OEM | | | | | | | | | | | | | | | | | | | | | | | | | | | | | | | | | | | | | | | | |
| REC37510-PNB-003 | 37510-PNB-003 | | | | | | | | | | | | | | | | | | | | | | | | | | | | | | | | | | | | | | | | |
|  BF115D, DK1 | | | | | | | | | | | | | | | | | | | | | | | | | | | | | | | | | | | | | | | | | |
|  BF135A4, AK2 | | | | | | | | | | | | | | | | | | | | | | | | | | | | | | | | | | | | | | | | | |
|  BF150A4, AK2 | | | | | | | | | | | | | | | | | | | | | | | | | | | | | | | | | | | | | | | | | |
| REF | OEM | | | | | | | | | | | | | | | | | | | | | | | | | | | | | | | | | | | | | | | | |
| REC37500-PNB-003 | 37500-PNB-003 | | | | | | | | | | | | | | | | | | | | | | | | | | | | | | | | | | | | | | | | |
|  BF175D | BF90DK0, DK2, DK5 | | | | | | | | | | | | | | | | | | | | | | | | | | | | | | | | | | | | | | | | |
|  BF200D | BF75DK3, DK4 | | | | | | | | | | | | | | | | | | | | | | | | | | | | | | | | | | | | | | | | |
|  BF225D | BF100A, AK1 | | | | | | | | | | | | | | | | | | | | | | | | | | | | | | | | | | | | | | | | |
|  BF250D | BF80A, AK1 | | | | | | | | | | | | | | | | | | | | | | | | | | | | | | | | | | | | | | | | |
|  BF115D, DK1 | BF60A | | | | | | | | | | | | | | | | | | | | | | | | | | | | | | | | | | | | | | | | |
|  BF135A4, AK2 | BF40E | | | | | | | | | | | | | | | | | | | | | | | | | | | | | | | | | | | | | | | | |
|  BF150A4, AK2 | | | | | | | | | | | | | | | | | | | | | | | | | | | | | | | | | | | | | | | | | |
|  BF75DK0, DK2 | | | | | | | | | | | | | | | | | | | | | | | | | | | | | | | | | | | | | | | | | |
| SENSOR POSICIÓN CIGUENAL | CRANKSHAFT SENSOR | SENSORE ALBERO MOTORE | CAPTEUR DE POSITION DU VILEBREQUIN | | | | | | | | | | | | | | | | | | | | | | | | | | | | | | | | | | | | | | |
| <table border="1"> <thead> <tr> <th>REF</th> <th>OEM</th> </tr> </thead> <tbody> <tr> <td>REC37840-R70-A01</td> <td>37840-R70-A01</td> </tr> <tr> <td> BF175D</td> <td></td> </tr> <tr> <td> BF200D</td> <td></td> </tr> <tr> <td> BF225D</td> <td></td> </tr> <tr> <td> BF250D</td> <td></td> </tr> </tbody> </table>  | REF | OEM | REC37840-R70-A01 | 37840-R70-A01 |  BF175D | |  BF200D | |  BF225D | |  BF250D | | | | | | | | | | | | | | | | | | | | | | | | | | | | | | |
| REF | OEM | | | | | | | | | | | | | | | | | | | | | | | | | | | | | | | | | | | | | | | | |
| REC37840-R70-A01 | 37840-R70-A01 | | | | | | | | | | | | | | | | | | | | | | | | | | | | | | | | | | | | | | | | |
|  BF175D | | | | | | | | | | | | | | | | | | | | | | | | | | | | | | | | | | | | | | | | | |
|  BF200D | | | | | | | | | | | | | | | | | | | | | | | | | | | | | | | | | | | | | | | | | |
|  BF225D | | | | | | | | | | | | | | | | | | | | | | | | | | | | | | | | | | | | | | | | | |
|  BF250D | | | | | | | | | | | | | | | | | | | | | | | | | | | | | | | | | | | | | | | | | |
| SENSOR PRESIÓN DE ACEITE | OIL PRESSURE SENSOR | SENSORE PRESIONE DELL'OLIO | CAPTEUR DE PRESSION D'HUILE | | | | | | | | | | | | | | | | | | | | | | | | | | | | | | | | | | | | | | |
| <table border="1"> <thead> <tr> <th>REF</th> <th>OEM</th> </tr> </thead> <tbody> <tr> <td>REC37260-RNA-A01</td> <td>37260-RNA-A01</td> </tr> <tr> <td> BF175D</td> <td>BF150AK2</td> </tr> <tr> <td> BF200D</td> <td>BF75DK3, DK4</td> </tr> <tr> <td> BF225D</td> <td>BF90DK4, DK5</td> </tr> <tr> <td> BF250D</td> <td>BF100A, AK1</td> </tr> <tr> <td> BF115D, DK1,</td> <td>BF80A, AK1</td> </tr> <tr> <td> BF135A4, AK2</td> <td>BFT100AK1</td> </tr> </tbody> </table>  | REF | OEM | REC37260-RNA-A01 | 37260-RNA-A01 |  BF175D | BF150AK2 |  BF200D | BF75DK3, DK4 |  BF225D | BF90DK4, DK5 |  BF250D | BF100A, AK1 |  BF115D, DK1, | BF80A, AK1 |  BF135A4, AK2 | BFT100AK1 | | | | | | | | | | | | | | | | | | | | | | | | | |
| REF | OEM | | | | | | | | | | | | | | | | | | | | | | | | | | | | | | | | | | | | | | | | |
| REC37260-RNA-A01 | 37260-RNA-A01 | | | | | | | | | | | | | | | | | | | | | | | | | | | | | | | | | | | | | | | | |
|  BF175D | BF150AK2 | | | | | | | | | | | | | | | | | | | | | | | | | | | | | | | | | | | | | | | | |
|  BF200D | BF75DK3, DK4 | | | | | | | | | | | | | | | | | | | | | | | | | | | | | | | | | | | | | | | | |
|  BF225D | BF90DK4, DK5 | | | | | | | | | | | | | | | | | | | | | | | | | | | | | | | | | | | | | | | | |
|  BF250D | BF100A, AK1 | | | | | | | | | | | | | | | | | | | | | | | | | | | | | | | | | | | | | | | | |
|  BF115D, DK1, | BF80A, AK1 | | | | | | | | | | | | | | | | | | | | | | | | | | | | | | | | | | | | | | | | |
|  BF135A4, AK2 | BFT100AK1 | | | | | | | | | | | | | | | | | | | | | | | | | | | | | | | | | | | | | | | | |

SENSOR DETONACIÓN

KNOCK SENSOR

SENSORE ANTIDETONAZIONE

CAPTEUR DE CLIQUETIS

| REF | OEM |
|------------------|---------------|
| REC30530-P8F-A01 | 30530-P8F-A01 |



new

- BF175A3, A6
- BF200A2, A3, A6
- BF225A2, A3, A6

| REF | OEM |
|------------------|---------------|
| REC30530-PNA-003 | 30530-PNA-003 |



new

- BF135A4
- BF150A4

| REF | OEM |
|------------------|---------------|
| REC30530-RNA-A01 | 30530-RNA-A01 |



new

- BF175AK1, AK2, AK3
- BF200AK1, AK2, AK3
- BF225AK1, AK2, AK3
- BF250A

SENSOR MAT TEMPERATURA DEL AIRE

SENSOR MAT, AIR TEMPERATURE

SENSORE MAT, TEMPERATURA ARIA

CAPTEUR MAT DE TEMPERATURE D'AIR

| REF | OEM |
|------------------|---------------|
| REC37880-PLC-004 | 37880-PLC-004 |



new

- BF115D, DK1
- BF135A4, AK2
- BF150A4, AK2
- BF75DK0, DK2, DK3, DK4
- BF90DK2
- BF80A, AK1
- BFT80AK1
- BF60A, AK1
- BFP60A,
- BF40D, E
- BF50D,
- BF40DK2
- BF50DK2

SENSOR OXÍGENO

O2 SENSOR

SENSORE OSSIGENO

CAPTEUR À OXYGENE

| REF | OEM |
|------------------|---------------|
| REC35668-ZY6-003 | 35668-ZY6-003 |



- BF115D, DK1
- BF135A4, AK2
- BF150A4, AK2,

| REF | OEM |
|------------------|---------------|
| REC35655-ZY3-013 | 35655-ZY3-013 |



- BF175A3, A6,
- BF200A2, A3, A6
- BF225A2, A3, A6,

| REF | OEM |
|------------------|---------------|
| REC35655-ZY9-003 | 35655-ZY9-003 |



- BF75DK0, DK2
- BF90DK0, DK2
- BF75DK0, DK2
- BF90DK0, DK2

| REF | OEM |
|------------------|---------------|
| REC35655-ZY3-C01 | 35655-ZY3-C01 |



new

- BF250A,
- BF175AK1, AK2, AK3
- BF200AK1, AK2, AK3
- BF225AK1, AK2, AK3,
- BF40D, DK2, DK4
- BF50D, DK2, DK4,

RELÉ

RELAY

RELE

RELAIS

| REF | OEM |
|------------------|------------------|
| REC38580-ZY6-013 | 38580-ZY6-013/03 |

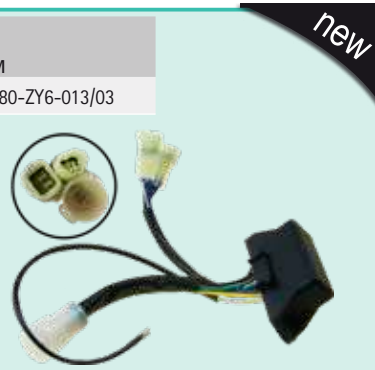

new

- BF135A4
- BF150A4

| REF | OEM |
|-----------------|--|
| REC8580-ZY9-023 | 38580-ZY9-003/013/023 HZY-38580-003 |



new

- BF75DK0, FK2, DK3, DK4
- BF90DK0, DK2, DK4, DK5
- BF100A, AK1
- BF80A, AK1

BOBINAS

COILS

BOBINE

BOBINES

| REF | OEM |
|------------------|---------------|
| REC30520-PWC-003 | 30520-PWC-S01 |



 BF75DK0, DK2, DK3
 BF90DK0, DK2, DK4
 BF100A
 BF80A

| REF | OEM |
|------------------|---------------|
| REC30520-PNA-007 | 30520-PNA-007 |





 VTEC
 BF135A4
 BF150A4
 BF115D, DK1
 BF135A4, BF150A4,
 BF135AK2, BF150AK2

| REF | OEM |
|------------------|---------------|
| REC30580-ZV4-013 | 30580-ZV4-023 |



 BF15AH, AK, AM, B, A1, A2, AX, AY,
 B2, BX, A3
 BF9.9AH, AK, AM, B, AX, AY
 BF8C, CX

| REF | OEM |
|------------------|---------------|
| REC30520-ZVL-003 | 30520-ZYL-003 |





 B175D
 BF200D
 BF225D
 BF250D

new

| REF | OEM |
|------------------|---------------------------------|
| REC30520-ZX2-003 | 30520-ZX2-003 HZX2-30520-003 |





 B175AK3
 BF200AK3
 BF225AK3
 BF250A

new

| REF | OEM |
|------------------|--------------|
| REC30520-ZY3-003 | 30520-Z3-003 |



 B175A3, A6, AK1, AK2
 BF200A2, A3, A6, AK1, AK2
 BF225A2, A3, A6, AK1

new

BUJÍAS

SPARK

CANDELE

BOUGIES

| | | REF NGK | | | REF NGK |
|-----------|---------|------------|-----------|---------|---------------|
| BF2D | 1999 | NGKCR5HSB | BF25D4 | 2004 | NGKDR7EA |
| BF2/A | 1984 | NGKBMR4A | BF28 | | NGKCR5HSB |
| BF2B | | NGKCR5HSB | BF28D | | NGKCR5HSB |
| BF2.3 | | NGKCR5HSB | BF30/A | 1994 | NGKDR7EA |
| BF4.5B | | NGKBPR5ES | BF30D4 | 2004 | NGKDR7EA |
| BF5AK | | NGKBPR5ES | BF35/A | 1990 | NGKDR7EA |
| BF5 | 1984 | NGKBPR5ES | BF40B | | NGKDR7EA |
| BF5A | | NGKBPR5ES | BF40/A | 1994 | NGKDR7EA |
| BF6B | 2003 | NGKDR4HS | BF45/A | 1990 | NGKDR7EA |
| BF6 | | NGKDR4HS | BF50/F | 1985-94 | NGKBPR5ES |
| BF6CH | 2004 | NGKCR5EH-9 | BF50 | 1986-94 | NGKBPR5ES |
| BF7,5 | 1977 | NGKDR5HS | BF50/A | 1994 | NGKDR7EA |
| BF8 | 2001 | NGKCR5EH-9 | BF60A | | NGKLMAR6C-9 |
| BF8D | | NGKCR5EH-9 | BF70A | | NGKDR7EA |
| BF8D1 | 2001 | NGKCR5EH-9 | BF75 | 2003 | NGKDR7EA |
| BF8 | 1987-00 | NGKDR5HS | BF75B | | NGKDR7EA |
| BF8 A/B/C | 1990-00 | NGKDR5HS | BF75D | | NGKIZFR6K-11E |
| BF8B1 | | NGKCR5EH-9 | BF75E | | NGKDR5HS |
| BF9/A | | NGKDR5HS | BF75A | 1995 | NGKDR7EA |
| BF9.9 | 1987-01 | NGKDR5HS | BF75 | | NGKDR5HS |
| BF9.9 A/B | | NGKDR5HS | BF90/A | 1995 | NGKDR7EA |
| BF9.9D1 | 2001 | NGKCR5EH-9 | BF90D | | NGKIZFR6K-11E |
| BF10D | 2001 | NGKCR5EH-9 | BF100E | | NGKDR5HS |
| BF10/B1 | 2001 | NGKCR5EH-9 | BF100 | | NGKDR5HS |
| BF15D | 2003 | NGKCR5EH-9 | BF115/A | 1998 | NGKZFR7F |
| BF15B | | NGKDR5HS | BF130A | 1998 | NGKZFR7F |
| BF15 | 1987-90 | NGKDR6HS | BF135A | | NGKIZFR6K11 |
| BF15A | 1996-02 | NGKDR5HS | BF150A | | NGKIZFR6K11 |
| BF20 | 1993 | NGKDR7EA | BF175A | | NGKIZFR6K11 |
| BF20/F | 1985 | NGKBMR4A | BF200A V6 | 2002 | NGKIZFR6K11 |
| BF20D | 2003 | NGKCR5EH-9 | BF225A V6 | 2002 | NGKIZFR6K11 |
| BF25/A | 1993 | NGKDR7EA | BF250A | 2010 | NGKIZFR6K11 |
| BF25B | | NGKDR7EA | | | |



| | | REF CHAMPION |
|-------|-------------------|--------------|
| 2HP | BF2A,D | CHACJ14 |
| 5HP | OHC - BF5A | CHARN11YC4 |
| 7.5HP | B75 | CHAP10Y |
| 8.0HP | OHC - BF8A | CHAP10Y |
| 9.9HP | BF9.9A | CHAP10Y |
| 15HP | OHC - BF15A | CHAP8Y |
| 20HP | BF20A | CHARA6HC |
| 25HP | OHC - BF25A | CHARA8HC |
| 30HP | OHC - BF30A | CHARA8HC |
| 35HP | BF35A | CHARA8HC |
| 40HP | OHC - BF40A | CHARA8HC |
| 45HP | BF45A | CHARA8HC |
| 50HP | OHC - BF50A | CHARA8HC |
| 70HP | OHC - BF70A | CHARA8HC |
| 75HP | BF75A | CHARA8HC |
| 90HP | OHC - BF90A | CHARA8HC |
| 115HP | OHC | CHARC9MC4 |
| 130HP | OHC | CHARC9MC4 |
| 150HP | BF150, BF200, 225 | CHARC9MC4 |



MOTORES DE ARRANQUE



STARTERS

MOTORINI AVVIAMENTO

DEMARREURS

MOTORES DE ARRANQUE

STARTERS



| REF | OEM |  |  |
|------------------|--------------------------------|---|---|
| REC31200-ZW9-802 | 31200-ZW9-802 31200-ZW9-801 | 12V | 11 CCW |

- BF8B2, D2, D3, D4
- BFP8B2, D2, D3, DK2
- BF9,9DK2, D3
- BF10D4, DK2, OB2,
- BFP10B2, D2,
- BFP9,9D3,





MOTORINI AVVIAMENTO

DEMARREURS

| REF | OEM |  |  |
|------------------|---|---|---|
| REC31200-ZY6-003 | 31200-ZY6-003 31200-ZY9-003 31200-ZY9A-0031 | 12V 1.00 KW | 9 CW |

- BF115D, DK1
- BF135A4, AK2
- BF150A4, AK2
- BF75DK0, DK2
- BF90DK2, DK0



| REF | OEM |  |  |
|------------|---------------|---|---|
| PH130-0064 | 31200-ZW1-004 | 12V 1.4 KW | 13 CW |



- BF75A1, A2, A3, AT, AV, AX,
- BF90A1, A2, A3, AT, 90AV, AX



| REF | OEM |  |  |
|------------|---------------|---|---|
| PH130-0065 | 31200-ZW5-003 | 12V 1.4 KW | 13 CW |



- BF115A1, A2, A3, AX,
- BF130A1, A2, A3, AX,



| REF | OEM |  |  |
|------------|--------------------------------|---|---|
| PH130-0054 | 31200-ZV5-013 31200-ZV5-003 | 12V 0.9 KW | 9 CW |

- BF35AM,
- BF40B, BX, AX, A1, A2, A3, A4, A'
- BF45AM, A, A1,
- BF50A, A1, A2, A3, A4, AX, AY,



| REF | OEM |  |  |
|------------|----------------------------------|---|---|
| PH130-0070 | 31200-ZY3-003 31200-ZY3A-0034 | 12V 1.7 KW | 9 CW |

- BF175D, A3, A6, AK1, AK2, AK3
- BF200D, A2, A3, A6, AK1, AK2, AK3
- BF225D, A2, A3, A6
- BF250D, A, AK1, AK2, AK3



GUÍA DE ARRANQUE

STARTER GUIDE

GUIDE AVVIAMENTO

GUIDE DE DÉMARREURS



| | | |
|-------|-----------|------------------|
| BF8 | 2001 | REC31200-ZW9-802 |
| BF10 | 2001 | REC31200-ZW9-802 |
| BF9,9 | 2001 | REC31200-ZW9-802 |
| BF35 | 1995-1997 | PH130-0054 |
| BF40 | 1995 | PH130-0054 |
| BF45 | 1995-1997 | PH130-0054 |
| BF50 | 1995 | PH130-0054 |
| BF75 | 2007 | REC31200-ZY6-003 |
| BF75 | 1997-2006 | PH130-0064 |
| BF90 | 1997-2006 | PH130-0064 |



| | | | |
|-------|-----------|------------------|------------------|
| BF90 | 2007 | REC31200-ZY6-003 | |
| BF115 | 1999-2006 | PH130-0065 | REC31630-ZW5-003 |
| BF115 | 2007 | REC31200-ZY6-003 | REC31630-ZY6-003 |
| BF130 | 1999-04 | PH130-0065 | REC31630-ZW5-003 |
| BF135 | 2004 | REC31200-ZY6-003 | REC31630-ZY6-003 |
| BF150 | 2004 | REC31200-ZY6-003 | REC31630-ZY6-003 |
| BF175 | 2002 | PH130-0070 | REC31630-ZY3-003 |
| BF200 | 2002 | PH130-0070 | REC31630-ZY3-003 |
| BF225 | 2002 | PH130-0070 | REC31630-ZY3-003 |
| BF250 | 2012 | PH130-0070 | REC31630-ZY3-003 |

DESCONECTORES DE SEGURIDAD

CUT OFF SWITCHES

CHIAVETTA DI SICUREZZA

COUPE CIRCUIT DE SECURITE

DESCONECTADOR DE SEGURIDAD

Interruptor de encendido para motores. Aísla los circuitos en unidades dobles para prevenir el retorno al alternador.

IGNITION KILL SWITCHES

Emergency and stop switch. Isolates circuits on dual units to prevent feedback.

INTERRUTTORE DI STOP

Interruttore di accensione per motori. Isola i circuiti in doppie unità per prevenire il ritorno all'alternatore.

COUPE CIRCUIT DE SECURITE

Interrupteur d'arrêt d'urgence. Il isole les circuits en double pour éviter le retour à l'alternateur.

| REF | | | | | |
|---------|-----------------|-----------------|-----------------|--------------------|---|
| THKS-1 | Un fueraborda | Single outboard | Un fuoribordo | Un hors-bord | 1 |
| THKS-2 | Un intraborda | Single I/O | Un entrobordeo | Un inboard | 1 |
| THKS-12 | Dos fuerabordos | Dual outboard | Due fuoribordo | Deux hors-bord | 1 |
| THKS-22 | Dos intrabordos | Dual I/O | Due entrobordeo | Deux inboard | 1 |
| THL-4 | Cuerda recambio | Spare lanyard | Corde ricambio | Cordon de rechange | 1 |



KITS

Interruptor de encendido para todo tipo de motores fueraborda o intraborda

KITS

Emergency and stop switch for inboard or outboards.

KIT

Interruttore di accensione per tutti i tipi di motori fuoribordo o entrobordeo.

KITS

Coupe circuit de sécurité pour moteur inboard ou hors-bord

| REF KIT | CUERDA WIRE CORDA CORDON | |
|----------|--------------------------|---|
| REC40970 | REC40990 | 1 |



| REF KIT | CUERDA WIRE CORDA CORDON | |
|---------|--------------------------|---|
| GS11290 | GS11291 | 1 |



| REF KIT | |
|---------|---|
| GS11292 | 1 |



| REF | |
|---------|---|
| GS11294 | 1 |



| REF | OEM |
|------------------|--|
| REC36180-ZV5-033 | 36180-ZV5-033 36180-ZV5-023 36180-ZV5-013 36180-ZV5-003 |

BF8-->BF250

ALTERNADOR

ALTERNATOR

ALTERNATORE

ALTERNATEUR

ALTERNADOR

ALTERNATOR

ALTERNATORE

ALTERNATEUR

| REF | OEM | | |
|------------------|--------------------------------|------------|--------------------|
| REC31630-ZY6-003 | 31630-ZY6-003 31630-ZY6-013 | 12V 55A | REC31638-ZY6-003 4 |

BF115D, DK1, BF135A4, AK2, BF150A4, AK2

| REF | OEM | | |
|------------------|---------------|------------------|---|
| REC31630-ZY3-003 | 31630-ZY3-003 | REC31638-ZY3-003 | 6 |

BF250A, BF175A3, A6, AK1, AK2, AK3, D, BF200A2, A3, A6, AK1, AK2, AK3, D, BF225A2, A3, A6, AK1, AK2, AK3, D, BF250D, A,

| REF | OEM | ⚡ | ⚙️ |
|------------------|---------------|---------------|----|
| REC31630-ZW5-003 | 31630-ZW5-003 | 12V 55A CW | 4 |

new



 BF115A1, A2, A3, AX
 BF130A1, A2, A3, A4, AX



CORREAS DE ALTERNADOR **ALTERNATOR BELT** **CURROIA ALTERNATORE** **COURROIE D'ALTERNATEUR**

| REF | OEM |
|------------------|---------------|
| REC31638-ZY3-003 | 31638-ZY3-003 |

new



 BF175A3, A6, AK1, AK2, AK3, D,
 BF200A2, A3, A6, AK1, AK2, AK3, D,
 BF225A2, A3, A6, AK1, AK2, AK3, D,
 BF250D



| REF | OEM |
|------------------|---------------|
| REC31638-ZY6-003 | 31638-ZY6-003 |

new

 F115D,
 BF115D, DK1,
 BF135A4, AK2
 BF150A4, AK2



TRIM, TILT & POWER TRIM

INSTALACIÓN ELÉCTRICA **WIRING HARNESS** **INSTALLAZIONE ELETTRICA** **INSTALLATION ELECTRIQUE**

KIT CONVERSIÓN **CONVERSION KIT** **KIT CONVERSIONE** **KIT DE CONVERSION.**
 Sustituye de 2 a 3 cables. Converte 3-wire Tilt and Trim motors to 2-Wire design Sostituisce da 2 a 3 cavi. Passe un faisceau de 2 à 3 fils

| REF |
|------------|
| PH200-WH01 |



TRIM COMPLETO **COMPLETE TRIM ASSEMBLY** **MOTORINO TRIM COMPLETO** **MOTEUR DE TRIM**

| REF | OEM | ⚡ | ⚙️ | ✂️ |
|------------|---------------|-----|----|----|
| PH200-T046 | 36120-ZV5-822 | 12V | 4 | 2 |

 BF40, BF50 (2002-03)



| REF | OEM | ⚡ | ⚙️ | ✂️ |
|------------|---------------|-----|----|----|
| PH200-T021 | 36120-ZV5-821 | 12V | 4 | 2 |

 BF35AM
 BF40B, B2, BX, A, A1, A2, AX, AY
 BF45AM
 BF50A, A1, A2, AX, AY





| REF | OEM | ⚡ | 🔩 | 🔧 |
|------------------|---------------|-----|---|---|
| REC36120-ZY3-013 | 36120-ZY3-013 | 12V | 4 | |

 BF175A3, A6, AK1, AK2
 BF200A2, A3, A6, AK2
 BF225A2, A3, A6, AK1, AK2,





| REF | OEM | ⚡ | 🔩 | 🔧 |
|------------------|---------------|-----|---|---|
| REC36120-ZW4-H12 | 36120-ZW4-H12 | 12V | 4 | |

 BF40A4,
 BF50A4,
 BF40D, DK2, DK4
 BF50D, DK2, DK4





| REF | OEM | ⚡ | 🔩 | 🔧 |
|------------------|--------------------------------|-----|---|---|
| REC36120-ZY6-013 | 36120-ZY6-013 36120-ZY6-023 | 12V | 4 | |

 BF115D, DK1
 BF135A4, AK2
 BF150A4, AK2



| REF | OEM | ⚡ | 🔩 | 🔧 |
|------------------|--------------------------------|-----|---|---|
| REC36120-ZY9-003 | 36120-ZY9-003 36120-ZY9-013 | 12V | 4 | |

 BF75DK0, DK2, DK3
 BF90DK0, DK2, DK4
 BF100A
 BF80A



POWER TRIM COMPLETO **COMPLETE POWER TRIM ASSEMBLY** **MOTORINO POWER TRIM COMPLETO** **POWER TRIM COMPLET**

| REF |
|------------|
| REC18-6865 |



 3 RAM
 115-225HP
 BF115+
 SHOWA SYSTEM



RELÉ DE POWER TRIM **POWER TRIM RELAY** **RELE POWER TRIM** **RELAIS POWER TRIM**

| REF | OEM |
|------------------|---------------------------------|
| REC38550-ZY6-003 | 38550-ZY6-003 HZY-638550-003 |

 BF115D, DK1
 BF135A4, AK2
 BF150A4, AK2



| REF | OEM |
|------------------|---------------|
| REC38550-ZV5-823 | 38550-ZV5-823 |

 BF40B2,A4,A2,A3
 BF50A4,A2



EXTRACTOR TAPONES TRIM **TRIM PLUGS EXTRACTOR** **ESTRATTORE PER TAPPI DI TRIM** **KIT EXTRACTEUR DE BOUCHONS TRIM**

| REF | RECTOOLTRIMKIT |
|-----|--|
| | RECTOOLTRIM1 + RECTOOLTRIM2 + RECTOOLTRIM3 |



| REF | 🔧 | A |
|--------------|----------------------------|-------|
| RECTOOLTRIM1 | 1/2" + RECPIN4 + RECPIN4.5 | 38 mm |
| RECTOOLTRIM2 | 1/2" + RECPIN4 + RECPIN4.5 | 32 mm |
| RECTOOLTRIM3 | 1/2" + RECPIN6 | 35 mm |



| TRIM PISTON | TILT PISTON | 🔧 |
|--------------|--------------|--------------------|
| RECTOOLTRIM2 | RECTOOLTRIM3 | 75 --> 225 (1997+) |

REF

| | |
|-----------|----------------|
| RECPIN4 | 3 PIN x 4 mm |
| RECPIN4.5 | 3 PIN x 4.5 mm |
| RECPIN6 | 3 PIN x 6 mm |



Los pines de repuesto no tienen garantía.
 Replacement pins are not guaranteed.
 I pèrni di ricambio non sono garantiti.
 Les pins de remplacement ne sont pas garanties

SISTEMA DE GOBIERNO STEERING SYSTEM

SISTEMA DI GUIDA SYSTÈME DE COMMANDE

MANDOS DE CONTROL

ENGINE CONTROLS

COMANDI DI CONTROLLO

BOITIER DE COMMANDE

MANDO LATERAL

SIDE CONTROL

COMANDO LATERALE

BOITIER LATERAL

| REF | OEM | POWER TRIM |
|------------------|---|------------|
| REC24800-ZZ5-A02 | 24800-ZZ5-A02 24800-ZZ5-A01 24800-ZZ5-A22 | ✓ |

RECMAR

(NHK MEC) BF40 --> BF250
EFI
4 LED



MANDO PARA CONSOLA

CONSOLE CONTROL

COMANDO PER CONSOLLA

BOITIER POUR CONSOLE

| REF | RO OEM | TRIM TILT |
|------------------|---------------------------------|-----------|
| REC06240-ZW5-U40 | 06240-ZW5-U40 06240-ZW5-U001 | ✓ |

| REF | RO OEM | TRIM TILT |
|------------------|---------------|-----------|
| REC06240-ZW5-U60 | 06240-ZW5-U60 | ✓ |

BF40 --> BF250

RECMAR



**INTERRUPTOR DE TRIM
MANDOS LATERALES**

**TRIM SWITCH
SIDE CONTROLS**

**INTERRUTTORE TRIM
COMANDO LATERALE**

**INTERRUPTEUR TRIM
BOITIER LATERAL**

| REF | OEM |
|------------------|---------------|
| REC35370-ZZ5-D02 | 35370-ZZ5-D02 |

DF8 --> DF250

new

| REF | OEM |
|------------------|---------------|
| REC35340-ZZ5-D21 | 35340-ZZ5-D21 |

DF40-->DF250
(2007+)

new

**INTERRUPTOR DE TRIM
MANDOS CONSOLA**

**TRIM SWITCH
CONTROLS**

**INTERRUTTORE TRIM
PANELLO**

**INTERRUPTEUR TRIM
CONSOLE**

| REF | OEM |
|------------------|---------------|
| REC35370-ZW5-U02 | 35370-ZW5-U02 |

A

new

| REF | OEM |
|------------------|---------------|
| REC35370-ZW5-U12 | 35370-ZW5-U12 |

B

BF25 --> BF250

new

**LLAVES ARRANQUE
IGNITION STARTER
SWITCH**

**CHIAVI DI
ACCENSIONE**

CONTACTEUR A CLÉ

| REF | OEM |
|------------------|---------------|
| REC35100-ZV5-013 | 35100-ZV5-013 |

BF8 --> BF250

new

**CABLES DE
CONTROL**

CONTROL CABLES

CAVI COMANDO

**CÂBLES DE
COMMANDE**

Recorrido trabajo: 76 mm.
Rosca 10-32"

Travel 3"
Threaded 10-32"

Estensione 76 mm
Filetto 10-32"

Course: 76 mm.
Fil 10-32

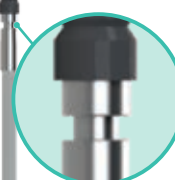
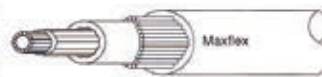

maxflex



| REF | RO | |
|------------|---------------|--------------|
| PRE3300C05 | 24911-ZW7-U01 | 5' / 1,52 m |
| PRE3300C06 | 24912-ZW7-U01 | 6' / 1,83 m |
| PRE3300C07 | 24913-ZW7-U01 | 7' / 2,13 m |
| PRE3300C08 | 24914-ZW7-U01 | 8' / 2,45 m |
| PRE3300C09 | 24915-ZW7-U01 | 9' / 2,75 m |
| PRE3300C10 | 24916-ZW7-U01 | 10' / 3,05 m |
| PRE3300C11 | 24917-ZW7-U01 | 11' / 3,35 m |
| PRE3300C12 | 24918-ZW7-U01 | 12' / 3,65 m |
| PRE3300C13 | 24919-ZW7-U01 | 13' / 3,95 m |
| PRE3300C14 | 24920-ZW7-U01 | 14' / 4,25 m |
| PRE3300C15 | 24921-ZW7-U01 | 15' / 4,60 m |
| PRE3300C16 | 24922-ZW7-U01 | 16' / 4,90 m |
| PRE3300C17 | 24923-ZW7-U01 | 17' / 5,20 m |
| PRE3300C18 | 24924-ZW7-U01 | 18' / 5,50 m |

| REF | RO | |
|------------|---------------|--------------|
| PRE3300C19 | 24925-ZW7-U01 | 19' / 5,80 m |
| PRE3300C20 | 24926-ZW7-U01 | 20' / 6,10 m |
| PRE3300C21 | 24927-ZW7-U01 | 21' / 6,40 m |
| PRE3300C22 | 24928-ZW7-U01 | 22' / 6,70 m |
| PRE3300C23 | 24929-ZW7-U01 | 23' / 7,00 m |
| PRE3300C24 | 24930-ZW7-U01 | 24' / 7,30 m |
| PRE3300C25 | 24931-ZW7-U01 | 25' / 7,60 m |
| PRE3300C26 | 24932-ZW7-U01 | 26' / 7,90 m |
| PRE3300C27 | 24933-ZW7-U01 | 27' / 8,25 m |
| PRE3300C28 | 24934-ZW7-U01 | 28' / 8,55 m |
| PRE3300C29 | 24935-ZW7-U01 | 29' / 8,85 m |
| PRE3300C30 | 24936-ZW7-U01 | 30' / 9,15 m |
| PRE3300C31 | 24937-ZW7-U01 | 31' / 9,45 m |
| PRE3300C32 | 24938-ZW7-U01 | 32' / 9,75 m |

SISTEMA DE REFRIGERACIÓN COOLING SYSTEM

SISTEMA DI RAFFREDDAMENTO SYSTEME DE REFROIDISSEMENT

TERMOSTATO

THERMOSTAT

TERMOSTATO

THERMOSTAT

TERMOSTATOS

THERMOSTATS

TERMOSTATO

THERMOSTATS

| REF | OEM | °C |
|------------------|---------------|------|
| REC19300-881-761 | 19300-881-761 | 52°C |

- BF4.5B, BX, BK2, B2, B4, B6, BKO
- BF5AH, AK, AM, AX, AK2, A2, A3, A4
- BF15AH, AK, AM, B, A1, A2, A3, AX, AY, B2, BX
- F6B, BX
- BF8AX, B, BX, C, CX, AH, AK, AM
- BF100F
- BF75F
- BF9.9AH, AK, AM, B, AX, BX, AY



| REF | OEM | °C |
|----------------|---|------|
| PAF15-07000031 | 19300-ZW9-003 19300-881-741 19300-921-003 | 60°C |

- BF25D4, DK2
- BF30D4, DK2
- BF40A, D, DK2, E
- BF50A, D, DK2
- BF8B1, B2, D1, D2, DK2, D3, D4
- BF9.9DK2, D1, D2, D3
- BF10B1, B1, D4, DK2, B2, D2
- BF15D3, DK2
- BF20D3
- BF200A
- BF225A
- BF75DK0, DK2, DK3
- BF90DK0, DK2, DK4
- BF100A
- BF80A
- BF60A, AK1



| REF | OEM | °C |
|-----------------|---------------|------|
| REC67F-12411-01 | 19300-ZX2-003 | 60°C |

- BF175D,
- BF200D,
- BF225D,
- BF250A, D



| REF | OEM | °C |
|------------------|---|------|
| REC19300-ZV5-043 | 19300-ZV5-003, 19300-ZV5-013, 19300-ZV5-023, 19300-ZV5-033, 19300-ZV5-043 | 72°C |

- BF35AM
- BF40B, B2, BX, AX, A1, A2,
- A3, AY
- BF45AM
- BF20AX, A
- BF25A, A1, AX
- BF30A, A1, AX, A2, A3
- BF75A1, AT, AV, AX, A2, A3
- BF90A1, AT, AV, AX, A2, A3
- BF115A1, A2, AX
- BF130A1, A2, AX
- BF50A2, AX, A1, A3, AY
- BF20A2, A3
- BF25A1, A2, A3



| REF | OEM | °C |
|-----------------|---------------|------|
| REC6E5-12411-30 | 19300-ZY6-003 | 50°C |

- BF75DK0, DK2, DK3, DK4
- BF80A, AK1
- BF90DK0, DK2, DK4, DK5
- BF100A, AK1
- BF115D, DK1
- BF135A4, AK2
- BF150A4, AK2
- BF780AK1
- BFT100AK1



| REF | OEM | °C |
|-----------------|---------------|------|
| REC6AH-12411-00 | 19300-ZY3-023 | 60°C |

- BF115A2, A3, D, DK1,
- BF130A2, A3,
- BF135A4, AK2,
- BF150A4, AK2,
- BF175A3, A6, AK1, AK2, AK3,
- BF200A2, A3, A6, AK1, AK2, AK3,
- BF225A2, A3, A6, AK1, AK2, K3,



GUÍA TERMOSTATO

THERMOSTAT GUIDE

GUIDA TERMOSTATO

GUIDE DES THERMOSTATS

| REF | REF |
|----------|------------------|
| B75K2 | PAF15-07000031 |
| B75K3 | PAF15-07000031 |
| BD115DK1 | REC6E5-12411-30 |
| BD130A2 | REC19300-ZV5-043 |
| BF100A | PAF15-07000031 |
| BF100A | PAF15-07000031 |
| BF100A | REC6E5-12411-30 |
| BF100AK1 | PAF15-07000031 |
| BF100AK1 | REC6E5-12411-30 |
| BF100B | PAF15-07000031 |
| BF100C | PAF15-07000031 |
| BF100D | PAF15-07000031 |
| BF100E | PAF15-07000031 |
| BF100F | PAF15-07000031 |
| BF100F | REC19300-881-761 |
| BF10B1 | PAF15-07000031 |
| BF10B2 | PAF15-07000031 |
| BF10D1 | PAF15-07000031 |

| REF | REF |
|----------|------------------|
| BF10D2 | PAF15-07000031 |
| BF10D4 | PAF15-07000031 |
| BF10DK2 | PAF15-07000031 |
| BF115A1 | REC19300-ZV5-043 |
| BF115A2 | REC19300-ZV5-043 |
| BF115A2 | REC6AH-12411-00 |
| BF115A3 | REC6AH-12411-00 |
| BF115D | REC6AH-12411-00 |
| BF115D | REC6E5-12411-30 |
| BF115DK1 | REC6AH-12411-00 |
| BF130A1 | REC19300-ZV5-043 |
| BF130A2 | REC6AH-12411-00 |
| BF130A3 | REC6AH-12411-00 |
| BF130AX | REC19300-ZV5-043 |
| BF135A4 | REC6AH-12411-00 |
| BF135A4 | REC6E5-12411-30 |
| BF135AK2 | REC6AH-12411-00 |
| BF135AK2 | REC6E5-12411-30 |

| REF | REF |
|----------|------------------|
| BF150A4 | REC6AH-12411-00 |
| BF150A4 | REC6E5-12411-30 |
| BF150AK2 | REC6AH-12411-00 |
| BF150AK2 | REC6E5-12411-30 |
| BF15A1 | REC19300-881-761 |
| BF15A2 | REC19300-881-761 |
| BF15A3 | REC19300-881-761 |
| BF15AH | REC19300-881-761 |
| BF15AK | REC19300-881-761 |
| BF15AM | REC19300-881-761 |
| BF15AX | REC19300-881-761 |
| BF15AY | REC19300-881-761 |
| BF15B2 | REC19300-881-761 |
| BF15BX | REC19300-881-761 |
| BF15D3 | PAF15-07000031 |
| BF15DK2 | PAF15-07000031 |
| BF15DK3 | PAF15-07000031 |
| BF175A3 | REC6AH-12411-00 |

| REF | REF |
|----------|------------------|
| BF175A6 | REC6AH-12411-00 |
| BF175AK1 | REC6AH-12411-00 |
| BF175AK2 | REC6AH-12411-00 |
| BF175AK3 | REC6AH-12411-00 |
| BF175D | REC67F-12411-01 |
| BF200A2 | PAF15-07000031 |
| BF200A2 | REC6AH-12411-00 |
| BF200A3 | REC6AH-12411-00 |
| BF200A6 | REC6AH-12411-00 |
| BF200AK1 | REC6AH-12411-00 |
| BF200AK2 | REC6AH-12411-00 |
| BF200AK3 | REC6AH-12411-00 |
| BF200D | REC67F-12411-01 |
| BF20A | REC19300-ZV5-043 |
| BF20A2 | REC19300-ZV5-043 |
| BF20AX | REC19300-ZV5-043 |
| BF20D3 | PAF15-07000031 |
| BF20DK2 | PAF15-07000031 |

| REF | REF |
|----------|------------------|
| BF20DK3 | PAF15-07000031 |
| BF225A2 | PAF15-07000031 |
| BF225A2 | REC6AH-12411-00 |
| BF225A3 | REC6AH-12411-00 |
| BF225A6 | REC6AH-12411-00 |
| BF225AK1 | REC6AH-12411-00 |
| BF225AK2 | REC6AH-12411-00 |
| BF225AK3 | REC6AH-12411-00 |
| BF225D | REC67F-12411-01 |
| BF250A | REC67F-12411-01 |
| BF250D | REC67F-12411-01 |
| BF25A | REC19300-ZV5-043 |
| BF25A1 | REC19300-ZV5-043 |
| BF25A2 | REC19300-ZV5-043 |
| BF25A3 | REC19300-ZV5-043 |
| BF25AX | REC19300-ZV5-043 |
| BF25D4 | PAF15-07000031 |
| BF25DK2 | PAF15-07000031 |
| BF30A | REC19300-ZV5-043 |
| BF30A1 | REC19300-ZV5-043 |
| BF30A2 | REC19300-ZV5-043 |
| BF30A3 | REC19300-ZV5-043 |
| BF30AX | REC19300-ZV5-043 |
| BF30D4 | PAF15-07000031 |
| BF30DK2 | PAF15-07000031 |
| BF35AM | REC19300-ZV5-043 |
| BF4,5B | REC19300-881-761 |
| BF4,5B2 | REC19300-881-761 |
| BF4,5B4 | REC19300-881-761 |
| BF4,5B6 | REC19300-881-761 |
| BF4,5BK0 | REC19300-881-761 |
| BF4,5BK2 | REC19300-881-761 |
| BF4,5BX | REC19300-881-761 |
| BF4,9DH | REC19300-881-761 |
| BF40A | REC19300-ZV5-043 |
| BF40A1 | REC19300-ZV5-043 |
| BF40A2 | REC19300-ZV5-043 |
| BF40A3 | REC19300-ZV5-043 |
| BF40A4 | PAF15-07000031 |
| BF40AX | REC19300-ZV5-043 |
| BF40AY | REC19300-ZV5-043 |

| REF | REF |
|---------|------------------|
| BF40B | REC19300-ZV5-043 |
| BF40B2 | REC19300-ZV5-043 |
| BF40BX | REC19300-ZV5-043 |
| BF40D | PAF15-07000031 |
| BF40DK2 | PAF15-07000031 |
| BF40DK4 | PAF15-07000031 |
| BF40E | PAF15-07000031 |
| BF45AM | REC19300-ZV5-043 |
| BF4AH | REC19300-881-761 |
| BF50A | REC19300-ZV5-043 |
| BF50A1 | REC19300-ZV5-043 |
| BF50A2 | REC19300-ZV5-043 |
| BF50A3 | REC19300-ZV5-043 |
| BF50A4 | PAF15-07000031 |
| BF50AX | REC19300-ZV5-043 |
| BF50AY | REC19300-ZV5-043 |
| BF50D | PAF15-07000031 |
| BF50DK2 | PAF15-07000031 |
| BF50DK4 | PAF15-07000031 |
| BF50F | REC19300-881-761 |
| BF5A1 | REC19300-881-761 |
| BF5A2 | REC19300-881-761 |
| BF5A3 | REC19300-881-761 |
| BF5A4 | REC19300-881-761 |
| BF5AH | REC19300-881-761 |
| BF5AK | REC19300-881-761 |
| BF5AK2 | REC19300-881-761 |
| BF5AM | REC19300-881-761 |
| BF5AX | REC19300-881-761 |
| BF5DH | REC19300-881-761 |
| BF60A | PAF15-07000031 |
| BF60AK1 | PAF15-07000031 |
| BF6AH | REC19300-881-761 |
| BF6B | REC19300-881-761 |
| BF6BX | REC19300-881-761 |
| BF6D6 | PAF15-07000031 |
| BF75A | PAF15-07000031 |
| BF75A1 | REC19300-ZV5-043 |
| BF75A2 | REC19300-ZV5-043 |
| BF75A3 | REC19300-ZV5-043 |
| BF75AT | REC19300-ZV5-043 |

| REF | REF |
|---------|------------------|
| BF75AV | REC19300-ZV5-043 |
| BF75AX | REC19300-ZV5-043 |
| BF75B | PAF15-07000031 |
| BF75C | PAF15-07000031 |
| BF75D | PAF15-07000031 |
| BF75D | PAF15-07000031 |
| BF75DK0 | REC6E5-12411-30 |
| BF75DK2 | PAF15-07000031 |
| BF75DK2 | REC6E5-12411-30 |
| BF75DK3 | PAF15-07000031 |
| BF75DK3 | REC6E5-12411-30 |
| BF75DK4 | PAF15-07000031 |
| BF75DK4 | REC6E5-12411-30 |
| BF75DK0 | PAF15-07000031 |
| BF75E | PAF15-07000031 |
| BF75F | PAF15-07000031 |
| BF75F | REC19300-881-761 |
| BF80A | PAF15-07000031 |
| BF80A | REC6E5-12411-30 |
| BF80AK1 | PAF15-07000031 |
| BF80AK1 | REC6E5-12411-30 |
| BF8AH | PAF15-07000031 |
| BF8AH | REC19300-881-761 |
| BF8AK | REC19300-881-761 |
| BF8AM | PAF15-07000031 |
| BF8AM | REC19300-881-761 |
| BF8AX | REC19300-881-761 |
| BF8B | REC19300-881-761 |
| BF8B1 | PAF15-07000031 |
| BF8B2 | PAF15-07000031 |
| BF8BX | REC19300-881-761 |
| BF8C | REC19300-881-761 |
| BF8CX | REC19300-881-761 |
| BF8D1 | PAF15-07000031 |
| BF8D2 | PAF15-07000031 |
| BF8D3 | PAF15-07000031 |
| BF8D4 | PAF15-07000031 |
| BF9,9AH | REC19300-881-761 |
| BF9,9AK | REC19300-881-761 |
| BF9,9AM | REC19300-881-761 |
| BF9,9AX | REC19300-881-761 |

| REF | REF |
|-----------|------------------|
| BF9,9AY | REC19300-881-761 |
| BF9,9B | REC19300-881-761 |
| BF9,9BX | REC19300-881-761 |
| BF9,9D1 | PAF15-07000031 |
| BF9,9D2 | PAF15-07000031 |
| BF9,9D3 | PAF15-07000031 |
| BF9,9DK2 | PAF15-07000031 |
| BF90A1 | REC19300-ZV5-043 |
| BF90A2 | REC19300-ZV5-043 |
| BF90A3 | REC19300-ZV5-043 |
| BF90AT | REC19300-ZV5-043 |
| BF90AV | REC19300-ZV5-043 |
| BF90AX | REC19300-ZV5-043 |
| BF90DK2 | PAF15-07000031 |
| BF90DK2 | REC6E5-12411-30 |
| BF90DK4 | PAF15-07000031 |
| BF90DK4 | REC6E5-12411-30 |
| BF90DK5 | PAF15-07000031 |
| BF90DK0 | PAF15-07000031 |
| BF90DK0 | REC6E5-12411-30 |
| BF990DK5 | REC6E5-12411-30 |
| BFDK2 | PAF15-07000031 |
| BFP10B1 | PAF15-07000031 |
| BFP10B2 | PAF15-07000031 |
| BFP10D1 | PAF15-07000031 |
| BFP10D2 | PAF15-07000031 |
| BFP60A | PAF15-07000031 |
| BFP60AK1 | PAF15-07000031 |
| BFP8B1 | PAF15-07000031 |
| BFP8B2 | PAF15-07000031 |
| BFP8D2 | PAF15-07000031 |
| BFP8D3 | PAF15-07000031 |
| BFP9,9D1 | PAF15-07000031 |
| BFP9,9D2 | PAF15-07000031 |
| BFP9,9D3 | PAF15-07000031 |
| BFPD1 | PAF15-07000031 |
| BFT100AK1 | PAF15-07000031 |
| BFT100AK1 | REC6E5-12411-30 |
| BFT80AK1 | PAF15-07000031 |
| BFT80AK1 | REC6E5-12411-30 |

IMPULSORES IMPELLERS GIRANTE TURBINES

IMPULSORES IMPELLER GIRANTE TURBINES







| REF | OEM |
|------------------|---------------|
| REC19210-ZV4-651 | 19210-ZV4-651 |



 BF8C, CX
 BF9,9AM, AX, B, BX
 BF15A1, A2, A3, AM, AX, AY, B, B2, BX



| REF | OEM |
|------------------|--------------------------------|
| REC19210-ZW9-013 | 19210-ZW9-013 19210-ZW9-003 |



 BF8B1, B2, D1, D2, D3, D4, DK2
 BF9,9D1, D2, D3, DK2
 BF10B1, B2, D1, D2, D4, DK2
 BFP8B1, B2, D1, D2, D3
 BFP9,9D1, D2, D3
 BFP10B1, B2, D1, D2

| REF | OEM |
|----------------|---------------|
| REC47-43026Q02 | 19210-ZW1-303 |



 BF75
 BF90AT

| REF | OEM |
|------------------|---------------|
| REC19210-ZV4-013 | 19210-ZV4-013 |



 BF9,9AH, AK, AM
 BF15AH, AK, AM



| REF | OEM |
|------------------|---------------|
| REC19210-ZY9-H01 | 19210-ZY9-H01 |



 F75DK3, DK4
 BF80A, AK1
 BF90DK4, DK5
 BF100A, AK1

| REF | OEM |
|------------------|---------------|
| REC19210-ZV7-003 | 19210-ZV7-003 |





 BF20A, A2, AX
 BF25A, A1, A2, A3, AX, D4, DK2
 BF30A, A1, A2, A3, AX, D4, DK2

HONDA

RECAMBIOS MARINOS

| REF | OEM |
|------------------|---|
| REC19210-881-003 | 19210-881-003 19210-881-A01 19210-881-A02 |



 BF4,5B, B2, B4, B6, BK0, BK2, BX
 BF5A1, A2, A3, A4, AH, AK, AK2, AX
 BF6B, BZ, D6
 BF8AH, AK, AM, AX, B, BX
 BF50F
 BF75A, B, C, D, E
 BF100A, B, C, D, E, F

| REF | OEM |
|------------------|---------------------------------|
| REC19210-ZW9-A32 | 19210-ZW9-A31, 19210-ZW9-A32 |



 BF8B1, B2, D1, D2, D3
 BF9,9DK2
 BF10D2, D4, DK2
 BF15D3, DK2, DK3
 BF20D3, DK2, DK3
 BFP8B1, B2, D1, D2, D3
 BFP9,9D, D1, D2
 BFP10B1, B2, D1, D2

| REF | OEM |
|------------------|---------------|
| REC19210-ZY3-003 | 19210-ZY3-003 |



 BF175A3, A6, AK1, AK2, AK3, D
 BF200A2, A3, A6, AK1, AK2, AK3, D
 BF225A, A2, A, A6, AK1, AK2, D
 BF250A, D

| REF | OEM |
|------------------|---------------|
| REC19210-ZV5-003 | 19210-ZV5-003 |



 BF35AM
 BF40A, A1, A2, A3, A4, AX, AY, B,
 B2, BX, D, DK2, DK4, E
 BF45AM
 BF50A, A1, A2, A3, AX, AY, D, DK2,
 DK4
 BF60A, AK1
 BFP60A, AK1

| REF | OEM |
|------------------|---|
| REC19210-ZW1-B02 | 19210-ZW1-B02 19210-ZW1-B03 19210-ZW1-B04 |









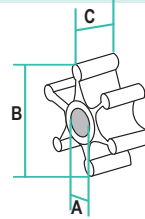



 BF75A1, A2, A3, AV, AX, DK0, DK2
 BF90A1, A2, A3, AV, AX, DK0, DK2
 BF115A1, A2, A3, AX, D, DK1
 BF130A1, A2, A3, AX
 BF135A4, AK2
 BF150A4











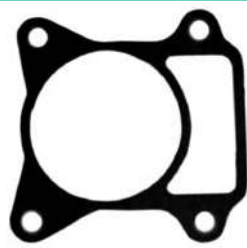

GUÍA DE IMPULSORES IMPELLER GUIDE GUIDA GIRANTE GUIDE DES TURBINES

|  | REF | CEF | A (mm) | B (mm) | C (mm) |
|---|--|------------------|-----------|--------|------------|
| | BF100A, AK1 | REC19210-ZY9-H01 | | | |
| | BF100A, B, C, D, E, F | REC19210-881-003 | | | |
| | BF10B1, B2, D1, D2, D4, DK2 | REC19210-ZW9-013 | CEF500347 | 13 | 45,6 14,8 |
| | BF10D2, D4, DK2 | REC19210-ZW9-A32 | CEF500348 | 16,2 | 45,6 14,8 |
| | BF115A1, A2, A3, AX | REC19210-ZW1-B02 | CEF500337 | 23,35 | 87,8 31 |
| | BF115D, DK1 | REC19210-ZW1-B02 | CEF500337 | 23,35 | 87,8 31 |
| | BF130A1, A2, A3, AX | REC19210-ZW1-B02 | CEF500337 | 23,35 | 87,8 31 |
| | BF135A4, AK2 | REC19210-ZW1-B02 | CEF500337 | 23,35 | 87,8 31 |
| | BF150A4 | REC19210-ZW1-B02 | CEF500337 | 23,35 | 87,8 31 |
| | BF15A1, A2, A3, AM, AX, AY, B, B2, BX | REC19210-ZV4-651 | CEF500343 | 14,1 | 41 27,55 |
| | BF15AH, AK, AM | REC19210-ZV4-013 | CEF500328 | 14,2 | 41 27,55 |
| | BF15D3, DK2, DK3 | REC19210-ZW9-A32 | CEF500348 | 16,2 | 45,6 14,8 |
| | BF175A3, A6, AK1, AK2, AK3, D | REC19210-ZY3-003 | CEF500391 | 26 | 89,75 31,3 |
| | BF200A2, A3, A6, AK1, AK2, AK3, D | REC19210-ZY3-003 | CEF500391 | 26 | 89,75 31,3 |
| | BF20A, A2, AX | REC19210-ZV7-003 | CEF500339 | 17,2 | 55,75 20,2 |
| | BF20D3, DK2, DK3 | REC19210-ZW9-A32 | CEF500348 | 16,2 | 45,6 14,8 |
| | BF20F | RM19211-ZV0-003 | | 10,5 | 40 22,5 |
| | BF225A, A2, A3, A6, AK1, AK2, D | REC19210-ZY3-003 | CEF500391 | 26 | 89,75 31,3 |
| | BF250A, D | REC19210-ZY3-003 | CEF500391 | 26 | 89,75 31,3 |
| | BF25A, A1, A2, A3, AX, D4, DK2 | REC19210-ZV7-003 | CEF500339 | 17,2 | 55,75 20,2 |
| | BF2AH, AK, AM | RM19211-ZV0-003 | | 10,5 | 40 22,5 |
| | BF30A, A1, A2, A3, AX, D4, DK2 | REC19210-ZV7-003 | CEF500339 | 17,2 | 55,75 20,2 |
| | BF35AM | REC19210-ZV5-003 | CEF500338 | 17,2 | 55,9 20,2 |
| | BF4,5B, B2, B3, B6, BK0, BK2, BX | REC19210-881-003 | | | |
| | BF40A, A1, A2, A3, A4, AX, AY, B, B2, BX, D, DK2, DK4, E | REC19210-ZV5-003 | CEF500338 | 17,2 | 55,9 20,2 |
| | BF45AM | REC19210-ZV5-003 | CEF500338 | 17,2 | 55,9 20,2 |
| | BF50A, A1, A2, A3, AX, AY, D, DK4 | REC19210-ZV5-003 | CEF500338 | 17,2 | 55,9 20,2 |
| | BF50F, A1, A2, A3, A4, AH, AK, AK2, AX | REC19210-881-003 | | | |
| | BF60A, AK1 | REC19210-ZV5-003 | CEF500338 | 17,2 | 55,9 20,2 |
| | BF6B, BZ, D6 | REC19210-881-003 | | | |
| | BF75 | REC47-43026Q02 | CEF500301 | 22,4 | 89 32,5 |
| | BF75A | REC19210-881-003 | | | |



|  | REF | CEF | A (mm) | B (mm) | C (mm) |
|---|--|------------------|-----------|--------|-----------|
| | BF75A1, A2, A3, AV, AX, DK0, DK2, DK3, DK4 | REC19210-ZW1-B02 | CEF500337 | 23,35 | 87,8 31 |
| | BF75B, C, D, E | REC19210-881-003 | | | |
| | BF80A, AK1 | REC19210-ZY9-H01 | | | |
| | BF8AH, AK, AM, AX, B | REC19210-881-003 | | | |
| | BF8B1, B2 | REC19210-ZW9-013 | CEF500347 | 13 | 45,6 14,8 |
| | BF8B1, B2 | REC19210-ZW9-A32 | CEF500348 | 16,2 | 45,6 14,8 |
| | BF8BX | REC19210-881-003 | | | |
| | BF8C, CX | REC19210-ZV4-651 | CEF500343 | 14,1 | 41 27,55 |
| | BF8D1, D2, D3, D4, DK2 | REC19210-ZW9-013 | CEF500347 | 13 | 45,6 14,8 |
| | BF8D1, D2, D3 | REC19210-ZW9-A32 | CEF500348 | 16,2 | 45,6 14,8 |
| | BF9,9AH, AK, AM | REC19210-ZV4-013 | CEF500328 | 14,2 | 41 27,55 |
| | BF9,9AM, AX, B, BX | REC19210-ZV4-651 | CEF500343 | 14,1 | 41 27,55 |
| | BF9,9D1, D2, D3, DK2 | REC19210-ZW9-013 | CEF500347 | 13 | 45,6 14,8 |
| | BF9,9DK2 | REC19210-ZW9-A32 | CEF500348 | 16,2 | 45,6 14,8 |
| | BF90A1, A2, A3 | REC19210-ZW1-B02 | CEF500337 | 23,35 | 87,8 31 |
| | BF90AT | REC47-43026Q02 | CEF500301 | 22,4 | 89 32,5 |
| | BF90AV, AX, DK0, DK2 | REC19210-ZW1-B02 | CEF500337 | 23,35 | 87,8 31 |
| | BF90DK4, DK5 | REC19210-ZY9-H01 | | | |
| | BFP10B1, B2, D1, D2 | REC19210-ZW9-013 | CEF500347 | 13 | 45,6 14,8 |
| | BFP10B1, B2, D2 | REC19210-ZW9-A32 | CEF500348 | 16,2 | 45,6 14,8 |
| | BFP60A, AK1 | REC19210-ZV5-003 | CEF500338 | 17,2 | 55,9 20,2 |
| | BFP8B1, B2, D1, D2, D3 | REC19210-ZW9-013 | CEF500347 | 13 | 45,6 14,8 |
| | BFP8B1, B2, D1, D2, D3 | REC19210-ZW9-A32 | CEF500348 | 16,2 | 45,6 14,8 |
| | BFP9,9D, D1, D2 | REC19210-ZW9-A32 | CEF500348 | 16,2 | 45,6 14,8 |
| | BFP9,9D1, D2, D3 | REC19210-ZW9-013 | CEF500347 | 13 | 45,6 14,8 |
| | BFPD1 | REC19210-ZW9-A32 | CEF500348 | 16,2 | 45,6 14,8 |
| | BFT100AK1 | REC19210-ZY9-H01 | | | |
| | BFT80AK1 | REC19210-ZY9-H01 | | | |

| CHAVETA | KEY | CHAVETTA | CLAVETTE | | | | | | | | |
|--|-------------------------------|----------|------------------|---------------|---|---|-----|-----|------------------|-------------------------------|---|
| <table border="1"> <thead> <tr> <th>REF</th> <th>OEM</th> </tr> </thead> <tbody> <tr> <td>REC90752-ZV4-650</td> <td>90752-ZV4-650</td> </tr> </tbody> </table> <p>  BF8C, CX BF9.9AM, B, AX, BX, AY BF15AM, B, A1, A2, AX, B2, BX, A3, AY </p> | REF | OEM | REC90752-ZV4-650 | 90752-ZV4-650 |  | <table border="1"> <thead> <tr> <th>REF</th> <th>OEM</th> </tr> </thead> <tbody> <tr> <td>REC90752-ZW1-B02</td> <td>90752-ZW1-B02 9075-ZW1-003</td> </tr> </tbody> </table> <p>  BF80A, BF100A BF150A4, AK2 BF75A1, AV, AX, DK2, DK3, A2, A3 BF90A1, AV, AX, DK0, DK2, DK4, A2, A3 BF115A1, A2, A3, AX, D, DK1 BF130A1, A2, A3, AX BF135A4, AK2 </p> | REF | OEM | REC90752-ZW1-B02 | 90752-ZW1-B02 9075-ZW1-003 |  |
| REF | OEM | | | | | | | | | | |
| REC90752-ZV4-650 | 90752-ZV4-650 | | | | | | | | | | |
| REF | OEM | | | | | | | | | | |
| REC90752-ZW1-B02 | 90752-ZW1-B02 9075-ZW1-003 | | | | | | | | | | |
| <table border="1"> <thead> <tr> <th>REF</th> <th>OEM</th> </tr> </thead> <tbody> <tr> <td>REC90752-ZV7-000</td> <td>90752-ZV7-000</td> </tr> </tbody> </table> <p>  BF25D4, DK2, A, A1, AX, A2, A3 BF30D4, DK2, A, A1, AX, A2, A3 BF20A, AX, A2 </p> | REF | OEM | REC90752-ZV7-000 | 90752-ZV7-000 |  | <table border="1"> <thead> <tr> <th>REF</th> <th>OEM</th> </tr> </thead> <tbody> <tr> <td>REC90752-ZV5-003</td> <td>90752-ZV5-003</td> </tr> </tbody> </table> <p>  BF60A, AK1 BF50A4, D, DK2, A, A1, A2, AX, A3, AY BF35AM BF40B, B2, BX, D, DK2, A, A1, A2, AX, E, A3, AY, A4 BF45AM </p> | REF | OEM | REC90752-ZV5-003 | 90752-ZV5-003 |  |
| REF | OEM | | | | | | | | | | |
| REC90752-ZV7-000 | 90752-ZV7-000 | | | | | | | | | | |
| REF | OEM | | | | | | | | | | |
| REC90752-ZV5-003 | 90752-ZV5-003 | | | | | | | | | | |
| <table border="1"> <thead> <tr> <th>REF</th> <th>OEM</th> </tr> </thead> <tbody> <tr> <td>REC90752-ZY3-003</td> <td>90752-ZY3-003</td> </tr> </tbody> </table> <p>  BF225A2, A3, A6, AK2, AK3 BF175A3, A6, AK1, AK2, AK3 BF200A2, A3, A6, AK1, AK2, AK3 BF250A, AK1 </p> | REF | OEM | REC90752-ZY3-003 | 90752-ZY3-003 |  | | | | | | |
| REF | OEM | | | | | | | | | | |
| REC90752-ZY3-003 | 90752-ZY3-003 | | | | | | | | | | |

| BOMBA DE AGUA | WATER PUMP | POMPA ACQUA | POMPE À EAU | | | | | | | | |
|---|-------------------|-------------------|-----------------------|---------------|---|--|-----|-----|------------------|---------------|---|
| JUNTAS BOMBA | WATER PUMP GASKET | GUARNIZIONE POMPA | JOINTS DE POMPE A EAU | | | | | | | | |
| <table border="1"> <thead> <tr> <th>REF</th> <th>OEM</th> </tr> </thead> <tbody> <tr> <td>REC8172761</td> <td>19231-ZW1-003</td> </tr> </tbody> </table> <p>  BF75A BF90A </p> | REF | OEM | REC8172761 | 19231-ZW1-003 |  | <table border="1"> <thead> <tr> <th>REF</th> <th>OEM</th> </tr> </thead> <tbody> <tr> <td>REC19232-ZV1-A10</td> <td>19232-ZV1-A10</td> </tr> </tbody> </table> <p>  BF4.5B, BX, BK2, B2, B4, B6, BK0 BF5A1, AM, AX, AK2, A2, A3, A4 </p> | REF | OEM | REC19232-ZV1-A10 | 19232-ZV1-A10 |  |
| REF | OEM | | | | | | | | | | |
| REC8172761 | 19231-ZW1-003 | | | | | | | | | | |
| REF | OEM | | | | | | | | | | |
| REC19232-ZV1-A10 | 19232-ZV1-A10 | | | | | | | | | | |
| <table border="1"> <thead> <tr> <th>REF</th> <th>OEM</th> </tr> </thead> <tbody> <tr> <td>REC19232-881-850</td> <td>19232-881-850</td> </tr> </tbody> </table> <p>  BF6B, BX, D6 BF8AX, B, BX, AK, AM </p> | REF | OEM | REC19232-881-850 | 19232-881-850 |  | <table border="1"> <thead> <tr> <th>REF</th> <th>OEM</th> </tr> </thead> <tbody> <tr> <td>REC19242-ZV5-000</td> <td>19242-ZV5-000</td> </tr> </tbody> </table> <p>  BF20A, AX, A2 BF35AM BF40B, B2, BX, A4, D, DK2, A, A1, A2, AX, A3, AY BF45AM BF25D4, DK2, A, A1, AX, A2, A3 BF50A4, D, DK2, A, A1, A2, A3, AY BF30D4, DK2, A, A1, AX, A2, A3 </p> | REF | OEM | REC19242-ZV5-000 | 19242-ZV5-000 |  |
| REF | OEM | | | | | | | | | | |
| REC19232-881-850 | 19232-881-850 | | | | | | | | | | |
| REF | OEM | | | | | | | | | | |
| REC19242-ZV5-000 | 19242-ZV5-000 | | | | | | | | | | |
| <table border="1"> <thead> <tr> <th>REF</th> <th>OEM</th> </tr> </thead> <tbody> <tr> <td>REC19234-881-850</td> <td>19234-881-850</td> </tr> </tbody> </table> <p>  BF6B, BX, D6 BF8AX, B, BX, AK, AM </p> | REF | OEM | REC19234-881-850 | 19234-881-850 |  | <table border="1"> <thead> <tr> <th>REF</th> <th>OEM</th> </tr> </thead> <tbody> <tr> <td>REC27-430331</td> <td>19234-ZW1-003</td> </tr> </tbody> </table> <p>  BF75A BF90A </p> | REF | OEM | REC27-430331 | 19234-ZW1-003 |  |
| REF | OEM | | | | | | | | | | |
| REC19234-881-850 | 19234-881-850 | | | | | | | | | | |
| REF | OEM | | | | | | | | | | |
| REC27-430331 | 19234-ZW1-003 | | | | | | | | | | |
| <table border="1"> <thead> <tr> <th>REF</th> <th>OEM</th> </tr> </thead> <tbody> <tr> <td>REC27-430472</td> <td>19242-ZW1-003</td> </tr> </tbody> </table> <p>  BF75A BF90A </p> | REF | OEM | REC27-430472 | 19242-ZW1-003 |  | <table border="1"> <thead> <tr> <th>REF</th> <th>OEM</th> </tr> </thead> <tbody> <tr> <td>REC19234-ZY3-000</td> <td>19234-ZY3-000</td> </tr> </tbody> </table> <p>  BF175A3, A6, AK1, AK2, AK3 BF200A2, A3, A6, AK1, AK2, AK3 BF225A2, A3, A6, AK1, AK2, AK3 </p> | REF | OEM | REC19234-ZY3-000 | 19234-ZY3-000 |  |
| REF | OEM | | | | | | | | | | |
| REC27-430472 | 19242-ZW1-003 | | | | | | | | | | |
| REF | OEM | | | | | | | | | | |
| REC19234-ZY3-000 | 19234-ZY3-000 | | | | | | | | | | |
| <table border="1"> <thead> <tr> <th>REF</th> <th>OEM</th> </tr> </thead> <tbody> <tr> <td>REC19232-ZV4-610</td> <td>19232-ZV4-610</td> </tr> </tbody> </table> <p>  BF15AK, AM, B, A1, A2, AX, B2, BX, A1, A2, A3, AY BF9.9AK, AM, B, AX, BX, AY BF8C, CX </p> | REF | OEM | REC19232-ZV4-610 | 19232-ZV4-610 |  | <table border="1"> <thead> <tr> <th>REF</th> <th>OEM</th> </tr> </thead> <tbody> <tr> <td>REC19233-ZV5-000</td> <td>19233-ZV5-000</td> </tr> </tbody> </table> <p>  BF35AM BF40B, B2, BX, A4, D, DK2, A, A1, A2, AX, AY BF45AM BF25D4, DK2, A, A1, AX, A2, A3 BF30D4, K2, A, A1, AX, AZ, A3 BF50A4, D, DK2, A, A1, A2, AX </p> | REF | OEM | REC19233-ZV5-000 | 19233-ZV5-000 |  |
| REF | OEM | | | | | | | | | | |
| REC19232-ZV4-610 | 19232-ZV4-610 | | | | | | | | | | |
| REF | OEM | | | | | | | | | | |
| REC19233-ZV5-000 | 19233-ZV5-000 | | | | | | | | | | |
| <table border="1"> <thead> <tr> <th>REF</th> <th>OEM</th> </tr> </thead> <tbody> <tr> <td>REC27-8172771</td> <td>19232-ZW1-003</td> </tr> </tbody> </table> <p>  BF75A BF90A </p> | REF | OEM | REC27-8172771 | 19232-ZW1-003 |  | | | | | | |
| REF | OEM | | | | | | | | | | |
| REC27-8172771 | 19232-ZW1-003 | | | | | | | | | | |

RETÉN CUERPO DE BOMBA

SEAL WATER PUMP

TENUTE CORPO POMPA

JOINTS SPI DE POMPE À EAU

| REF | OEM |
|------------------|---------------|
| REC91252-ZV1-003 | 91252-ZV1-003 |

 B4.5B, BX, BK2, B4, B6
 BF5A1, H, AK, AM, AX, AK2, A2, A3, A4
 BF8B1, D1, D2, B2, DK2, D3, D4
 BF9.9DK2, D1, D2, D3
 BF10B1, D1, D4, DK2, B2, D2
 BF50F



| REF | OEM |
|------------------|---------------|
| REC91252-935-004 | 91252-935-004 |

 BF9.9A
 BF15A
 BF100A, B, C, D, E, F
 BF75A, B, C, D, K2, K3, E, F
 BF15AH, AK, AM, B, A1, A2, AX, B2, BX, A3, AY
 BF9.9AH, AK, AM, B, AX, BX, AY
 BF6BX, D6
 BF8AX, B, BX, C, CX, AH, AK, AM



KITS DE REPARACIÓN BOMBA DE AGUA

WATER PUMP SERVICE KITS

KIT RICAMBI POMPA ACQUA

KIT POMPE À EAU

| REF | OEM |
|------------------|--------------------------------|
| REC06192-ZV1-C00 | 06192-ZV1-C00 06192-ZV1-000 |

 BF4.5B, BK2, BK0
 BF5A1, AM, AX, AK2, A2, A3, A4



| REF | OEM |
|------------------|---|
| REC06193-ZV5-020 | 06193-ZV5-020 06193-ZV5-000 06193-ZV5-010 |

 BF40A4, D, DK2, DK4
 BF50A4, D, DK2, DK4



new

| REF | OEM |
|------------------|---------------|
| REC06192-881-C00 | 06192-881-C00 |

 BF6B, BX, D6
 BF8AX, B, BX, AM



| REF | OEM |
|------------------|---------------|
| REC06192-ZW9-A30 | 06192-ZW9-A30 |

 BFP8D, BF8B2, BF8D2
 BFP9.9D (XL)
 BF15D
 BF20D
 BF10D
 BFP10D



new

| REF | OEM |
|------------------|--------------------------------|
| REC06192-ZV4-000 | 06192-ZV4-000 19210-ZV4-651 |

 BF8C, CX
 BF9.9A
 BF15A2, A3, B2



| REF | OEM |
|------------------|--------------------------------|
| REC06192-ZV1-305 | 06192-ZV1-305 06192-ZW1-305 |

 BF75AT
 BF90AT



| REF | OEM |
|------------------|--------------------------------|
| REC06192-ZV7-000 | 06192-ZV7-000 06192-ZW2-000 |

 BF25D4, DK2, A2, A3
 BF30D4, DK2, A2, A3
 BF20A2



| REF | OEM |
|------------------|--------------------------------|
| REC06192-ZV1-000 | 06192-ZW1-000 06192-ZV1-000 |

 BF115A2, A3
 BF130A2, A3
 BF75DK0, DK1, A2, A3, DK2
 BF90 DK0, DK1, A2, A3, DK2

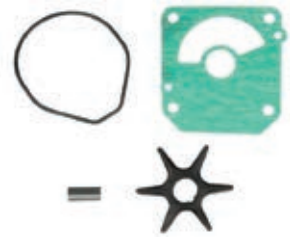

| REF | OEM |
|------------------|---------------|
| REC06192-ZV5-003 | 06192-ZV5-003 |

 BF35AM
 BF40B, B2, BX, A4, D, DK2, AA1, A2, AX, A3
 BF45AM
 BF50A4, D, DK2, A, A21, A2, AX, A3



| REF | OEM |
|------------------|---------------|
| REC06192-ZY6-000 | 06192-ZY6-000 |

 BF115D, DK1
 BF135A4, AK2
 BF150A4, AK2

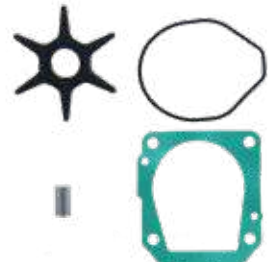

| REF | OEM |
|----------------|---------------|
| REC47-43026Q06 | 19021-ZW1-003 |

 BF75AT
 BF90AT



| REF | OEM |
|------------------|--------------------------------|
| REC06192-ZY3-000 | 06192-ZY3-000 06192-ZX2-000 |

 BF175A3, A6, AK1, AK2, AK3
 BF200A2, A3, A6, AK1, AK2, AK3
 BF225A2, A3, A6, AK1, AK2, AK3
 BF250A

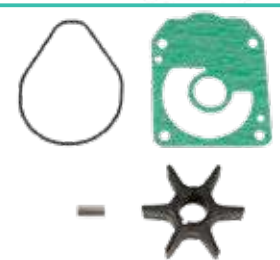



ÁNODO

ANODE

ANODI

ANODE

| ZN | KG (KG) | AL | KG (KG) | OEM |
|-----------------|---------|------------------|---------|--------------------------------|
| CM06411-ZV5-000 | 0,36 | CM06411-ZV5-000A | 0,14 | 06411-ZV5-000 06411-ZV5-020 |

BF35, 40, 45, 50
150 x 35 mm

| ZN | KG (KG) | AL | KG (KG) | OEM |
|----------|---------|-----------|---------|--------------------------------|
| CM826134 | 0,25 | CM826134A | 0,10 | 41109-ZW1-003 12155-ZV5-000 |

BF20-->BF250 HP

| ZN | KG (KG) | AL | KG (KG) | OEM |
|-----------------|---------|------------------|---------|--------------------------------|
| CM06411-ZW1-000 | 0,83 | CM06411-ZW1-000A | 0,33 | 06411-ZW1-000 06411-ZW1-020 |

BF75 --> BF225 HP
220 x 50 mm

| ZN | KG (KG) | AL | KG (KG) | OEM |
|-----------------|---------|------------------|---------|---------------|
| CM41109-ZW1-B00 | 0,22 | CM41109-ZW1-B00A | 0,11 | 41109-ZW1-B00 |

BF40-->BF250 HP

| ZN | KG (KG) | AL | KG (KG) | OEM |
|----------------|---------|-----------------|---------|--------------|
| CM6E0-45251-11 | 0,10 | CM6E0-45251-11A | 0,04 | 2155-ZV5-000 |

BF2-->BF250 HP

| ZN | KG (KG) | AL | KG (KG) | OEM |
|-----------------|---------|------------------|---------|--------------|
| CM41107-ZW1-B01 | 0,44 | CM41107-ZW1-B01A | 0,20 | 41107ZW1-B01 |

BF75-->BF130 HP

| ZN | KG (KG) | AL | KG (KG) | OEM |
|-------------------|---------|------------------|---------|--------------------------------|
| CM41106-ZW9-09000 | 0,99 | CM41106-ZW9-000A | | 41106ZW909000 41106-ZW9-000 |

BF8-->BF50HP

| ZN | KG (KG) | AL | KG (KG) | OEM |
|---------|---------|----------|---------|-------------------------------|
| CM31640 | 0,45 | CM31640A | 0,21 | 06412-ZV1-000 411072ZW1003 |

BF75, 90, 115, 130

| ZN | KG (KG) | AL | KG (KG) | OEM |
|---------------|---------|----------------|---------|-----------------------------|
| CM41107-ZV500 | 0,29 | CM41107-ZV500A | 0,11 | 41107ZV500 06412-ZV5-000 |

BF20--> BF50HP

| ZN | KG (KG) | AL | KG (KG) | OEM |
|----------------|---------|-----------------|---------|--------------|
| CM664-45371-01 | 0,27 | CM664-45371-01A | 0,10 | 064-45371-01 |

BF20--> BF50HP

KITS DE ÁNODOS

ANODES KIT

KIT ANODI

KIT ANODES

| AL | MG | |
|----------------|----------------|----------------|
| CMHBF4050KITA | CMHBF4050KITM | BF40 --> BF50 |
| CMHBF35225KITA | CMHBF35225KITM | BF35 --> BF225 |
| CMHBF75115KITA | CMHBF75115KITM | BF90 --> BF115 |



new

HONDA

RECAMBIOS MARINOS

ÁNODO

ANODE

ANODI

ANODE

| ZN | OEM | KG (KG) |
|----------|--------------------------------|---------|
| TEN01404 | 06411-ZV5-000 06411-ZV5-020 | 0,380 |



BF35-->BF50 HP

| ZN | OEM | KG (KG) |
|----------|---------------|---------|
| TEN01401 | 41106-935-812 | 0,080 |



Serie 8 /25HP

| ZN | OEM | KG (KG) |
|----------|---------------|---------|
| TEN01406 | 06411-ZV1-000 | 0,860 |



BF75-->BF225 HP

| ZN | OEM | KG (KG) |
|----------|---------------|---------|
| TEN01402 | 41106-ZV4-650 | 0,090 |



BF2-->BF15 HP

| ZN | OEM | KG (KG) |
|----------|---------------|---------|
| TEN01405 | 06411-ZV1-000 | 0,250 |



Serie 75 - 130 HP

| ZN | OEM | KG (KG) |
|----------|--------------|---------|
| TEN01400 | 41106-ZW-000 | 0,020 |



Serie 8 /25HP

| ZN | OEM | KG (KG) |
|----------|---------------|---------|
| TEN01407 | 41109-ZW1-B00 | 0,230 |



BF40-->BF250 HP

| ZN | OEM | KG (KG) |
|----------|---------------|---------|
| TEN01412 | 06412-ZV5-000 | 0,210 |



| ZN | OEM | KG (KG) |
|----------|---------------|---------|
| TEN01408 | 12155-ZV4-A00 | 0,040 |



BF8->BF250 HP

| ZN | OEM | KG (KG) |
|----------|---------------|---------|
| TEN01403 | 41107-ZV5-000 | 0,280 |



BF20-->BF50 HP

| ZN | OEM | KG (KG) |
|------------|---------------|---------|
| TEN01408/1 | 12155-ZV5-000 | 0,030 |



BF20-->BF250 HP

| ZN | OEM | KG (KG) |
|----------|-----------------|---------|
| TEN01410 | 41107-ZW1-B01ZA | 0,550 |



Serie 75 - 90 - 115 - 130 HP

| ZN | OEM | KG (KG) |
|----------|---------------|---------|
| TEN01409 | 41106-ZW9-000 | 0,050 |



BF8-->BF50 HP

| ZN | OEM | KG (KG) |
|----------|------------------|---------|
| TEN01411 | 41107-ZV1-003-ZA | 0,480 |



BF75-->BF130 HP

KITS DE ÁNODOS

ANODES KIT

KIT ANODI

KIT ANODES

| ZN | OEM |
|---------------|--|
| TENKITHONDABF | TEN01410 x 1 TEN01406 x 1 TEN01407 x 2 |



BF75+

new

PARTES DEL MOTOR ENGINE PARTS

PARTI MOTORE PIECES MOTEUR

JUNTAS DE MOTOR ENGINE GASKET GUARNIZIONI DE MOTORE JOINTS DE MOTEUR

JUNTAS DE CULATA CYLINDER HEAD GASKET GUARNIZIONE DE TESTATA JOINTS DE CULASSE

| REF | OEM |
|------------------|---------------|
| REC12251-ZV7-004 | 12251-ZV7-004 |

 BF20A, A2, AX
 BF25A, A1, 2, A3, AX
 BF30A, A1, A2, A3, AX
 VF25A2

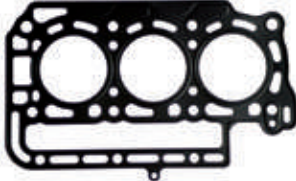

| REF | OEM |
|------------------|--------------------------------|
| REC12251-ZW1-014 | 12251-ZW1-014 12251-ZW1-004 |

 BF40A4, D, K2, DK4
 BF50A4, BF50D, DK2, DK4

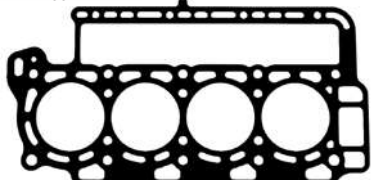

| REF | OEM |
|------------------|-----------------------------------|
| REC12251-ZV5-003 | 12251-ZW4-H01 12251-ZV5-000/03 |

 BF35AM
 BF40B, BX, A, A1, AX, AY, A4, D,
 DK2, DK4
 BF45AM
 BF50A, A1, A4, AX, AY, D, DK2, DK4

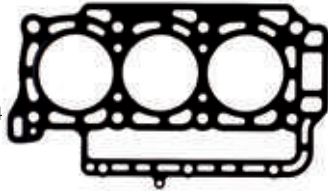

| REF | OEM |
|------------------|------------------------------------|
| REC12251-ZW5-023 | 12251-ZW5-023 12251-ZW5-000/013 |

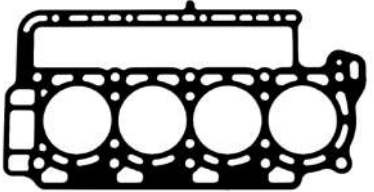

 BF115A1, A2, A3, AX
 BF130A1, A2, A3, AX



JUNTAS BASE DE MOTOR CYLINDER GASKET GUARNIZIONE BASE MOTORE JOINTS DE TÊTE MOTRICE

| REF | OEM |
|------------------|---------------|
| REC23172-ZW1-013 | 23172-ZW1-013 |

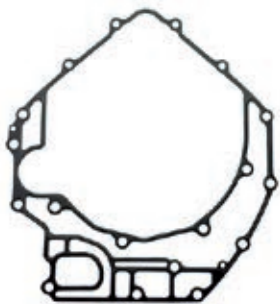
 BF75A1, A2, A3
 BF90A1, A2, A3



| REF | OEM |
|------------------|--------------------------------|
| REC23172-ZW5-013 | 23172-ZW5-013 23172-ZW5-000 |

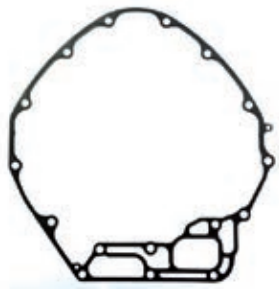

 BF115A1, A2, A3, AX
 BF130A1, A2, A3, AX



JUNTAS BOMBA ACEITE GASKET, OIL PUMP GUARNIZIONE POMPA OLIO JOINTS DE POMPE A HUILE

| REF | OEM |
|------------------|---------------|
| REC15112-ZW5-003 | 15112-ZW5-003 |

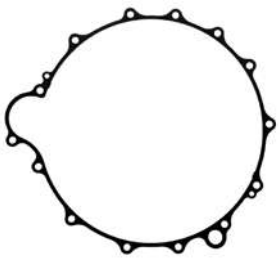
 BF115A1, A2, A3, AX
 BF130A1, A2, A3, AX



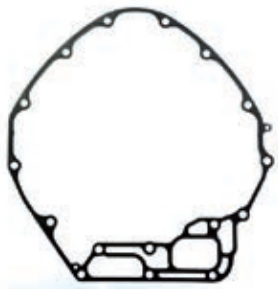

JUNTAS SILENCIOSO GASKET, MUFFLER GUARNIZIONE SILENZIATORE JOINTS DE SILENCIEU

| REF | OEM |
|------------------|---------------|
| REC17384-ZW4-000 | 17384-ZW4-000 |

 BF25D4, DK2, A4
 BF30D4, DK2, A4





HONDA

RECAMBIOS
MARINOS

KIT DE JUNTAS

GASKET KIT

KIT GUARNIZIONE

KIT JOINTS

| REF | OEM |
|-----------------|---------------|
| RM061A1-ZV0-000 | 061A1-ZV0-000 |

 BF20F



| REF | OEM |
|-----------------|--------------------------------|
| RM06111-ZW1-020 | 06111-ZW1-000 06111-ZW1-020 |

 BF75A1, AT, AV, AX
BF90, A1, AT, AV, AX



JUNTA TAPÓN DE DRENAJE

O-RING DRAIN CAP

GUARNIZIONE TAPPO DRENAGIO

JOINT DE VIDANGE

| REF | OEM |
|--------------|-----------|
| REC12-191833 | 12-191833 |



CORREAS DE DISTRIBUCIÓN

TIMING BELT

CINGHIE DISTRIBUZIONE

COURROIES DE DISTRIBUTION

| REF | OEM |
|-----------------|--------------------------------|
| RM14400-921-024 | 14400-921-024 14400-921-010 |

 F8AX, B, BX, AH, AK, AM
BF6BX, D6
BF75A, B, C, D, K2, K3, E, F
BF100A, B, C, D, E, F



| REF | OEM |
|-----------------|---------------|
| RM14400-ZV4-004 | 14400-ZV4-004 |

 BF8C, CX
BF9.9AH, AK, AM, B, AX, BX, AY
BF15AH, AK, AM, B, A1, A2, AX, B2, A3, AY



| REF | OEM |
|------------------|--------------------------------|
| REC14400-ZV5-014 | 14400-ZV5-004 14400-ZV5-014 |

 BF35AM
BF40B, B2, BX, A, A1, A2, AX, AY
BF45AM
BF50A, A1, A2, AX, AY

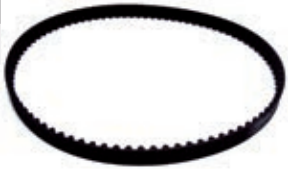

| REF | OEM |
|------------------|---------------|
| REC14400-ZZ3-004 | 14400-ZZ3-004 |

 BF60A, AK1
BFP60AK1
BF40E



new

| REF | OEM |
|-----------------|---------------|
| RM14400-ZW1-004 | 14400-ZW1-004 |

 BF75A1, AT, AV, AX, A2, A3
BF90A1, AT, AV, AX, A2, A3





SISTEMA DE ESCAPE Y ADMISIÓN EXHAUST & INTAKE SYSTEM

SISTEMA DI SCARICO E ASPIRAZIONE SYSTÈME D'ÉCHAPPEMENT ET D'ADMISSION

| SISTEMA DE ESCAPE | EXHAUST SYSTEM | SISTEMA SCARICO | SYSTÈME D'ÉCHAPPEMENT |
|-------------------|----------------|-----------------|-----------------------|
|-------------------|----------------|-----------------|-----------------------|

| RETÉN VÁLVULA | VALVE SEALS | TENUTE | JOINT DE SOUPEPE |
|---------------|-------------|--------|------------------|
|---------------|-------------|--------|------------------|

| REF | OEM | |
|---|---|---|
| REC12209-6B4-681 | 12209-GB4-681 |  |
|  | BF8B1, B2, D1, D2, DK2, D3, D4 BF9.9DK2, D1, D2, D3 BF10B1, D1, D4, DK2, D2 | |

| SISTEMA DE ADMISIÓN | INTAKE SYSTEM | SISTEMA ASPIRAZIONE | SYSTÈME D'ADMISSION |
|---------------------|---------------|---------------------|---------------------|
|---------------------|---------------|---------------------|---------------------|

| RETÉN VÁLVULA | VALVE SEALS | TENUTE | JOINT DE SOUPEPE |
|---------------|-------------|--------|------------------|
|---------------|-------------|--------|------------------|





| REF | OEM | |
|---|---|--|
| REC12209-6B4-681 | 12209-GB4-681 |  |
|  | BF8B1, B2, D1, D2, DK2, D3, D4 BF9.9DK2, D1, D2, D3 BF10B1, D1, D4, DK2, D2 | |





| JUNTAS | GASKET, | GUARNIZIONE | JOINT |
|--------|---------|-------------|-------|
|--------|---------|-------------|-------|

| REF | OEM | | |
|---|---|---|---|
| REC16221-ZW9-000 | 16221-ZW9-000 |  |  |
|  | BF8B1, B2, D1, D2, DK2, D3, D4 BF9.9DK2, D1, D2, D3 BF10B1, D1, D4, DK2, B2, D2 | |  |

| REF | OEM | | |
|---|--------------------------------------|---|---|
| REC16201-881-850 | 16201-881-850 |  |  |
|  | BF6B, BX, D6 BF8AX, B, BX, AK, AM | |  |

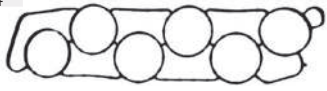
| REF | OEM | | |
|---|---|---|---|
| REC16221-ZV4-610 | 16221-ZV4-610 |  |  |
|  | BF15AK, AM, B, A1, A2, AX, B2, BX, A3, A4 BF9.9AK, AM, B, AX, BX, AY BF8C, CX | |  |

| REF | OEM | | |
|---|--|---|---|
| REC16221-ZW1-000 | 16221-ZW1-000 |  |  |
|  | BF75A1, AT, AV, AX, A2, A3 BF90A1, AT, AV, AX, A2, A3 | |  |

| REF | OEM | | |
|---|--|---|---|
| REC17105-ZY3-004 | 17105-ZY3-004 |  |  |
|  | BF250A BF175A3, A6, AK1, AK2, AK3 BF200A2, A3, A6, AK1, AK2, AK3 BF225A2, A3, A6, AK1, AK2, AK3 | |  |

UNIDADES DE TRANSMISIÓN UNIT DRIVES & COMPONENTS

UNITÀ DI TRASMISSIONE EMBASES ET PIÈCES

DESPIECE COLAS

GEAR CASE PARTS

PARTI PIEDI

PIECES D'EMBASES

BF25 --> BF50

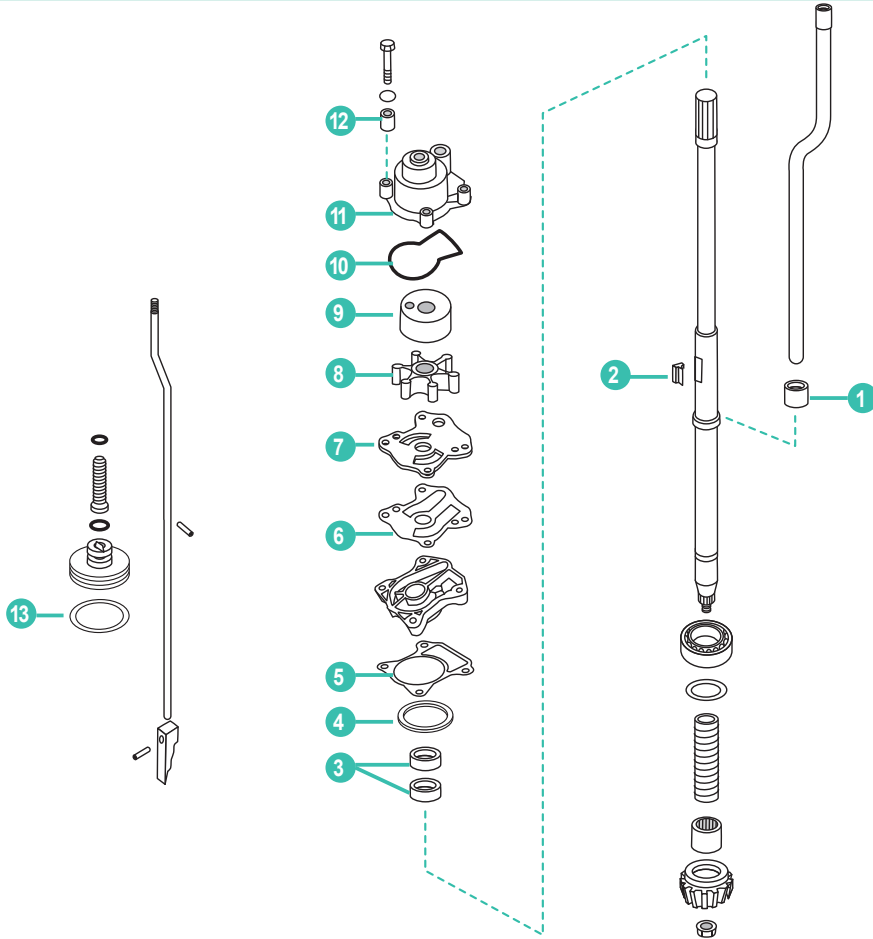

| | REF | OEM | | | | |
|----|------------------|---------------|--------------------|-------------------------|----------------------|-----------------------|
| 1 | REC19253-ZV5-000 | 19253-ZV5-000 | RETEN | SEAL | TENUTA | JOINT SPI |
| 2 | REC90752-ZV5-003 | 90752-ZV5-003 | CHAVETA | KEY | CHIUSURA | CLAVETTE |
| 3 | REC91251-ZV5-003 | 91251-ZV5-003 | RETEN | SEAL | TENUTA | JOINT SPI |
| 4 | REC91351-740-003 | 91351-740-003 | TORICA | O-RING | O-RING | JOINT TORIQUE |
| 5 | REC19242-ZV5-000 | 19242-ZV5-000 | JUNTA DE LA BOMBA | GASKET PUMPCASE | GUARNIZIONE POMPA | JOINT DE POMPE |
| 6 | REC19233-ZV5-000 | 19233-ZV5-000 | JUNTA | GASKET | GUARNIZIONE | JOINT |
| 7 | REC19231-ZV5-000 | 19231-ZV5-000 | PLACA | PLATE | PIASTRA | PLAQUE |
| 8 | REC19210-ZV5-003 | 19210-ZV5-003 | IMPULSOR | IMPELLER | GIRANTE | TURBINE |
| 9 | REC19223-ZV5-000 | 19223-ZV5-000 | TAPA DE LA BOMBA | COVER, INNER WATER PUMP | COPERCHIO POMPA ACQA | INSERT DE POMPE À EAU |
| 10 | REC91356-ZV5-000 | 91356-ZV5-000 | TORICA | O-RING | O-RING | JOINT TORIQUE |
| 11 | REC19221-ZV5-000 | 19221-ZV5-000 | CUERPO DE LA BOMBA | HOUSING, WATER PUMP | CORPO POMPA | CORS DE POMPE À EAU |
| 12 | REC91555-ZV5-000 | 91555-ZV5-00 | PASADOR | PIN | SPINOTTO | PIN |
| 13 | REC91353-ZV5-003 | 91353-ZV5-003 | TORICA | O-RING | O-RING | JOINT TORIQUE |

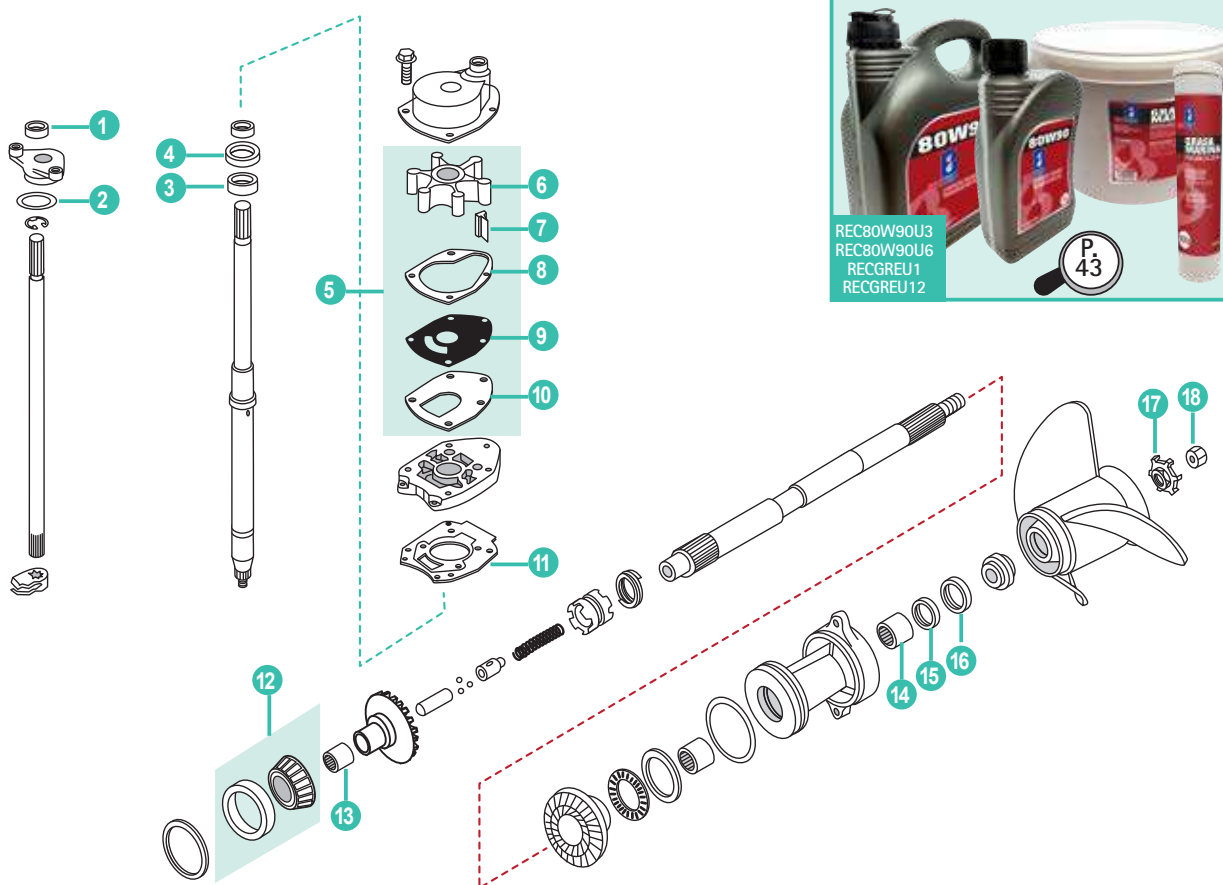

| | REF | OEM | | | | |
|----|------------------|---------------|--------------------|-----------------|-------------------|-------------------------|
| 1 | REC26-8164641 | 91253-ZW1-003 | RETÉN ACEITE | OIL SEAL | PARAOLIO | JOINT SPI |
| 2 | REC25-457101 | 91353-ZW1-003 | TORICA | O-RING | O-RING | JOINT TORIQUE |
| 3 | REC26-43036 | 91254-ZW1-003 | RETÉN ACEITE | OIL SEAL | PARAOLIO | JOINT SPI |
| 4 | REC26-43035 | 91251-ZW1-003 | RETÉN ACEITE | OIL SEAL | PARAOLIO | JOINT SPI |
| 5 | REC47-43026Q06 | 19021-ZW1-003 | KIT BOMBA AGUA | WATER PUMP KIT | KIT POMPA ACQUA | KIT POMPE À EAU |
| 6 | REC47-43026Q02 | 19120-ZW1-303 | IMPULSOR | IMPELLER | GIRANTE | TURBINE |
| 7 | REC90752-ZW1-B02 | 90752-ZW1-003 | CHAVETA IMPELLER | KEY | CHIUSSURA | CLAVETTE TURBINE |
| 8 | REC27-8172771 | 19232-ZW1-003 | JUNTA DE LA BOMBA | GASKET PUMPCASE | GUARNIZIONE POMPA | JOINT DE POMPE |
| 9 | REC8172761 | 19231-ZW1-003 | BASE INOX | OUTER PLATE | PIASTRA INOX | BASE INOX |
| 10 | REC27-430331 | 19234-ZW1-003 | JUNTA DE LA BOMBA | GASKET PUMPCASE | GUARNIZIONE POMPA | JOINT DE POMPE |
| 11 | REC27-430472 | 19242-ZW1-003 | JUNTA | GASKET | GUARNIZIONE | JOINT |
| 12 | REC31-30894A1 | 91051-ZW1-003 | RODAMIENTO AVAN. | BEARING FORWARD | CUSCINETTO AVANTI | ROULEMENT MARCHE AVANTE |
| 13 | REC31-30895T | 91057-ZW1-003 | RODAMIENTO | BEARING | CUSCINETTO | ROULEMENT |
| 14 | REC387247 | 91053-ZW1-003 | RODAMIENTO AGUJAS | NEEDLE BEARING | CUSCINETTO ASSE | ROULEMENT A AIGUILLE |
| 15 | REC26-76868 | 91252-ZW1-003 | RETEN | SEAL | TENUTA | JOINT SPI |
| 16 | REC26-70081 | 91351-ZW1-003 | RETEN | SEAL | TENUTA | JOINT SPI |
| 17 | REC90508-ZW1-003 | 90508-ZW1-003 | ARANDELA SEGURIDAD | WASHER TAB | RONDELLA | RONDELLE FREIN |
| 18 | REC90301-ZW1-003 | 90301-ZW1-003 | TUERCA HELICE | NUT PROPELLER | DADO ELICHE | ÉCROU |

COMPONENTES DE COLA

DRIVE COMPONENTS

COMPONENTI PIEDI

PIECES D' EMBASES

KITS JUNTAS Y RETENES

SEALS KITS

KIT GUARNIZIONE E TENUTE

KITS JOINTS D'EMBASE

| REF | OEM |
|--------------|-----|
| REC18-8362-1 | |

Series 14ZV50M
 BF35/45 AM BF40/50 A, AW, AX

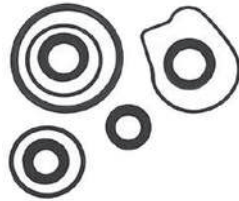

| REF | OEM |
|------------|-----|
| REC18-8363 | |

 BF9.9
BF15



| REF | OEM |
|------------|-----|
| REC18-8365 | |

 BF115
BF130



| REF | OEM |
|------------|-----|
| REC18-8366 | |

 BF75
BF90

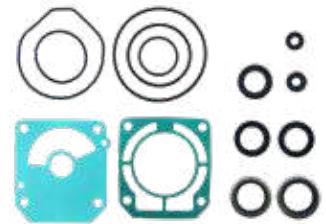

RETENES EJE DE TRASMISION

SEALS DRIVE SHAFT

TENUTE ASSE DI TRASMISSIONE

JOINTS SPI ARBRE DE TRANSMISSION

| REF | OEM |
|-------------|---------------|
| REC26-43036 | 91254-ZW1-003 |

 BF75AT
BF90AT



| REF | OEM |
|-------------|---------------|
| REC26-43035 | 91251-ZW1-003 |

 BF75AT
BF90AT



RETENES EJE DE HÉLICE

SEALS PROPELLER SHAFT

TENUTE ASSE ELICA

JOINTS SPI ARBRE D'HÉLICE

| REF | OEM |
|-------------|---------------|
| REC26-76868 | 91252-ZW1-003 |

 BF75AT
BF90AT



| REF | OEM |
|-------------|--------------------------------|
| REC26-70081 | 91255-ZW1-003 91351-ZW1-003 |

 BF75AT
BF90AT



RETENES EJE DE CAMBIO

SEALS SHIFT SHAFT

TENUTE ASSE DI CAMBIO

JOINTS SPI ARBRE DE CHANGEMENT

| REF | OEM |
|---------------|---------------|
| REC26-8164641 | 91253-ZW1-003 |

 BF75AT
BF90AT



JUNTA EJE SELECTOR

O-RING DRIVE SHAFT

GUARNIZIONE ASSE TRASMISSIONE

JOINTS D'ARBRE DE SELECTEUR

| REF | OEM |
|--------------|---------------|
| REC25-457101 | 91353-ZW1-003 |

 DF75AT
DF90AT



TUERCA DIÁBOLO

NUT, GEARCASE END

DADO DIAVOLO

ECROU DE DIABOLO

| REF | OEM |
|------------------|---------------|
| REC41109-ZV5-000 | 41109-ZV5-000 |

 BF35AM
 BF40B, B2, BX, A4, A/ A1, A2, AX, A3, AY
 BF45AM
 BF50A4, A/ A1, A2, AX, A3, AY



EJE HÉLICE

PROPELLER SHAFT

ASSE ELICA

ARBRE D'HELICE

| REF | OEM |
|------------------|---------------|
| REC41161-ZV5-000 | 41161-ZV5-000 |

 BF35AM
 BF40B, B2, BX, A4, A/ A1, A2, AX, A3, AY
 BF45AM
 BF50A4, A/ A1, A2, AX, A3, AY



RODAMIENTO PIÑÓN AVANTE

FORWARD GEAR BEARING

CUSCINETTO PIGNONE AVANTI

ROULEMENT DE PIGNON AVANT

| REF | OEM |
|---------------|---------------|
| REC31-30894A1 | 91051-ZW1-003 |

 BF75AT
 BT90AT



| REF | OEM |
|--------------|---------------|
| REC31-30895T | 91057-ZW1-003 |

 BF75AT
 BT90AT



RODAMIENTO DIÁBOLO

CARRIER BEARING

CUSCINETTO DIAVOLO

ROULEMENT DE DIABOLO

| REF | OEM |
|-----------|---------------|
| REC387247 | 91053-ZW1-003 |

 BF75AT
 BF90AT



ARANDELA DE CIERRE

TAB WASHER

RONDELLA CHIUSURA

RONDELLE FREIN

| REF | OEM |
|------------------|---------------|
| REC90508-ZW1-003 | 90508-ZW1-003 |

 BF75AT
 BF90AT



SISTEMA DE PROPULSIÓN PROPULSION SYSTEM

SISTEMA DI PROPULSIONE SYSTEME DE PROPULSION

HÉLICES ALUMINIO
E INOXIDABLE
DE 3 Y 4 PALAS

3 & 4 BLADE
ALUMINIUM & SS
PROPELLERS

ELICHE ALLUMINIO
E INOX DA 3 E 4
PALE

HELICE ALUMINIUM
ET INOX 3 ET 4
PALES

CÓDIGO DE REFERENCIAS

PART NO. CODING SYSTEM

SISTEMA DI CODICE

CODAGE DES REFERENCES

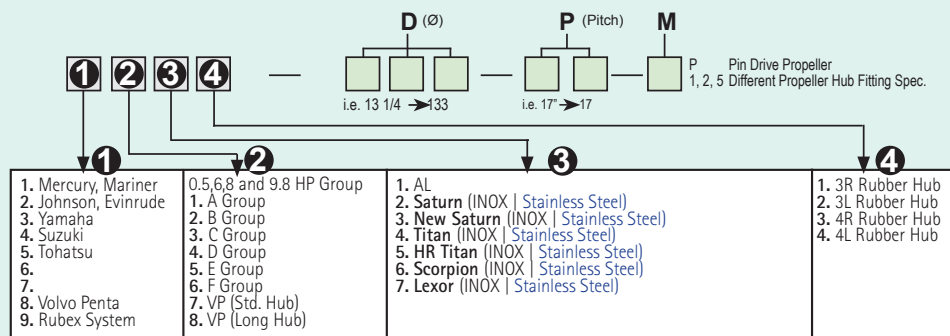

SOLAS

AMITA 3

SOLAS

Hélice de aluminio con núcleo de goma de gran resistencia.

Aluminum propeller with heavy duty rubber hub.

Eliche di alluminio con mozzi in gomma ad alta resistenza.

Hélice en aluminium avec moyeu en caoutchouc



AMITA 4

SOLAS

Hélices de aluminio con núcleo de goma de gran resistencia. Van muy suaves a poca velocidad y hace el barco muy manejable con la mar picada.

Aluminum propeller with heavy duty rubber hub. Smoother low speed makes the offshore boating activity much easier.

Eliche di alluminio con mozzo in gomma ad alta resistenza. Molto morbido a bassa velocità e rende la barca molto maneggevole con mare cattivo.

Hélice en aluminium avec moyeu en caoutchouc. Permet d'aller doucement à basse vitesse et rende le bateau très maniable lorsque la mer est agitée



TITAN

SOLAS

Hélices de acero inox. Diseño de pala grande para un área más grande. Gran capacidad de transporte de carga. Excelente economía de combustible.

Stainless steel propeller. High camber blade and large blade area design. Great load carrying capability. Excellent fuel economy.

Eliche in acciaio inossidabile. Ampia capacità di carico. Eccellente riduzione consumo del carburante.

Hélice en acier inoxydable. Lame à carrossage élevé et conception à grande surface de lame. Grande capacité de charge. Excellente économie de carburant.



NEW SATURN

SOLAS

Hélices de acero inoxidable. Ofrece buena aceleración y rendimiento. Tamaño más pequeño que ofrece un diámetro extragrande.

Stainless steel propeller. Offers good acceleration & all-round performance. Smaller pitch sizes offered in extra large diameter with increased blade area.

Eliche di acciaio inox. Buona accelerazione. Piccole dimensioni che offre un più grande diametro.

Hélice inox, offrant de bonnes accélérations et performances. Taille de pas réduite pour les modèles de grands diamètres avec une surface de pale plus importante.

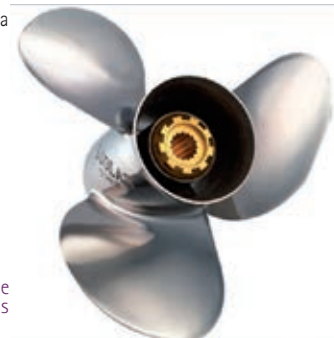

HR TITAN 3 PROP

SOLAS

Hélice de acero inoxidable. Alto rendimiento para cascos de alta velocidad. La inclinación de la hoja proporciona un excelente elevación de proa y aceleración. El diseño de copa grande aumenta la mordida y reduce el deslizamiento.

Stainless steel propeller. Performance prop for high speed planning hulls. High rake blade design provides excellent bow lift and acceleration. Heavy cup design increases bite and reduces slip.

Eliche in acciaio inox. Alte prestazioni per scafi ad alta velocità. Il passo della pala fornisce un'eccellente spinta e accelerazione. Il disegno aumenta le prestazioni.

Hélice en acier inoxydable. Hélice de performance pour les coques de planification à grande vitesse. La conception de la lame à haut râteau offre une excellente portance et accélération de l'arc. La conception lourde de la tasse augmente la morsure et réduit le glissement.



**GUÍA DE HÉLICES
CON NÚCLEO INTEGRADO**

**PROPELLERS APPLICATION
WITH RUBBER HUB**

**GUIDA ELICHE
CON MOZZO**

**GUIDE DES HELICES ET
MOYEURS**

| | R.O. OEM | AL | | | | | INOX STAINLESS STEEL | | | | | |
|---------------|-----------------|----|---|---|--------------------------------------|------------------|-------------------------|---------|-----------------|----------------|----------------|----------------|
| | | A | B | D | P | R | AMITA 3 | | AMITA 4 | NEW SATURN | TITAN | HR TITAN 3 |
| | | | | | | | | | | | | |
| BF2 Series | 58130-ZV0-841ZB | | | 3 | 7 ^{1/4} | 6 | R | Plastic | SOL6001-073-06P | | | |
| BF4 | | | | 3 | 7 ^{7/8} | 6 ^{3/4} | R | | SOL6011-079-06P | | | |
| BF5 | | | | | | 7 ^{1/2} | | | SOL6011-079-07P | | | |
| | | | | | 9 ^{1/4} | 7 | | | SOL3111-093-07 | | | |
| 8 (2001+) | 58130-ZV4-703ZB | | | | 9 ^{1/2} | 8 ^{5/8} | | | SOL3111-093-08 | | | |
| 9.9 (1988+) | 58130-ZV4-030ZB | 8 | 3 | | 9 ^{1/2} | 9 ^{1/2} | R | | SOL3111-093-09 | | | |
| 15 (1988+) | | | | | 9 ^{1/4} | 10 | | | SOL3111-093-10 | | | |
| 20 (2003+) | | | | | 9 ^{1/4} | 11 | | | SOL3111-093-11 | | | |
| | 58130-ZV7-850ZA | | | | 9 ^{3/4} | 9 ^{7/8} | | | SOL5211-099-09 | | | |
| | | | | | | | | | SOL5211-099-10 | | | |
| 25 | 58130-ZV7-000ZA | 10 | 3 | | 9 ^{1/4} | 12 | R | | SOL5211-099-11 | | | |
| 30 | | | | | | | | | SOL5211-099-12 | | | |
| | | | | | | | | | SOL5211-099-13 | | | |
| | 58130-ZV5-860ZA | | | | 11 ^{3/4} | 10 | | | SOL3311-121-09 | | | |
| | | | | | | | | | SOL3311-116-11 | | | |
| 35 (1991+) | 58130-ZV5-850ZA | | | | 11 ^{1/2} | 12 | | | SOL3311-114-12 | | | |
| 40 (1995+) | 58130-ZV5-000ZA | | | | 11 ^{1/4} | 13 | | | SOL3311-111-13 | | | |
| 45 (1991-94) | 58130-ZV5-870ZA | 13 | 3 | | 11 ^{1/2} | 14 | R | | SOL3311-111-14 | | | |
| BF40EFI | | | | | | | | | SOL3311-110-15 | | | |
| BF50EFI | | | | | 11 | 16 | | | SOL3311-110-16 | | | |
| BF60EFI | | | | | 11 | 17 | | | SOL3311-110-17 | | | |
| 50 (1995+) | | | | | | | | | | | | |
| | 58130-ZW1-W01ZA | | | | 14 | 11 | R | | SOL6411-140-11 | | SOL6431-140-11 | |
| | 58130-ZW1-W11ZA | | | | 13.75-13.25 | 13 | R | | SOL6411-138-13 | SOL6413-133-13 | SOL6431-138-13 | |
| | | | | | 13.5 | 14 | R | | SOL6411-135-14 | | | |
| | | | | | 13.5-13 | 15 | R | | SOL6411-135-15 | SOL6413-130-15 | SOL6431-135-15 | |
| | 58130-ZW1-W31ZA | | | | 13.5 | 15 | L | | SOL6412-135-15 | | | |
| | | | | | 13.25-12.75 | 17 | R | | SOL6411-133-17 | SOL6413-128-17 | SOL6431-133-17 | |
| 75 (1995+) | 58130-ZW1-W61ZA | | | | 13.25 | 17 | L | | SOL6412-133-17 | | | |
| 90 (1995+) | 58130-ZW1-W41ZA | 15 | 3 | | 13-12.5 | 19 | R | | SOL6411-130-19 | SOL6413-125-19 | SOL6431-130-19 | |
| 115 (1998-09) | | | | | 13-12.5 | 21 | R | | SOL6411-130-21 | SOL6413-125-21 | SOL6431-130-21 | |
| 130 (1998-09) | | | | | | | | | | | | |
| BFP60A | 08M60-ZW7-A40 | | | | 14 ^{1/2} | 15 | R | | | | SOL1531-145-15 | |
| | | | | | 14 ^{1/4} | 17 | R | | | | SOL1531-143-17 | |
| | 08M60-ZW7-A00 | | | | 14 | 19 | R | | | | SOL1531-140-19 | |
| | 08M60-ZW7-A10 | | | | 14 | 21 | R | | | | SOL1531-140-21 | |
| | 08M60-ZW7-A20 | | | | 14 | 23 | R | | | | SOL1531-140-23 | |
| | 08M60-ZW7-A30 | | | | 14 | 25 | R | | | | SOL1531-140-25 | |
| | | | | | 15-14.75 | 15 | R | | SOL1511-150-15 | SOL1513-148-15 | | |
| | | | | | 15 | 15 | L | | SOL1512-150-15 | | SOL1532-145-15 | |
| | | | | | 14.8-14.5 | 17 | R | | SOL1511-148-17 | SOL1513-145-17 | | |
| | | | | | 14.8 | 17 | L | | SOL1512-148-17 | | SOL1532-143-17 | |
| | | | | | 14.5-14.25 | 19 | R | | SOL1511-145-19 | SOL1513-143-19 | | |
| | | | | | 14.5 | 19 | L | | SOL1512-145-19 | | SOL1532-140-19 | |
| | | | | | 14 | 21 | R | | | SOL1513-140-21 | | |
| | | | | | 14 | 23 | R | | | SOL1513-140-23 | | |
| | | | | | 14.3 | 21 | R | | SOL1511-143-21 | | | |
| | | | | | 14.3 | 21 | L | | SOL1512-143-21 | | SOL1532-140-21 | |
| | | | | | 14.2 | 23 | R | | SOL1511-142-23 | | | |
| | | | | | 14.2 | 23 | L | | SOL1512-142-23 | | SOL1532-140-23 | |
| | | 15 | 3 | | 15 ^{1/2} -15 ^{3/4} | 15 | R | | | | SOL1571-158-15 | |
| | | | | | 15 ^{1/2} -15 ^{3/4} | 15 | L | | | | SOL1542-155-15 | SOL1572-158-15 |
| | | | | | 15 ^{1/4} -15 ^{1/2} | 17 | R | | | | SOL1571-155-17 | |
| | | | | | 15 ^{1/4} -15 ^{1/2} | 17 | L | | | | SOL1572-155-17 | |
| | | | | | 15-15 ^{1/4} | 19 | R | | | | SOL1571-153-19 | |
| | | | | | 15-15 ^{1/4} | 19 | L | | | | SOL1572-153-19 | |
| | | | | | 14 ^{3/4} -15 | 21 | R | | | | SOL1571-150-21 | |
| | | | | | 14 ^{3/4} -15 | 21 | L | | | | SOL1572-150-21 | |
| | | | | | 14 ^{1/2} -14 ^{3/4} | 23 | R | | | | SOL1571-148-23 | |
| | | | | | 14 ^{1/2} -14 ^{3/4} | 23 | L | | | | SOL1572-148-23 | |
| | | | | | 14 ^{1/2} | 25 | R | | | | SOL1571-145-25 | |

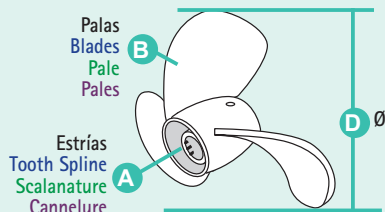



- P** Paso
Pitch
Passo
Pas
- R** Rotación L (izquierda) R (derecha)
Rotation L (left) R (Right)
Rotazione L (SX) R (DX)
Rotation L (gauche) R (droit)

NÚCLEO INTERCAMBIABLE INTERCHANGEABLE HUB

MOZZO INTERCAMBIABILE

MOYEU INTERCHANGEABLE

|  | A | REF |  |
|---|----|------------|---|
| BF 35/45 (1991-94) | 13 | SOLRBX-113 | C |
| BF 40/50/50A (1995+) | 13 | SOLRBX-102 | D |
| 75-90 HP (1995-98) | 13 | SOLRBX-107 | D |
| 75-90 HP (1999+) | 13 | SOLRBX-107 | D |
| 115-130HP (1998+) | 15 | SOLRBX-107 | D |
| 115-130HP (1998+) | 15 | SOLRBX-107 | E |
| BF135, 150, 200, 225HP (2003+) | 15 | SOLRBX-107 | E |
| BF250 | | | |



RUBEX

HÉLICES PARA NÚCLEO INTERCAMBIABLE

PROPELLERS FOR INTERCHANGEABLE HUB

ELICHE PER MOZZO INTERCAMBIABILE

HELICES AVEC MOYEU INTERCHANGEABLE

|  | B | D | P | R | AL |
|---|----|-------|----------------|---|----------------|
| C 30-75 HP | 3 | 12.1 | 9 | R | SOL9311-121-09 |
| | | 12 | 10 | R | SOL9311-120-10 |
| | | 11.6 | 11 | R | SOL9311-116-11 |
| | | 11.4 | 12 | R | SOL9311-114-12 |
| | | 11.1 | 13 | R | SOL9311-111-13 |
| | | 11.1 | 14 | R | SOL9311-111-14 |
| D 40-140 HP | 3 | 11 | 15 | R | SOL9311-110-15 |
| | | 14 | 9 | R | SOL9411-140-09 |
| | | 14 | 11 | R | SOL9411-140-11 |
| | | 13.75 | 13 | R | SOL9411-138-13 |
| | | 13.50 | 15 | R | SOL9411-135-15 |
| | | 13.25 | 17 | R | SOL9411-133-17 |
| E 135-350 HP | 3 | 13.2 | 19 | R | SOL9411-132-19 |
| | | 13.2 | 21 | R | SOL9411-132-21 |
| | | 15.5 | 11 | R | SOL9511-155-11 |
| | | 15.3 | 13 | R | SOL9511-153-13 |
| | | 16 | 13 | R | SOL9511-160-13 |
| | | 15 | 15 | R | SOL9511-150-15 |
| | | 15 | 15 | L | SOL9512-150-15 |
| | | 14.8 | 17 | R | SOL9511-148-17 |
| | | 14.8 | 17 | L | SOL9512-148-17 |
| | | 14.5 | 19 | R | SOL9511-145-19 |
| 14.5 | 19 | L | SOL9512-145-19 | | |
| 14.3 | 21 | R | SOL9511-143-21 | | |
| 14.3 | 21 | L | SOL9512-143-21 | | |

|  | B | D | P | R | INOX STAINLESS STEEL |
|---|----|--------|----------------|---|-------------------------|
| C 30-75 HP | 3 | 11 5/8 | 11 | R | SOL9331-116-11 |
| | | 11 3/8 | 12 | R | SOL9331-114-12 |
| | | 11 1/8 | 13 | R | SOL9331-111-13 |
| | | 11 1/8 | 14 | R | SOL9331-111-14 |
| | | 11 | 15 | R | SOL9331-110-15 |
| D 40-140 HP | 3 | 13 3/4 | 13 | R | SOL9431-138-13 |
| | | 13 3/4 | 13 | L | SOL9432-138-13 |
| | | 13 1/2 | 15 | R | SOL9431-135-15 |
| | | 13 1/2 | 15 | L | SOL9432-135-15 |
| | | 13 1/4 | 17 | R | SOL9431-133-17 |
| | | 13 1/4 | 17 | L | SOL9432-133-17 |
| | | 13 | 19 | R | SOL9431-130-19 |
| E 90-140 HP | 3 | 13 | 19 | L | SOL9432-130-19 |
| | | 13 | 21 | R | SOL9431-130-21 |
| | | 14 1/2 | 15 | R | SOL9531-145-15 |
| | | 14 1/2 | 15 | L | SOL9532-145-15 |
| | | 14 1/4 | 17 | R | SOL9531-143-17 |
| | | 14 1/4 | 17 | L | SOL9532-143-17 |
| | | 14 | 19 | R | SOL9531-140-19 |
| | | 14 | 19 | L | SOL9532-140-19 |
| | | 14 | 21 | R | SOL9531-140-21 |
| | | 14 | 21 | L | SOL9532-140-21 |
| E 135-350 HP | 3 | 14 | 23 | R | SOL9531-140-23 |
| | | 14 | 23 | L | SOL9532-140-23 |
| | | 15 3/4 | 15 | R | SOL9571-158-15 |
| | | 15 3/4 | 15 | L | SOL9572-158-15 |
| | | 15 1/2 | 17 | R | SOL9571-155-17 |
| | | 15 1/2 | 17 | L | SOL9572-155-17 |
| | | 15 1/4 | 19 | R | SOL9571-153-19 |
| | | 15 1/4 | 19 | L | SOL9572-153-19 |
| | | 15 | 21 | R | SOL9571-150-21 |
| | | 15 | 21 | L | SOL9572-150-21 |
| 14 3/4 | 23 | R | SOL9571-148-23 | | |
| 14 3/4 | 23 | L | SOL9572-148-23 | | |
| 14 1/2 | 25 | R | SOL9571-145-25 | | |
| 14 1/2 | 25 | L | SOL9572-145-25 | | |

RUBEX



Núcleo intercambiable (no incluido).
Interchangeable hub (not included).
Mozzo intercambiabile (non incluso).
Moyeu interchangeable (non inclus)



REF --> RO / OEM

| REF | R.O. / OEM | |
|-------------------|-----------------|-------------|
| C | | |
| CEF500301 | 19210-ZW1-303 | 568 |
| CEF500328 | 19210-ZV4-013 | 568 |
| CEF500337 | 19210-ZW1-B04 | 568 |
| CEF500338 | 19210-ZV5-003 | 568 |
| CEF500339 | 19210-ZV7-003 | 568 |
| CEF500343 | 19210-ZV4-651 | 568 |
| CEF500347 | 19210-ZW9-013 | 568 |
| CEF500348 | 19210-ZW9-A32 | 568 |
| CEF500391 | 19210-ZY3-003 | 568 |
| CM06411-ZV5-000 | 06411-ZV5-000 | 571 |
| CM06411-ZV5-000 | 06411-ZV5-020 | 571 |
| CM06411-ZV5-000A | 06411-ZV5-000 | 571 |
| CM06411-ZV5-000A | 06411-ZV5-020 | 571 |
| CM06411-ZW1-000 | 06411-ZW1-000 | 571 |
| CM06411-ZW1-000 | 06411-ZW1-020 | 571 |
| CM06411-ZW1-000A | 06411-ZW1-000 | 571 |
| CM06411-ZW1-000A | 06411-ZW1-020 | 571 |
| CM31640 | 06412-ZV1-000 | 571 |
| CM31640 | 41107ZV1003 | 571 |
| CM31640A | 06412-ZV1-000 | 571 |
| CM31640A | 41107ZV1003 | 571 |
| CM41106-ZW9-000A | 41106-ZW9-000 | 572 |
| CM41106-ZW9-000A | 41106ZV909000 | 572 |
| CM41106-ZW9-09000 | 41106-ZW9-000 | 571 |
| CM41106-ZW9-09000 | 41106ZV909000 | 571 |
| CM41106-ZW9-09000 | 41106-ZW9-090 | 545 |
| CM41107-ZV500 | 06412-ZV5-000 | 571 |
| CM41107-ZV500 | 41107ZV500 | 571 |
| CM41107-ZV500A | 06412-ZV5-000 | 572 |
| CM41107-ZV500A | 41107ZV500 | 572 |
| CM41107-ZV500A | 41107-ZV5-000 | 545 |
| CM41107-ZW1-B01 | 41107ZV1-B01 | 571 |
| CM41107-ZW1-B01A | 41107ZV1-B01 | 571 |
| CM41109-ZW1-B00 | 41109-ZW1-B00 | 571 |
| CM41109-ZW1-B00A | 41109-ZW1-B00 | 571 |
| CM664-45371-01 | 06412-ZV5-000 | 571 |
| CM664-45371-01A | 06412-ZV5-000 | 571 |
| CM6E0-45251-11 | 2155-ZV5-000 | 571 |
| CM6E0-45251-11A | 2155-ZV5-000 | 571 |
| CM826134 | 12155-ZV5-000 | 571 |
| CM826134 | 41109-ZW1-003 | 571 |
| CM826134A | 12155-ZV5-000 | 571 |
| CM826134A | 41109-ZW1-003 | 571 |
| CMHBF35225KITA | | 546-571 |
| CMHBF35225KITM | | 571 |
| CMHBF4050KITA | | 545-546-571 |
| CMHBF4050KITM | | 571 |
| CMHBF75115KITA | | 546-571 |
| CMHBF75115KITM | | 571 |
| CHACJ14 | | 559 |
| CHAP10Y | | 559 |
| CHAP8Y | | 559 |
| CHAPROSU | | 559 |
| CHARA6HC | | 559 |
| CHARA8HC | | 559 |
| CHARC9MC4 | | 559 |
| CHARN11YC4 | | 559 |
| G | | |
| GS11290 | | 561 |
| GS11291 | | 561 |
| GS11292 | | 561 |
| GS11294 | | 561 |
| GS30435 | | 552 |
| GS31001 | | 552 |
| GS31002 | | 552 |
| GS31030 | 17660-ZV5-902 | 548 |
| GS31031 | 17660-ZV5-A00 | 548 |
| GS31031 | 17660-ZW9-003 | 548 |
| GS31032 | 116977-ZV5-900 | 549 |
| GS31033 | 116977-ZV5-A00 | 549 |
| GS31034 | 17650-921-003ZB | 548 |
| GS31064 | | 549 |
| GS31065 | | 552 |
| GS31066 | | 552 |
| GS31067 | | 552 |
| GS31068 | | 548 |
| GS31069 | | 548 |
| GS31090 | | 547 |
| GS31095 | | 547 |
| GS31096 | | 547 |
| GS31097 | | 547 |
| GS31099 | | 547 |
| GS31155 | | 552 |
| GS31156 | | 552 |
| GS31157 | | 552 |
| GS31166 | | 552 |
| GS31183 | | 547 |
| GS31187 | | 547 |
| GS31189 | | 547 |
| GS35031 | | 547 |
| GS35032 | | 547 |
| L | | |
| LENS3213 | 17670-ZW1-801AH | 550-551 |
| LENS3227 | | 550 |
| LENS3240 | 17670-ZW1-030GH | 551 |
| N | | |
| NGKBMR4A | | 559 |
| NGKBPR5ES | 98079-55846 | 545-559 |
| NGKCR5EH-9 | 98059-55916 | 545-559 |
| NGKCR5HSB | | 559 |
| NGKDR4HS | | 559 |

| REF | R.O. / OEM | |
|------------------|-----------------|-----------------|
| NGKDR5HS | 98066-55716 | 559 |
| NGKDR6HS | | 545-559 |
| NGKDR7EA | 98069-5771P | 545-546-559 |
| NGKDR7EB | 98069-5777P | 546 |
| NGKIZFR6K-11E | 31916-ZX2-003 | 559 |
| NGKIZFR6K11 | 31916-ZY3-003 | 546-559 |
| NGKLMAR6C-9 | 31908-ZZ3-003 | 546-559 |
| NGKZFR7F | | 546-559 |
| P | | |
| PAF15-04000003 | 90507-921-000 | 545-546 |
| PAF15-07000031 | 19300-881-741 | 566 |
| PAF15-07000031 | 19300-921-003 | 566 |
| PAF15-07000031 | 19300-ZW9-003 | 566 |
| PAF15-07000031 | 19300-ZW9-003 | 545-546-566-567 |
| PAF4-04000030 | | 548 |
| PAF4-05000010 | | 548 |
| PAF40-0701000E1 | | 550 |
| PAGB/T91-2.5X30 | 90758-ZV1-000 | 545-546 |
| PH130-0054 | 31200-ZV5-003 | 560 |
| PH130-0054 | 31200-ZV5-013 | 560 |
| PH130-0064 | 31200-ZW1-004 | 560 |
| PH130-0065 | 31200-ZW5-003 | 560 |
| PH130-0070 | 31200-ZY3-003 | 560 |
| PH130-0070 | 31200-ZY3A-0034 | 560 |
| PH200-T021 | 36120-ZV5-821 | 562 |
| PH200-T046 | 36120-ZV5-822 | 562 |
| PH200-WH01 | | 562 |
| PRE3300C05 | 24911-ZW7-U01 | 565 |
| PRE3300C06 | 24912-ZW7-U01 | 565 |
| PRE3300C07 | 24913-ZW7-U01 | 565 |
| PRE3300C08 | 24914-ZW7-U01 | 565 |
| PRE3300C09 | 24915-ZW7-U01 | 565 |
| PRE3300C10 | 24916-ZW7-U01 | 565 |
| PRE3300C11 | 24917-ZW7-U01 | 565 |
| PRE3300C12 | 24918-ZW7-U01 | 565 |
| PRE3300C13 | 24919-ZW7-U01 | 565 |
| PRE3300C14 | 24920-ZW7-U01 | 565 |
| PRE3300C15 | 24921-ZW7-U01 | 565 |
| PRE3300C16 | 24922-ZW7-U01 | 565 |
| PRE3300C17 | 24923-ZW7-U01 | 565 |
| PRE3300C18 | 24924-ZW7-U01 | 565 |
| PRE3300C19 | 24925-ZW7-U01 | 565 |
| PRE3300C20 | 24926-ZW7-U01 | 565 |
| PRE3300C21 | 24927-ZW7-U01 | 565 |
| PRE3300C22 | 24928-ZW7-U01 | 565 |
| PRE3300C23 | 24929-ZW7-U01 | 565 |
| PRE3300C24 | 24930-ZW7-U01 | 565 |
| PRE3300C25 | 24931-ZW7-U01 | 565 |
| PRE3300C26 | 24932-ZW7-U01 | 565 |
| PRE3300C27 | 24933-ZW7-U01 | 565 |
| PRE3300C28 | 24934-ZW7-U01 | 565 |
| PRE3300C29 | 24935-ZW7-U01 | 565 |
| PRE3300C30 | 24936-ZW7-U01 | 565 |
| PRE3300C31 | 24937-ZW7-U01 | 565 |
| PRE3300C32 | 24938-ZW7-U01 | 565 |
| R | | |
| RAC025-RAC-02 | 06176-ZW3-801AH | 553 |
| RAC120R-RAC-01 | 06178-ZW1-030GH | 551 |
| RAC23289-10 | | 550 |
| RAC23299-10 | | 550 |
| RAC320R-INOX-01 | 06177-ZW1-801AH | 551 |
| RAC320R-INOX-02 | | 551 |
| RAC320R-RAC-01 | | 550-551 |
| RAC320R-RAC-02 | | 551 |
| RAC320R-RAC-03 | 06177-ZW1-801AH | 550-551 |
| RAC490R-RAC-01 | | 550 |
| RACPF5510 | | 549 |
| RACRK22628 | | 552 |
| RACS2502 | 17670-ZW3-801AH | 553 |
| RACS3213 | 17670-ZW1-801AH | 550-551 |
| RACS3220UL | | 551 |
| RACS3227 | | 550 |
| RACS3240 | 17670-ZW1-030GH | 551 |
| REC004 | | 559 |
| REC06160-ZV4-U11 | 06160-ZV4-U11 | 556 |
| REC06164-PCA-000 | 06164-PCA-000 | 555 |
| REC06192-881-C00 | 06192-881-C00 | 570 |
| REC06192-ZV1-000 | 06192-ZW1-000 | 546-570 |
| REC06192-ZV1-000 | 06192-ZV1-000 | 570 |
| REC06192-ZV1-305 | 06192-ZV1-305 | 546-570 |
| REC06192-ZV1-305 | 06192-ZW1-305 | 570 |
| REC06192-ZV1-C00 | 06192-ZV1-C00 | 545-570 |
| REC06192-ZV4-000 | 06192-ZV4-000 | 545-570 |
| REC06192-ZV4-000 | 19210-ZV4-651 | 570 |
| REC06192-ZV5-003 | 06192-ZV5-003 | 545-546-570 |
| REC06192-ZV7-000 | 06192-ZV7-000 | 545-570 |
| REC06192-ZV7-000 | 06192-ZW2-000 | 570 |
| REC06192-ZW9-A30 | 06192-ZW9-A30 | 545-570 |
| REC06192-ZY3-000 | 06192-ZX2-000 | 570 |
| REC06192-ZY3-000 | 06192-ZY3-000 | 570 |
| REC06192-ZY3-000 | 06192-ZY3-000 | 546 |
| REC06192-ZY6-000 | 06192-ZY6-000 | 546-570 |
| REC06193-ZV5-020 | 06193-ZV5-000 | 570 |
| REC06193-ZV5-020 | 06193-ZV5-010 | 570 |

| REF | R.O. / OEM | |
|--------------------|-------------------|-------------|
| REC06193-ZV5-020 | 06193-ZV5-020 | 570 |
| REC06211-ZV1-505 | 06211-ZV1-505 | 545 |
| REC06211-ZV4-505 | 06211-ZV4-505 | 545 |
| REC06211-ZV5-505 | 06211-ZV5-505 | 545 |
| REC06211-ZV7-505 | 06211-ZV7-505 | 545 |
| REC06211-ZW0-505 | 06211-ZW0-505 | 546 |
| REC06211-ZW5-505 | 06211-ZW5-505 | 546 |
| REC06211-ZW9-505 | 06211-ZW9-505 | 545 |
| REC06211-ZY0-505 | 06211-ZY0-505 | 545 |
| REC06211-ZY2-506 | 06211-ZY2-506 | 546 |
| REC06211-ZY5-505 | 06211-ZY5-505 | 546 |
| REC06211-ZY9-505 | 06211-ZY9-505 | 546 |
| REC06211-ZZ3-506 | 06211-ZZ3-506 | 546 |
| REC06211-ZZ5-505 | 06211-ZZ5-505 | 546 |
| REC06240-ZW5-U40 | 06240-ZW5-U40 | 564 |
| REC06240-ZW5-U40 | 06240-ZW5-U001 | 564 |
| REC06240-ZW5-U60 | 06240-ZW5-U60 | 564 |
| REC09401-11425 | | 548 |
| REC09401-11425BULK | | 548 |
| REC09401-11425BULK | | 548 |
| REC10W30U3 | 08207-10W30M-FC-W | 553 |
| REC10W30U6 | 08209-10W30M-FC-W | 553 |
| REC10W40U3 | | 553 |
| REC10W40U6 | | 553 |
| REC12-191833 | 12-191833 | 545-546-574 |
| REC12209-6B4-681 | 12209-GB4-681 | 575 |
| REC12251-ZV5-003 | 12251-ZW4-H01 | 574 |
| REC12251-ZV5-003 | 12251-ZV5-000 | 573 |
| REC12251-ZV5-003 | 12251-ZV5-003 | 573 |
| REC12251-ZV7-004 | 12251-ZV7-004 | 573 |
| REC12251-ZW1-014 | 12251-ZW1-004 | 573 |
| REC12251-ZW1-014 | 12251-ZW1-014 | 573 |
| REC12251-ZW5-023 | 12251-ZW5-003 | 573 |
| REC12251-ZW5-023 | 12251-ZW5-023 | 573 |
| REC14400-ZV5-014 | 14400-ZV5-004 | 574 |
| REC14400-ZV5-014 | 14400-ZV5-014 | 574 |
| REC14400-ZZ3-004 | 14400-ZZ3-004 | 574 |
| REC15112-ZW5-003 | 15112-ZW5-003 | 573 |
| REC15400-PLM-A01PE | 15400-PH1-F03 | 554 |
| REC15400-PLM-A01PE | 15400-PLM-A01PE | 554 |
| REC15400-PLM-A01PE | 15400-POH-305 | 554 |
| REC15400-PLM-A01PE | 15400-POH-305PE | 554 |
| REC15400-PLM-A01PE | 15400-RTA-003 | 554 |
| REC15400-PLM-A01PE | 15400-RTA-004 | 554 |
| REC15400-PLM-A01PE | 15400-ZJI-004 | 546-554 |
| REC15400-RBA-F01 | 15400-RBA-F01 | 546-554 |
| REC16010-ST5-993 | 16900-ST5-993 | 553 |
| REC16010-ZV4-005 | 06160-ZV4-U11 | 556 |
| REC16010-ZV4-005 | 16010-ZV4-005 | 556 |
| REC16010-ZV4-005 | 16010-ZV4-005 | 556 |
| REC16010-ZW9-003 | 16010-ZW9-003 | 556 |
| REC16011-881-741 | 16011-881-741 | 555 |
| REC16011-ZV4-005 | 16011-ZV4-005 | 555 |
| REC16201-881-850 | 16201-881-850 | 575 |
| REC16221-ZV4-610 | 16221-ZV4-610 | 575 |
| REC16221-ZW1-000 | 16221-ZW1-000 | 575 |
| REC16221-ZW9-000 | 16221-ZW9-000 | 576 |
| REC16700-ZW1-004 | 16700-ZW1-004 | 555 |
| REC16700-ZW1-004 | 16700-ZV5-003 | 555 |
| REC16735-ZW5-003 | 16735-ZW5-003 | 555 |
| REC16735-ZW5-003 | 16735-ZY3-004 | 555 |
| REC16900-SA5-004 | 16900-SA5-004 | 545-546-552 |
| REC16900-SR3-004 | 16900-SR3-004 | 546-552 |
| REC16901-ZY3-003 | 16901-ZY3-003 | 553 |
| REC16901-ZY3-003 | 16911-ZY3-003 | 553 |
| REC16910-GB2-005 | 16900-GB2-005 | 545-552 |
| REC16910-ZV4-015 | 16910-ZV4-015 | 545-552 |
| REC16911-ZY3-010 | 16911-ZY3-010 | 546-553 |
| REC16911-ZZ5-003 | 16911-ZZ5-003 | 546-553 |
| REC17105-ZY3-004 | 17105-ZY3-004 | 575 |
| REC17105-ZY6-000 | 17105-ZY6-000 | 575 |
| REC17109-ZY3-004 | 17109-ZY3-004 | 575 |
| REC17109-ZY6-000 | 17109-ZY6-000 | 575 |
| REC17151-ZY5-000 | 17151-ZY5-000 | 575 |
| REC17384-ZW4-000 | 17384-ZW4-000 | 574 |
| REC17710-ZW9-033 | 17710-ZW9-023 | 548 |
| REC17710-ZW9-033 | 17710-ZW9-033 | 548 |
| REC18-6865 | | 563 |
| REC18-7053 | | 556 |
| REC18-8362-1 | | 578 |
| REC18-8363 | | 578 |
| REC18-8365 | | 578 |
| REC18-8366 | | 578 |
| REC19210-881-003 | 19210-881-003 | 568 |
| REC19210-881-003 | 19210-881-A01 | 568 |
| REC19210-881-003 | 19210-881-A02 | 568 |
| REC19210-881-003 | 19210-881-A02 | 568 |
| REC19210-ZV4-013 | 19210-ZV4-013 | 567-568 |
| REC19210-ZV4-651 | 19210-ZV4-651 | 567-568 |
| REC19210-ZV5-003 | 19210-ZV5-003 | 546-568-576 |
| REC19210-ZV7-003 | 19210-ZV7-003 | 567-568 |
| REC19210-ZW1-B02 | 19210-ZW1-B02 | 568 |
| REC19210-ZW1-B02 | 19210-ZW1-B03 | 568 |
| REC19210-ZW1-B02 | 19210-ZW1-B04 | 568 |

| REF | R.O. / OEM | |
|------------------|-----------------|-------------|
| REC19210-ZW9-013 | 19210-ZW9-013 | 545-568 |
| REC19210-ZW9-A32 | 19210-ZW9-A31 | 568 |
| REC19210-ZW9-A32 | 19210-ZW9-A32 | 568 |
| REC19210-ZW9-A32 | 19210-ZW9-A32 | 568 |
| REC19210-ZY3-003 | 19210-ZY3-003 | 568 |
| REC19210-ZY9-H01 | 19210-ZY9-H01 | 567-568 |
| REC19221-ZV5-000 | 19221-ZV5-000 | 576 |
| REC19223-ZV5-000 | 19223-ZV5-000 | 576 |
| REC19231-ZV5-000 | 19231-ZV5-000 | 576 |
| REC19232-881-850 | 19232-881-850 | 569 |
| REC19232-ZV1-A10 | 19232-ZV1-A10 | 569 |
| REC19232-ZV4-610 | 19232-ZV4-610 | 569 |
| REC19233-ZV5-000 | 19233-ZV5-000 | 569-576 |
| REC19234-881-850 | 19234-881-850 | 569 |
| REC19234-ZY3-000 | 19234-ZY3-000 | 569 |
| REC19242-ZV5-000 | 19242-ZV5-000 | 569-476 |
| REC19253-ZV5-000 | 19253-ZV5-000 | 576 |
| REC19300-881-761 | 19300-881-761 | 545-566-567 |
| REC19300-ZV5-043 | 19300-ZV5-003 | 566 |
| REC19300-ZV5-043 | 19300-ZV5-013 | 566 |
| REC19300-ZV5-043 | 19300-ZV5-023 | 566 |
| REC19300-ZV5-043 | 19300-ZV5-033 | 566 |
| REC19300-ZV5-043 | 19300-ZV5-043 | 566 |
| REC19300-ZV5-043 | 19300-ZV5-043 | 546-566-567 |
| REC22-8M0001721 | | 548 |
| REC23172-ZW1-013 | 23172-ZW1-013 | 573 |
| REC23172-ZW5-013 | 23172-ZW5-000 | 573 |
| REC23172-ZW5-013 | 23172-ZW5-013 | 573 |
| REC24800-ZZ5-A02 | 24800-ZZ5-A01 | 564 |
| REC24800-ZZ5-A02 | 24800-ZZ5-A02 | 564 |
| REC24800-ZZ5-A02 | 24800-ZZ5-A22 | 549 |
| REC24942 | 06177-ZX2-000HE | 549 |
| REC24950 | | 549 |
| REC24952 | 06177-ZX2-000HE | 549 |
| REC25-457101 | 91353-ZW1-003 | 577 |
| REC25-457101 | 91353-ZW1-003 | 578 |
| REC25000 | | 549 |
| REC25010 | | 549 |
| REC25020 | | 549 |
| REC25030 | | 549 |
| REC25W40U3 | | 553 |
| REC26-43035 | 91251-ZW1-003 | 577-578 |
| REC26-43036 | 91254-ZW1-003 | 577-578 |
| REC26-70081 | 91255-ZW1-003 | 578 |
| REC26-70081 | 91351-ZW1-003 | 577-578 |
| REC26-76868 | 91252-ZW1-003 | 577-578 |
| REC26-8164641 | 91253-ZW1-003 | 577-578 |
| REC27-430331 | 19234-ZW1-003 | 569-577 |
| REC27-430472 | 19242-ZW1-003 | 569-577 |
| REC27-8172771 | 19232-ZW1-003 | 569-577 |
| REC2TU3 | | 553 |
| REC2TU6 | | 553 |
| REC30520-PNA-007 | 30520-PNA-007 | 559 |
| REC30520-PWC-003 | 30520-PWC-S01 | 559 |
| REC30520-ZVL-003 | 30520-ZVL-003 | 559 |
| REC30520-ZX2-003 | 30520-ZX2-003 | 559 |
| REC30520-ZY3-003 | 30520-ZY3-003 | 559 |
| REC30530-P8F-A01 | 30530-P8F-A01 | 558 |
| REC30530-PNA-003 | 30530-PNA-003 | 558 |
| REC30530-RNA-A01 | 30530-RNA-A01 | 558 |
| REC30580-ZV4-013 | 30580-ZV4-023 | 559 |
| REC31-30894A1 | 91051-ZW1-003 | 577-579 |
| REC31-30895T | 91057-ZW1-003 | 577-579 |
| REC31200-ZW9-802 | 31200-ZW9-801 | 560 |
| REC31200-ZW9-802 | 31200-ZW9-802 | 560 |
| REC31200-ZY6-003 | 31200-ZY6-003 | 560 |
| REC31200-ZY6-003 | 31200-ZY9-003 | 560 |
| REC31200-ZY6-003 | 31200-ZY9A-0031 | 560 |
| REC31630-ZW5-003 | 31630-ZW5-003 | 562 |
| REC31630-ZY3-003 | 31630-ZY3-003 | 561 |
| REC31630-ZY6-003 | 31630-ZY6-003 | 561 |
| REC31630-ZY6-003 | 31630-ZY6-013 | 561 |
| REC31638-ZY3-003 | 31638-ZY3-003 | 561-562 |
| REC31638-ZY6-003 | 31638-ZY6-003 | 561-562 |
| REC35-802893Q | | 549 |
| REC35-802893Q01 | | 549 |
| REC35-822626Q03 | 15400-PFB-004 | 554 |
| REC35-822626Q03 | 15400-PFB-014 | 554 |
| REC35-822626Q03 | 15400-PFRB-007 | 554 |
| REC35-822626Q03 | 15400-PJ7-015 | 554 |
| REC35-822626Q03 | 15400-PM3-004 | 554 |
| REC35-822626Q03 | 15400-PM3-405 | 554 |
| REC35-822626Q03 | 15400-ZW4-003 | 554 |
| REC35-822626Q03 | 15400-ZW4-003 | 545-546-554 |
| REC35100-ZV5-013 | 35100-ZV5-013 | 565 |
| REC35340-ZZ5-D21 | 35340-ZZ5-D21 | 565 |
| REC35370-ZZ5-D02 | 35370-ZZ5-D02 | 565 |
| REC35370-ZW5-U02 | 35370-ZW5-U02 | 565 |
| REC35370-ZW5-U12 | 35370-ZW5-U12 | 565 |
| REC35655-ZY3-013 | 35655-ZY3-013 | 558 |
| REC35655-ZY9-003 | 35655-ZY9-003 | 558 |
| REC35668-ZY6-003 | 35668-ZY6-003 | 558 |
| REC36120-ZW4-H12 | 36120-ZW4-H12 | 563 |
| REC36120-ZY3-013 | 36120-ZY3-013 | 563 |
| REC36120-ZY6-013 | 36120-ZY6-013 | 563 |
| REC36120-ZY6-013 | 36120-ZY6-023 | 563 |
| REC36120-ZY9-003 | 36120-ZY9-003 | 563 |
| REC36120-ZY9-003 | 36120-ZY9-013 | 563 |
| REC36180-ZV5-033 | 36180-ZV5-003 | 561 |
| REC36180-ZV5-033 | 36180-ZV5-013 | 561 |
| REC36180-ZV5-033 | 36180-ZV5-023 | 561 |
| REC36180-ZV5-033 | 36180-ZV5-033 | 561 |

| REF | R.O. / OEM | |
|------------------|---------------------|-------------|
| REC37260-RNA-A01 | 37260-RNA-A01 | 557 |
| REC37500-PNB-003 | 37500-PNB-003 | 557 |
| REC37510-PNB-003 | 37510-PNB-003 | 557 |
| REC37830-PGK-A01 | 37830-PGK-A01 | 557 |
| REC37830-PNC-003 | 37830-PNC-003 | 557 |
| REC37830-RNA-A01 | 37830-RNA-A01 | 557 |
| REC37840-R70-A01 | 37840-R70-A01 | 557 |
| REC37880-PLC-004 | 37880-PLC-004 | 558 |
| REC38550-ZV5-823 | 38550-ZV5-823 | 563 |
| REC38550-ZY6-003 | 38550-ZY6-003 | 563 |
| REC38550-ZY6-003 | HZY-638550-003 | 563 |
| REC38580-ZY6-013 | 38580-ZY6-003/13 | 558 |
| REC38580-ZY9-023 | 38580-ZY9-023/13/03 | 558 |
| REC38580-ZY9-023 | HZY-38580-003 | 558 |
| REC387247 | 91053-ZW1-003 | 577-579 |
| REC40135 | | 552 |
| REC40145 | | 552 |
| REC40155 | | 552 |
| REC40165 | | 552 |
| REC40970 | | 561 |
| REC40990 | | 561 |
| REC41109-ZV5-000 | 41109-ZV5-000 | 579 |
| REC41161-ZV5-000 | 41161-ZV5-000 | 579 |
| REC47-43026Q02 | 19120-ZW1-303 | 577 |
| REC47-43026Q02 | 19210-ZW1-303 | 567-568 |
| REC47-43026Q06 | 19021-ZW1-003 | 570-577 |
| REC5GH-13440-00 | 15400-PFB-007 | 554 |
| REC5W40U3 | 08207-5W30M2 | 553 |
| REC5W40U6 | | 553 |
| REC650-24351-51 | | 548 |
| REC67F-12411-01 | 19300-ZX2-003 | 566-567 |
| REC6AH-12411-00 | 19300-ZY3-023 | 566-567 |
| REC6E5-12411-30 | 19300-ZY6-003 | 566-567 |
| REC6E5-24351-51 | | 548 |
| REC70720 | | 552 |
| REC80W90U3 | 08739-90W | 553 |
| REC80W90U6 | | 553 |
| REC8172761 | 19231-ZW1-003 | 569-577 |
| REC855686 | | 549 |
| REC90301-ZW1-003 | 90301-ZW1-003 | 577 |
| REC90508-ZW1-003 | 90508-ZW1-003 | 577-579 |
| REC90752-ZV4-650 | 90752-ZV4-650 | 569 |
| REC90752-ZV5-003 | 90752-ZV5-003 | 546-569-576 |
| REC90752-ZV7-000 | 90752-ZV7-000 | 569 |
| REC90752-ZW1-B02 | 90752-ZW1-003 | 577 |
| REC90752-ZW1-B02 | 90752-ZW1-B02 | 569 |
| REC90752-ZY3-003 | 90752-ZY3-003 | 569 |
| REC90794-46866 | | 551 |
| REC90794-46868 | | 551 |
| REC91251-ZV5-003 | 91251-ZV5-003 | 576 |
| REC91252-935-004 | 91252-935-004 | 570 |
| REC91252-ZV1-003 | 91252-ZV1-003 | 570 |
| REC91351-740-003 | 91351-740-003 | 576 |
| REC91353-ZV5-003 | 91353-ZV5-003 | 576 |
| REC91356-ZV5-000 | 91356-ZV5-000 | 576 |
| REC91555-ZV5-000 | 91555-ZV5-000 | 576 |
| RECOBRACKET | | 549 |
| RECOBELEMENT | | 550 |
| RECOBFILALU | | 550 |
| RECOBFILTER | | 550 |
| RECPIN4 | | 563 |
| RECPIN4.5 | | 563 |
| RECPIN6 | | 563 |
| RECTOOLTRIM1 | | 563 |
| RECTOOLTRIM2 | | 563 |
| RECTOOLTRIM3 | | 563 |
| RECTOOLTRIMKIT | | 563 |
| RECY5-225-15 | | 551 |
| RM06111-ZW1-020 | 06111-ZW1-000 | 574 |
| RM06111-ZW1-020 | 06111-ZW1-020 | 574 |
| RM061A1-ZV0-000 | 061A1-ZV0-000 | 574 |
| RM14400-921-024 | 14400-921-010 | 574 |
| RM14400-921-024 | 14400-921-024 | 574 |
| RM14400-ZV4-004 | 14400-ZV4-004 | 574 |
| RM14400-ZW1-004 | 14400-ZW1-004 | 574 |
| RM19211-ZV0-003 | 19211-ZV0-003 | 568 |
| RM35-802893Q | | 549 |
| RM92-858026QB1U6 | | 553 |
| RM92-858027QB1U3 | | 553 |
| RM92-8M0086220U6 | | 553 |
| RM92-8M0086221U3 | | 553 |
| SIE18-8013 | | 547 |
| SIE18-8015 | | 547 |
| SOL1511-142-23 | 58233-ZY3-A23H | 581 |
| SOL1511-143-21 | 58233-ZY3-A21H | 581 |
| SOL1511-145-19 | 58233-ZY3-A19H | 581 |
| SOL1511-148-17 | 58233-ZY3-A17H | 581 |
| SOL1511-150-15 | 58233-ZY3-A15H | 581 |
| SOL1512-142-23 | | 581 |
| SOL1512-143-21 | | 581 |
| SOL1512-145-19 | | 581 |
| SOL1512-148-17 | | 581 |
| SOL1512-150-15 | | 581 |
| SOL1513-140-21 | 58233-ZY3-A21H | 581 |
| SOL1513-140-23 | 58233-ZY3-A23H | 581 |
| SOL1513-143-19 | 58233-ZY3-A19H | 581 |
| SOL1513-145-17 | 58233-ZY3-A17H | 581 |
| SOL1513-148-15 | 58233-ZY3-A15H | 581 |
| SOL1531-140-19 | 08M60-ZW7-A00 | 581 |
| SOL1531-140-21 | 08M60-ZW7-A10 | 581 |

| REF | R.O. / OEM | |
|-----------------|-----------------|-----|
| SOL1531-140-23 | 08M60-ZW7-A20 | 581 |
| SOL1531-140-25 | 08M60-ZW7-A30 | 581 |
| SOL1531-143-17 | 58233-ZY3-A17H | 581 |
| SOL1531-145-15 | 08M60-ZW7-A40 | 581 |
| SOL1532-140-19 | 58233-ZY3-B19H | 581 |
| SOL1532-140-21 | | 581 |
| SOL1532-140-23 | | 581 |
| SOL1532-143-17 | 58233-ZY3-B17H | 581 |
| SOL1532-145-15 | 58233-ZY3-B15H | 581 |
| SOL1542-150-19 | | 581 |
| SOL1542-155-15 | | 581 |
| SOL1571-145-25 | | 581 |
| SOL1571-148-23 | | 581 |
| SOL1571-150-21 | | 581 |
| SOL1571-153-19 | | 581 |
| SOL1571-155-17 | | 581 |
| SOL1571-158-15 | | 581 |
| SOL1572-148-23 | | 581 |
| SOL1572-150-21 | | 581 |
| SOL1572-153-19 | | 581 |
| SOL1572-155-17 | | 581 |
| SOL1572-158-15 | | 581 |
| SOL3111-093-07 | | 581 |
| SOL3111-093-08 | 58130-ZV4-703ZB | 581 |
| SOL3111-093-09 | 58130-ZV4-030ZB | 581 |
| SOL3111-093-10 | | 581 |
| SOL3111-093-11 | | 581 |
| SOL3111-110-15 | | 581 |
| SOL3111-110-16 | | 581 |
| SOL3111-110-17 | | 581 |
| SOL3111-111-13 | 58130-ZV5-000ZA | 581 |
| SOL3111-111-14 | 58130-ZV5-870ZA | 581 |
| SOL3111-114-12 | 58130-ZV5-850ZA | 581 |
| SOL3111-116-11 | | 581 |
| SOL3111-121-09 | 58130-ZV5-860ZA | 581 |
| SOL5211-099-09 | 58130-ZV7-850ZA | 581 |
| SOL5211-099-10 | | 581 |
| SOL5211-099-11 | 58130-ZV7-000ZA | 581 |
| SOL5211-099-12 | | 581 |
| SOL5211-099-13 | | 581 |
| SOL6001-073-06P | 58130-ZV0-841ZB | 581 |
| SOL6011-079-06P | | 581 |
| SOL6011-079-07P | | 581 |
| SOL6411-130-19 | 58130-ZW1-W41ZA | 581 |
| SOL6411-130-21 | 58130-ZW1-W41ZA | 581 |
| SOL6411-133-17 | 58130-ZW1-W31ZA | 581 |
| SOL6411-135-14 | | 581 |
| SOL6411-135-15 | 58130-ZW1-W21ZA | 581 |
| SOL6411-138-13 | 58130-ZW1-W11ZA | 581 |
| SOL6411-140-11 | 58130-ZW1-W01ZA | 581 |
| SOL6412-133-17 | 58130-ZW1-W61ZA | 581 |
| SOL6412-135-15 | 58130-ZW1-W31ZA | 581 |
| SOL6413-125-19 | 58130-ZW1-W41ZA | 581 |
| SOL6413-125-21 | 58130-ZW1-W41ZA | 581 |
| SOL6413-128-17 | 58130-ZW1-W31ZA | 581 |
| SOL6413-130-15 | 58130-ZW1-W21ZA | 581 |
| SOL6413-133-13 | 58130-ZW1-W11ZA | 581 |
| SOL6431-130-19 | 58130-ZW1-W41ZA | 581 |
| SOL6431-130-21 | 58130-ZW1-W41ZA | 581 |
| SOL6431-133-17 | 58130-ZW1-W31ZA | 581 |
| SOL6431-135-15 | 58130-ZW1-W21ZA | 581 |
| SOL6431-138-13 | 58130-ZW1-W11ZA | 581 |
| SOL6431-140-11 | 58130-ZW1-W01ZA | 581 |
| SOL9311-110-15 | | 582 |
| SOL9311-111-13 | | 582 |
| SOL9311-111-14 | | 582 |
| SOL9311-114-12 | | 582 |
| SOL9311-116-11 | | 582 |
| SOL9311-120-10 | | 582 |
| SOL9311-121-09 | | 582 |
| SOL9331-110-15 | | 582 |
| SOL9331-111-13 | | 582 |
| SOL9331-111-14 | | 582 |
| SOL9331-111-14 | | 582 |
| SOL9331-111-14 | | 582 |
| SOL9331-116-11 | | 582 |
| SOL9331-120-10 | | 582 |
| SOL9331-121-09 | | 582 |
| SOL9331-130-19 | | 582 |
| SOL9331-133-17 | | 582 |
| SOL9331-135-15 | | 582 |
| SOL9331-138-13 | | 582 |
| SOL9331-140-09 | | 582 |

| REF | R.O. / OEM | 582 | REF | R.O. / OEM | 582 | REF | R.O. / OEM | 572 |
|----------------|------------|-----|----------------|---------------|---------|---------------|------------------|---------|
| SOL9532-140-21 | | 582 | SOL9572-158-15 | | 582 | TEN01408 | 12155-ZV4-A00 | 572 |
| SOL9532-140-23 | | 582 | SOLRBX-102 | | 582 | TEN01408/1 | 12155-ZV5-000 | 545-572 |
| SOL9532-143-17 | | 582 | SOLRBX-107 | | 582 | TEN01409 | 41106-ZW9-000 | 572 |
| SOL9532-145-15 | | 582 | SOLRBX-113 | | 582 | TEN01410 | 41107-ZW1-B01ZA | 572 |
| SOL9571-145-25 | | 582 | | | | TEN01411 | 41107-ZV1-003-ZA | 572 |
| SOL9571-148-23 | | 582 | | | | TEN01412 | 06412-ZV5-000 | 572 |
| SOL9571-150-21 | | 582 | TEN01400 | 41106-ZW-000 | 572 | TENKITHONDABF | | 572 |
| SOL9571-153-19 | | 582 | TEN01401 | 41106-935-812 | 572 | THKS-1 | | 561 |
| SOL9571-155-17 | | 582 | TEN01402 | 41106-ZV4-650 | 545-572 | THKS-12 | | 561 |
| SOL9571-158-15 | | 582 | TEN01403 | 41107-ZV5-000 | 572 | THKS-2 | | 561 |
| SOL9572-145-25 | | 582 | TEN01404 | 06411-ZV5-000 | 572 | THKS-22 | | 561 |
| SOL9572-148-23 | | 582 | TEN01404 | 06411-ZV5-020 | 572 | THL-4 | | 561 |
| SOL9572-150-21 | | 582 | TEN01405 | 06411-ZV1-000 | 572 | TRI305-0386 | | 547 |
| SOL9572-153-19 | | 582 | TEN01406 | 06411-ZV1-000 | 572 | TRI305-0566 | | 547 |
| SOL9572-155-17 | | 582 | TEN01407 | 41109-ZW1-B00 | 572 | | | |

RO / OEM --> REF

| R.O. / OEM | REF | 574 | R.O. / OEM | REF | 553 | R.O. / OEM | REF | 546-552 |
|-----------------|------------------|-------------|-------------------|--------------------|-------------|-----------------|--------------------|-------------|
| 06111-ZW1-000 | RM06111-ZW1-020 | 574 | 08207-10W30M-FC-W | REC10W30U3 | 553 | 16900-SR3-004 | REC16900-SR3-004 | 546-552 |
| 06111-ZW1-020 | RM06111-ZW1-020 | 574 | 08207-5W30M2 | REC5W40U3 | 553 | 16900-ST5-993 | REC16010-ST5-993 | 553 |
| 06160-ZV4-U11 | REC06160-ZV4-U11 | 556 | 08209-10W30M-FC-W | REC10W30U6 | 553 | 16901-ZY3-003 | REC16901-ZY3-003 | 553 |
| 06160-ZV4-U11 | REC16010-ZV4-005 | 556 | 08739-90W | REC80W90U3 | 553 | 16910-ZV4-015 | REC16910-ZV4-015 | 545-552 |
| 06164-PCA-000 | REC06164-PCA-000 | 555 | 08M60-ZW7-A00 | SOL1531-140-19 | 581 | 16911-ZY3-003 | REC16901-ZY3-003 | 553 |
| 06176-ZW3-801AH | RAC025-RAC-02 | 553 | 08M60-ZW7-A10 | SOL1531-140-21 | 581 | 16911-ZY3-010 | REC16911-ZY3-010 | 546-553 |
| 06177-ZW1-801AH | RAC320R-INOX-01 | 551 | 08M60-ZW7-A30 | SOL1531-140-23 | 581 | 16911-ZZ5-003 | REC16911-ZZ5-003 | 546-553 |
| 06177-ZW1-801AH | RAC320R-RAC-03 | 550-551 | 08M60-ZW7-A20 | SOL1531-140-25 | 581 | 17105-ZY3-004 | REC17105-ZY3-004 | 575 |
| 06177-ZX2-000HE | REC24942 | 549 | 08M60-ZW7-A40 | SOL1531-145-15 | 581 | 17105-ZY6-000 | REC17105-ZY6-000 | 575 |
| 06177-ZX2-000HE | REC24952 | 549 | 116977-ZV5-900 | GS31032 | 549 | 17109-ZY3-004 | REC17109-ZY3-004 | 575 |
| 06178-ZW1-030GH | RAC120R-RAC-01 | 551 | 116977-ZV5-A00 | GS31033 | 549 | 17109-ZY6-000 | REC17109-ZY6-000 | 575 |
| 06192-881-C00 | REC06192-881-C00 | 570 | 12-191833 | REC12-191833 | 545-546-574 | 17151-ZW5-000 | REC17151-ZW5-000 | 575 |
| 06192-ZV1-305 | REC06192-ZV1-305 | 546-570 | 12155-ZV4-A00 | TEN01408 | 572 | 17384-ZW4-000 | REC17384-ZW4-000 | 574 |
| 06192-ZV1-000 | REC06192-ZV1-C00 | 570 | 12155-ZV5-000 | CM826134 | 571 | 17650-921-003ZB | GS31034 | 548 |
| 06192-ZV1-000 | REC06192-ZV1-000 | 570 | 12155-ZV5-000 | CM826134A | 571 | 17660-ZV5-902 | GS31030 | 548 |
| 06192-ZV1-C00 | REC06192-ZV1-C00 | 545-570 | 12155-ZV5-000 | TEN01408/1 | 545-572 | 17660-ZV5-A00 | GS31031 | 548 |
| 06192-ZV4-000 | REC06192-ZV4-000 | 545-570 | 12209-GB4-681 | REC12209-GB4-681 | 575 | 17660-ZW9-003 | GS31031 | 548 |
| 06192-ZV5-003 | REC06192-ZV5-003 | 545-546-570 | 12251-ZV5-000 | REC12251-ZV5-003 | 573 | 17670-ZW1-030GH | LENS3240 | 551 |
| 06192-ZV7-000 | REC06192-ZV7-000 | 545-570 | 12251-ZV5-003 | REC12251-ZV5-003 | 573 | 17670-ZW1-801AH | RACS3213 | 550-551 |
| 06192-ZW1-000 | REC06192-ZV1-000 | 546-570 | 12251-ZV7-004 | REC12251-ZV7-004 | 573 | 17670-ZW1-801AH | RACS3213 | 550-551 |
| 06192-ZW1-305 | REC06192-ZV1-305 | 570 | 12251-ZW1-004 | REC12251-ZW1-014 | 573 | 17670-ZW3-801AH | RACS2502 | 553 |
| 06192-ZW2-000 | REC06192-ZV7-000 | 570 | 12251-ZW1-014 | REC12251-ZW1-014 | 573 | 17710-ZW9-023 | REC17710-ZW9-033 | 548 |
| 06192-ZW9-A30 | REC06192-ZW9-A30 | 545-570 | 12251-ZW4-H01 | REC12251-ZV5-003 | 573 | 17710-ZW9-033 | REC17710-ZW9-033 | 548 |
| 06192-ZX2-000 | REC06192-ZY3-000 | 570 | 12251-ZW5-003 | REC12251-ZW5-023 | 573 | 17822-90J00 | REC09401-11425 | 548 |
| 06192-ZY3-000 | REC06192-ZY3-000 | 546-570 | 12251-ZW5-013 | REC12251-ZW5-023 | 573 | 17822-90J00 | REC09401-11425BULK | 548 |
| 06192-ZY6-000 | REC06192-ZY6-000 | 546-570 | 12251-ZW5-023 | REC12251-ZW5-023 | 573 | 19021-ZW1-003 | REC47-43026Q06 | 570-577 |
| 06193-ZV5-000 | REC06193-ZV5-020 | 570 | 14400-921-010 | RM14400-921-024 | 574 | 19120-ZW1-303 | REC47-43026Q02 | 577 |
| 06193-ZV5-010 | REC06193-ZV5-020 | 570 | 14400-921-024 | RM14400-921-024 | 574 | 19210-881-003 | REC19210-881-003 | 568 |
| 06193-ZV5-020 | REC06193-ZV5-020 | 570 | 14400-ZV4-004 | RM14400-ZV4-004 | 574 | 19210-881-A01 | REC19210-881-003 | 568 |
| 061A1-ZV0-000 | RM061A1-ZV0-000 | 574 | 14400-ZV5-004 | REC14400-ZV5-014 | 574 | 19210-881-A02 | REC19210-881-003 | 568 |
| 06211-ZV1-505 | REC06211-ZV1-505 | 545 | 14400-ZV5-014 | REC14400-ZV5-014 | 574 | 19210-ZV4-013 | CEF500328 | 568 |
| 06211-ZV4-505 | REC06211-ZV4-505 | 545 | 14400-ZW1-004 | RM14400-ZW1-004 | 574 | 19210-ZV4-013 | REC19210-ZV4-013 | 567-568 |
| 06211-ZV5-505 | REC06211-ZV5-505 | 545 | 14400-ZZ3-004 | REC14400-ZZ3-004 | 574 | 19210-ZV4-651 | CEF500343 | 568 |
| 06211-ZV7-505 | REC06211-ZV7-505 | 545 | 15112-ZW5-003 | REC15112-ZW5-003 | 573 | 19210-ZV4-651 | REC06192-ZV4-000 | 570 |
| 06211-ZW0-505 | REC06211-ZW0-505 | 546 | 15400-PFB-004 | REC35-822626Q03 | 554 | 19210-ZV4-651 | REC19210-ZV4-651 | 567-568 |
| 06211-ZW5-505 | REC06211-ZW5-505 | 546 | 15400-PFB-007 | REC35-822626Q03 | 554 | 19210-ZV5-003 | CEF500338 | 568 |
| 06211-ZW9-505 | REC06211-ZW9-505 | 545 | 15400-PFB-014 | REC35-822626Q03 | 554 | 19210-ZV5-003 | REC19210-ZV5-003 | 546-568-576 |
| 06211-ZY0-505 | REC06211-ZY0-505 | 545 | 15400-PFRB-007 | REC35-822626Q03 | 554 | 19210-ZV7-003 | CEF500339 | 568 |
| 06211-ZY2-506 | REC06211-ZY2-506 | 546 | 15400-PH1-F03 | REC15400-PLM-A01PE | 554 | 19210-ZV7-003 | REC19210-ZV7-003 | 567-568 |
| 06211-ZY5-505 | REC06211-ZY5-505 | 546 | 15400-PJ7-015 | REC35-822626Q03 | 554 | 19210-ZW1-303 | CEF500301 | 568 |
| 06211-ZY9-505 | REC06211-ZY9-505 | 546 | 15400-PLM-A01PE | REC15400-PLM-A01PE | 554 | 19210-ZW1-303 | REC47-43026Q02 | 567-568 |
| 06211-ZZ3-506 | REC06211-ZZ3-506 | 546 | 15400-PM3-004 | REC35-822626Q03 | 554 | 19210-ZW1-B02 | REC19210-ZW1-B02 | 568 |
| 06211-ZZ5-505 | REC06211-ZZ5-505 | 546 | 15400-PM3-405 | REC35-822626Q03 | 554 | 19210-ZW1-B04 | CEF500337 | 568 |
| 06240-ZW5-U40 | REC06240-ZW5-U40 | 564 | 15400-POH-305 | REC15400-PLM-A01PE | 554 | 19210-ZW1-B04 | REC19210-ZW1-B02 | 568 |
| 06240-ZW5-U001 | REC06240-ZW5-U40 | 564 | 15400-POH-305PE | REC15400-PLM-A01PE | 554 | 19210-ZW1-B04 | REC19210-ZW1-B02 | 568 |
| 06240-ZW5-U60 | REC06240-ZW5-U60 | 564 | 15400-RBA-F01 | REC15400-RBA-F01 | 546-554 | 19210-ZW9-003 | REC19210-ZW9-013 | 567 |
| 06411-ZV1-000 | TEN01405 | 572 | 15400-RBA-F01 | REC15400-RBA-F01 | 546-554 | 19210-ZW9-013 | CEF500347 | 568 |
| 06411-ZV1-000 | TEN01406 | 572 | 15400-RTA-003 | REC15400-PLM-A01PE | 554 | 19210-ZW9-013 | REC19210-ZW9-013 | 545-567-568 |
| 06411-ZV5-000 | CM06411-ZV5-000 | 571 | 15400-RTA-004 | REC15400-PLM-A01PE | 554 | 19210-ZW9-A32 | REC19210-ZW9-A32 | 568 |
| 06411-ZV5-000 | CM06411-ZV5-000A | 571 | 15400-ZJ1-004 | REC15400-PLM-A01PE | 546-554 | 19210-ZW9-A32 | CEF500348 | 568 |
| 06411-ZV5-000 | TEN01404 | 572 | 15400-ZW4-003 | REC35-822626Q03 | 545-546-554 | 19210-ZW9-A32 | REC19210-ZW9-A32 | 568 |
| 06411-ZV5-020 | CM06411-ZV5-000 | 571 | 16010-ZV4-005 | REC16010-ZV4-005 | 556 | 19210-ZY3-003 | CEF500391 | 568 |
| 06411-ZV5-020 | CM06411-ZV5-000A | 571 | 16010-ZW9-003 | REC16010-ZW9-003 | 556 | 19210-ZY3-003 | REC19210-ZY3-003 | 568 |
| 06411-ZV5-020 | TEN01404 | 572 | 16011-881-741 | REC16011-881-741 | 555 | 19210-ZY9-H01 | REC19210-ZY9-H01 | 567-568 |
| 06411-ZW1-000 | CM06411-ZW1-000 | 571 | 16011-ZV4-005 | REC16011-ZV4-005 | 555 | 19211-ZV0-003 | RM19211-ZV0-003 | 568 |
| 06411-ZW1-000 | CM06411-ZW1-000A | 571 | 16201-881-850 | REC16201-881-850 | 575 | 19221-ZV5-000 | REC19221-ZV5-000 | 576 |
| 06411-ZW1-020 | CM06411-ZW1-000 | 571 | 16221-ZV4-610 | REC16221-ZV4-610 | 575 | 19223-ZV5-000 | REC19223-ZV5-000 | 576 |
| 06411-ZW1-020 | CM06411-ZW1-000A | 571 | 16221-ZW1-000 | REC16221-ZW1-000 | 575 | 19231-ZV5-000 | REC19231-ZV5-000 | 576 |
| 06412-ZV1-000 | CM31640 | 572 | 16221-ZW9-000 | REC16221-ZW9-000 | 575 | 19231-ZW1-003 | REC8172761 | 569-577 |
| 06412-ZV1-000 | CM31640A | 572 | 16700-ZV5-003 | REC16700-ZV5-003 | 555 | 19232-881-850 | REC19232-881-850 | 569 |
| 06412-ZV5-000 | CM41107-ZV500 | 572 | 16700-ZW1-004 | REC16700-ZW1-004 | 555 | 19232-ZV1-A10 | REC19232-ZV1-A10 | 569 |
| 06412-ZV5-000 | CM41107-ZV500A | 572 | 16735-ZW5-003 | REC16735-ZW5-003 | 555 | 19232-ZV4-610 | REC19232-ZV4-610 | 569 |
| 06412-ZV5-000 | TEN01412 | 572 | 16735-ZY3-004 | REC16735-ZY3-004 | 555 | 19232-ZW1-003 | REC27-8172771 | 569-577 |
| 06412-ZV5-000 | CM664-45371-01 | 572 | 16900-GB2-005 | REC16900-GB2-005 | 545-552 | 19233-ZV5-000 | REC19233-ZV5-000 | 569-576 |
| 06412-ZV5-000 | CM664-45371-01A | 572 | 16900-SA5-004 | REC16900-SA5-004 | 545-546-552 | 19234-881-850 | REC19234-881-850 | 569 |
| | | | | | | 19234-ZW1-003 | REC27-430331 | 569-577 |

| R.O. / OEM | REF | R.O. / OEM | REF | R.O. / OEM | REF | | | |
|---------------------|------------------|-----------------|------------------|-------------------|----------------|----------------|------------------|-------------|
| 19234-ZY3-000 | REC19234-ZY3-000 | 569 | 35100-ZV5-013 | REC35100-ZV5-013 | 565 | 58233-ZY3-A19H | SOL1511-145-19 | 581 |
| 19242-ZV5-000 | REC19242-ZV5-000 | 569-576 | 35340-ZZ5-D21 | REC35340-ZZ5-D21 | 565 | 58233-ZY3-A19H | SOL1513-143-19 | 581 |
| 19242-ZW1-003 | REC27-430472 | 569-577 | 35370-ZW5-U02 | REC35370-ZW5-U02 | 565 | 58233-ZY3-A21H | SOL1511-143-21 | 581 |
| 19253-ZV5-000 | REC19253-ZV5-000 | 576 | 35370-ZW5-U12 | REC35370-ZW5-U12 | 565 | 58233-ZY3-A21H | SOL1513-140-21 | 581 |
| 19300-881-741 | PAF15-07000031 | 566 | 35370-ZZ5-D02 | REC35370-ZZ5-D02 | 565 | 58233-ZY3-A23H | SOL1511-142-23 | 581 |
| 19300-881-761 | REC19300-881-761 | 545-566-567 | 35655-ZY3-013 | REC35655-ZY3-013 | 558 | 58233-ZY3-A23H | SOL1513-140-23 | 581 |
| 19300-921-003 | PAF15-07000031 | 566 | 35655-ZY9-003 | REC35655-ZY9-003 | 558 | 58233-ZY3-B15H | SOL1532-145-15 | 581 |
| 19300-ZV5-003 | REC19300-ZV5-043 | 566 | 35668-ZY6-003 | REC35668-ZY6-003 | 558 | 58233-ZY3-B17H | SOL1532-143-17 | 581 |
| 19300-ZV5-013 | REC19300-ZV5-043 | 566 | 36120-ZV5-821 | PH200-T021 | 562 | 58233-ZY3-B19H | SOL1532-140-19 | 581 |
| 19300-ZV5-023 | REC19300-ZV5-043 | 566 | 36120-ZV5-822 | PH200-T046 | 562 | 90301-ZW1-003 | REC90301-ZW1-003 | 577 |
| 19300-ZV5-033 | REC19300-ZV5-043 | 566 | 36120-ZW4-H12 | REC36120-ZW4-H12 | 563 | 90507-921-000 | PAF15-04000003 | 545-546 |
| 19300-ZV5-043 | REC19300-ZV5-043 | 546-566-567 | 36120-ZY3-013 | REC36120-ZY3-013 | 563 | 90508-ZW1-003 | REC90508-ZW1-003 | 577-579 |
| 19300-ZW9-003 | PAF15-07000031 | 545-546-566-567 | 36120-ZY6-013 | REC36120-ZY6-013 | 563 | 90752-ZV4-650 | REC90752-ZV4-650 | 569 |
| 19300-ZX2-003 | REC67F-12411-01 | 566-567 | 36120-ZY6-023 | REC36120-ZY6-013 | 563 | 90752-ZV5-003 | REC90752-ZV5-003 | 546-569-576 |
| 19300-ZY3-023 | REC6AH-12411-00 | 566-567 | 36120-ZY9-003 | REC36120-ZY9-003 | 563 | 90752-ZV7-000 | REC90752-ZV7-000 | 569 |
| 19300-ZY6-003 | REC6E5-12411-30 | 566-567 | 36180-ZV5-003 | REC36180-ZV5-033 | 561 | 90752-ZW1-003 | REC90752-ZW1-B02 | 577 |
| 2155-ZV5-000 | CM6E0-45251-11 | 572 | 36180-ZV5-013 | REC36180-ZV5-033 | 561 | 90752-ZW1-B02 | REC90752-ZW1-B02 | 569 |
| 2155-ZV5-000 | CM6E0-45251-11A | 572 | 36180-ZV5-023 | REC36180-ZV5-033 | 561 | 90752-ZY3-003 | REC90752-ZY3-003 | 569 |
| 23172-ZW1-013 | REC23172-ZW1-013 | 573 | 36180-ZV5-033 | REC36180-ZV5-033 | 561 | 90758-ZV1-000 | PAGB/T91-2.5X30 | 545-546 |
| 23172-ZW5-000 | REC23172-ZW5-013 | 573 | 37260-RNA-A01 | REC37260-RNA-A01 | 557 | 91051-ZW1-003 | REC31-3089AA1 | 577-579 |
| 23172-ZW5-013 | REC23172-ZW5-013 | 573 | 37500-PNB-003 | REC37500-PNB-003 | 557 | 91053-ZW1-003 | REC387247 | 577-579 |
| 24800-ZZ5-A01 | REC24800-ZZ5-A02 | 564 | 37510-PNB-003 | REC37510-PNB-003 | 557 | 91057-ZW1-003 | REC31-30895T | 577-579 |
| 24800-ZZ5-A02 | REC24800-ZZ5-A02 | 564 | 37830-PGK-A01 | REC37830-PGK-A01 | 557 | 91251-ZV5-003 | REC91251-ZV5-003 | 576 |
| 24800-ZZ5-A22 | REC24800-ZZ5-A02 | 564 | 37830-PNC-003 | REC37830-PNC-003 | 557 | 91251-ZW1-003 | REC26-43035 | 577-578 |
| 24911-ZW7-U01 | PRE3300C05 | 565 | 37830-RNA-A01 | REC37830-RNA-A01 | 557 | 91252-935-004 | REC91252-935-004 | 570 |
| 24912-ZW7-U01 | PRE3300C06 | 565 | 37840-R70-A01 | REC37840-R70-A01 | 557 | 91252-ZV1-003 | REC91252-ZV1-003 | 570 |
| 24913-ZW7-U01 | PRE3300C07 | 565 | 37880-PLC-004 | REC37880-PLC-004 | 558 | 91252-ZW1-003 | REC26-76868 | 577-578 |
| 24914-ZW7-U01 | PRE3300C08 | 565 | 41106-935-812 | TENO1401 | 572 | 91253-ZW1-003 | REC26-6164641 | 577-578 |
| 24915-ZW7-U01 | PRE3300C09 | 565 | 41106-ZV4-650 | TENO1402 | 545-572 | 91254-ZW1-003 | REC26-43036 | 577-578 |
| 24916-ZW7-U01 | PRE3300C10 | 565 | 41106-ZW-000 | TENO1400 | 572 | 91255-ZW1-003 | REC26-70081 | 578 |
| 24917-ZW7-U01 | PRE3300C11 | 565 | 41106-ZW9-000 | CM41106-ZW9-000A | 572 | 91351-740-003 | REC91351-740-003 | 576 |
| 24918-ZW7-U01 | PRE3300C12 | 565 | 41106-ZW9-000 | CM41106-ZW9-09000 | 572 | 91351-ZW1-003 | REC26-70081 | 577-578 |
| 24919-ZW7-U01 | PRE3300C13 | 565 | 41106-ZW9-000 | TENO1409 | 572 | 91353-ZV5-003 | REC91353-ZV5-00 | 576 |
| 24920-ZW7-U01 | PRE3300C14 | 565 | 41106-ZW9-090 | CM41106-ZW9-09000 | 545 | 91353-ZW1-003 | REC25-457101 | 577-578 |
| 24921-ZW7-U01 | PRE3300C15 | 565 | 41106ZW909000 | CM41106-ZW9-000A | 572 | 91355-ZV5-000 | REC91555-ZV5-000 | 576 |
| 24922-ZW7-U01 | PRE3300C16 | 565 | 41106ZW909000 | CM41106-ZW9-09000 | 572 | 91356-ZV5-000 | REC91356-ZV5-000 | 576 |
| 24923-ZW7-U01 | PRE3300C17 | 565 | 41107-ZV1-003-ZA | TENO1411 | 572 | 98059-55916 | NGKCR5EH-9 | 545-559 |
| 24924-ZW7-U01 | PRE3300C18 | 565 | 41107-ZV5-000 | CM41107-ZV500A | 545 | 98066-55716 | NGKDR5H5 | 559 |
| 24925-ZW7-U01 | PRE3300C19 | 565 | 41107-ZV5-000 | TENO1403 | 572 | 98069-5771P | NGKDR7EA | 545-546-559 |
| 24926-ZW7-U01 | PRE3300C20 | 565 | 41107-ZW1-B01ZA | TENO1410 | 572 | 98069-5777P | NGKDR7EB | 546 |
| 24927-ZW7-U01 | PRE3300C21 | 565 | 41107Z2W1003 | CM31640 | 572 | 98079-55846 | NGKBPR5ES | 545-559 |
| 24928-ZW7-U01 | PRE3300C22 | 565 | 41107Z2W1003 | CM31640A | 572 | HXZ2-30520-003 | REC30520-ZX2-003 | 559 |
| 24929-ZW7-U01 | PRE3300C23 | 565 | 41107ZV500 | CM41107-ZV500 | 572 | HZY-38580-003 | REC38580-ZY9-023 | 558 |
| 24930-ZW7-U01 | PRE3300C24 | 565 | 41107ZV500 | CM41107-ZV500A | 572 | HZY-638550-003 | REC38550-ZY6-003 | 563 |
| 24931-ZW7-U01 | PRE3300C25 | 565 | 41107ZW1-B01 | CM41107-ZW1-B01 | 572 | | | |
| 24932-ZW7-U01 | PRE3300C26 | 565 | 41107ZW1-B01 | CM41107-ZW1-B01A | 572 | | | |
| 24933-ZW7-U01 | PRE3300C27 | 565 | 41109-ZV5-000 | REC41109-ZV5-000 | 579 | | | |
| 24934-ZW7-U01 | PRE3300C28 | 565 | 41109-ZW1-003 | CM826134 | 571 | | | |
| 24935-ZW7-U01 | PRE3300C29 | 565 | 41109-ZW1-003 | CM826134A | 571 | | | |
| 24936-ZW7-U01 | PRE3300C30 | 565 | 41109-ZW1-B00 | CM41109-ZW1-B00 | 571 | | | |
| 24937-ZW7-U01 | PRE3300C31 | 565 | 41109-ZW1-B00 | CM41109-ZW1-B00A | 571 | | | |
| 24938-ZW7-U01 | PRE3300C32 | 565 | 41109-ZW1-B00 | TENO1407 | 572 | | | |
| 30520-PNA-007 | REC30520-PNA-007 | 559 | 41161-ZV5-000 | REC41161-ZV5-000 | 579 | | | |
| 30520-PWC-S01 | REC30520-PWC-003 | 559 | 58130-ZV0-841ZB | SOL6001-073-06P | 581 | | | |
| 30520-ZX2-003 | REC30520-ZX2-002 | 559 | 58130-ZV4-030ZB | SOL3111-093-09 | 581 | | | |
| 30520-ZYL-003 | REC30520-ZYL-002 | 559 | 58130-ZV4-703ZB | SOL3111-093-08 | 581 | | | |
| 30520-ZY3-003 | REC30520-ZY3-002 | 559 | 58130-ZV5-000ZA | SOL3311-111-13 | 581 | | | |
| 30530-P8F-A01 | REC30530-P8F-A01 | 558 | 58130-ZV5-850ZA | SOL3311-114-12 | 581 | | | |
| 30530-PNA-003 | REC30530-PNA-003 | 558 | 58130-ZV5-860ZA | SOL3311-121-09 | 581 | | | |
| 30530-RNA-A01 | REC30530-RNA-A01 | 558 | 58130-ZV5-870ZA | SOL3311-111-14 | 581 | | | |
| 30580-ZV4-023 | REC30580-ZV4-013 | 559 | 58130-ZV7-000ZA | SOL5211-099-11 | 581 | | | |
| 38550-ZV5-023 | REC38550-ZV5-023 | 563 | 58130-ZV7-850ZA | SOL5211-099-09 | 581 | | | |
| 38550-ZY6-003 | REC38550-ZY6-006 | 563 | 58130-ZW1-W01ZA | SOL6411-140-11 | 581 | | | |
| 38580-ZY6-003/13 | REC38580-ZY6-013 | 558 | 58130-ZW1-W01ZA | SOL6431-140-11 | 581 | | | |
| 38580-ZY9-003/13/23 | REC38580-ZY9-023 | 558 | 58130-ZW1-W11ZA | SOL6411-138-13 | 581 | | | |
| 31200-ZV5-003 | PH130-0054 | 560 | 58130-ZW1-W11ZA | SOL6413-133-13 | 581 | | | |
| 31200-ZV5-013 | PH130-0054 | 560 | 58130-ZW1-W11ZA | SOL6431-138-13 | 581 | | | |
| 31200-ZW1-004 | PH130-0064 | 560 | 58130-ZW1-W21ZA | SOL6411-135-15 | 581 | | | |
| 31200-ZW5-003 | PH130-0065 | 560 | 58130-ZW1-W21ZA | SOL6413-130-15 | 581 | | | |
| 31200-ZW9-801 | REC31200-ZW9-802 | 560 | 58130-ZW1-W21ZA | SOL6431-135-15 | 581 | | | |
| 31200-ZW9-802 | REC31200-ZW9-802 | 560 | 58130-ZW1-W31ZA | SOL6411-133-17 | 581 | | | |
| 31200-ZY3-003 | PH130-0070 | 560 | 58130-ZW1-W31ZA | SOL6412-135-15 | 581 | | | |
| 31200-ZY3A-0034 | PH130-0070 | 560 | 58130-ZW1-W31ZA | SOL6413-128-17 | 581 | | | |
| 31200-ZY6-003 | REC31200-ZY6-003 | 560 | 58130-ZW1-W31ZA | SOL6431-133-17 | 581 | | | |
| 31200-ZY9-003 | REC31200-ZY6-003 | 560 | 58130-ZW1-W41ZA | SOL6411-130-19 | 581 | | | |
| 31200-ZY9A-0031 | REC31200-ZY6-003 | 560 | 58130-ZW1-W41ZA | SOL6411-130-21 | 581 | | | |
| 31630-ZW5-003 | REC31630-ZW5-003 | 562 | 58130-ZW1-W41ZA | SOL6413-125-19 | 581 | | | |
| 31630-ZY3-003 | REC31630-ZY3-003 | 561 | 58130-ZW1-W41ZA | SOL6413-125-21 | 581 | | | |
| 31630-ZY6-003 | REC31630-ZY6-003 | 561 | 58130-ZW1-W41ZA | SOL6431-130-19 | 581 | | | |
| 31630-ZY6-013 | REC31630-ZY6-003 | 561 | 58130-ZW1-W41ZA | SOL6431-130-21 | 581 | | | |
| 31638-ZY3-003 | REC31638-ZY3-003 | 561-562 | 58130-ZW1-W61ZA | SOL6412-133-17 | 581 | | | |
| 31638-ZY6-003 | REC31638-ZY6-003 | 561-562 | 58233-ZY3-A15H | SOL1511-150-15 | 581 | | | |
| 31908-ZZ3-003 | NGKLMAR6C-9 | 546-559 | 58233-ZY3-A15H | SOL1513-148-15 | 581 | | | |
| 31916-ZX2-003 | NGKIZFR6K-11E | 559 | 58233-ZY3-A17H | SOL1511-148-17 | 581 | | | |
| 31916-ZY3-003 | NGKIZFR6K11 | 546-559 | 58233-ZY3-A17H | SOL1513-145-17 | 581 | | | |
| | | | | 58233-ZY3-A17H | SOL1531-143-17 | | | 581 |