



marinotech

30
years



catalog

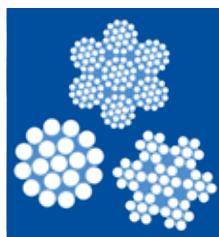

2 0 2 4



2 0 2 5

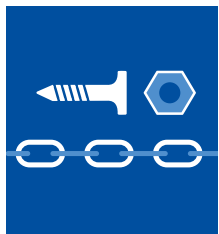

stainless steel

maritim & industrial fasteners

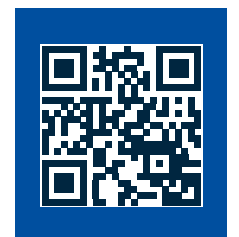
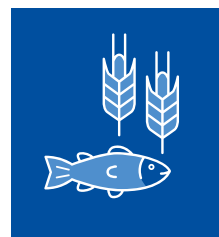

 **Einfach interaktiv vom Katalog in den Marinetech Shop**

 Easy from the catalogue to the Marinetech shop / The interactive PDF

 Simplement du catalogue à la boutique Marinetech / Le PDF interactif

 Simplemente del catálogo a la tienda de Marinetech / El PDF interactivo

 Bezpośrednio z katalogu do Marinetech Shop / Interaktywny PDF

Seite 10/11 • Page 10/11



Seite 12 • Page 12



Seite 39 • Page 39

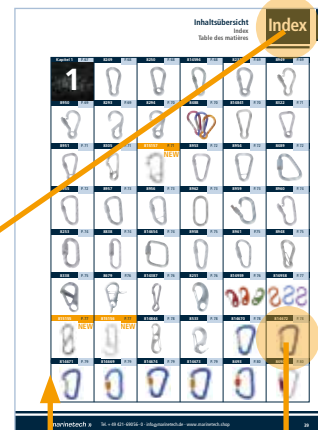

Seite 10/11 • Page 10/11



Seite 67 • Page 67



Seite 78 • Page 78

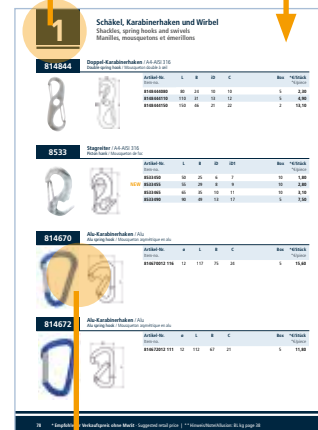

30
years



Wir sind ein Fachhandel



Profitieren Sie von Fachwissen und Fachqualität

Schnell, passend, professionell. Oder einzigartig, innovativ und kreativ. Je nachdem.

Mit Marinetech als Partner erhalten Sie genau das Equipment, das Sie brauchen und wünschen. Wir sind Spezialisten in Sachen Edelstahl, kennen nahezu jede Schraube, jeden Schäkel, jedes Scharnier – Abmessung, Verarbeitung und Materialqualität. Die Produkte und ihre Verwendungsmöglichkeiten sind uns absolut vertraut. Wir halten intensive Kontakte zu Herstellern sowie zu Konstrukteuren für die Entwicklung von Sonderteilen und wissen, was technisch möglich ist, was geht und was funktioniert.

Fünf gute Gründe für die Zusammenarbeit mit Marinetech:

Unser Team ...

1. ist vertraut mit den Gegebenheiten in der Arbeits- und Konstruktionswelt unserer Kunden und ihrer Branchen
2. verfügt über umfangreiche Kenntnisse zur Edelstahlproduktion, zu Herstellungsverfahren und Machbarkeiten wie Guss, Drehen, Fräsen, Kaltpressen, Schmieden, Biegen und Stanzen
3. kennt die Einsatzgebiete und Eigenschaften der unterschiedlichen Edelstähle wie A2 / AISI 304, A4 / AISI 316 und von Duplexmaterialien genau
4. denkt weiter – auch rund um Verpackungen und Systeme für die erfolgreiche Produktpräsentation am Point of Sale
5. ist im globalen Herstellernetzwerk zu Hause

 Ihr Produkt ist nicht in unserem Sortiment? Wir machen uns auf die Suche und erarbeiten mit Ihnen die beste Lösung.



Benefit from specialist expertise and professional quality

With Marinetech as your partner, you get exactly the equipment you need and want. We are specialists in stainless steel, and we know almost every screw, every shackle, every hinge – including dimensions, workmanship, material quality and possible uses. We keep in close contact with manufacturers and designers.

Our team ...

- is not only familiar with the peculiarities of our customers' working and construction environments but also has extensive knowledge of stainless steel production, manufacturing processes and feasibility
- what's more, they know all about the areas of application and properties of different stainless steels such as A2 / AISI 304, A4 / AISI 316 or duplex materials, and they like to think ahead
- finally, they're right at home in the global manufacturer network and will always find the best solution for you when it comes to packaging and systems for successful product presentation at the point of sale



Profitez de la savoir-faire technique et qualité professionnelle

Avec Marinetech comme partenaire, vous obtenez précisément l'équipement que vous recherchez et dont vous avez besoin. Nous sommes des spécialistes de l'acier inoxydable et connaissons pratiquement chaque vis, chaque manille et chaque charnière – dimensions, traitement, qualité de matériau et possibilités d'utilisation n'ont pas de secret pour nous. Nous entretenons des contacts étroits avec les fabricants et constructeurs.

Notre équipe...

- connaît les particularités du monde du travail et de la construction de nos clients
- a des connaissances approfondies sur la production d'articles en acier inoxydable, les procédés de fabrication et la faisabilité de telle ou telle demande
- connaît les domaines d'application et les spécificités des différents aciers inoxydables comme l'acier A2/AISI 304, A4/AISI 316 ou les aciers duplex
- anticipe vos attentes – y compris en matière d'emballages et de systèmes permettant une présentation efficace des produits au point de vente
- est comme chez elle au sein du réseau de fabricants mondial et trouve toujours la meilleure solution pour vous



Beneficiarse de la experiencia y la calidad profesional

Con Marinetech como socio, usted obtiene exactamente el equipo que necesita y desea. Somos especialistas en acero inoxidable y conocemos prácticamente todos los tornillos, todos los grilletes y todas las bisagras: desde las dimensiones hasta el procesamiento, pasando por la calidad del material y las posibles aplicaciones. Mantenemos un estrecho contacto con los fabricantes y diseñadores.

Nuestro equipo ...

- está familiarizado con las condiciones a las que se enfrentan nuestros clientes en el entorno de trabajo y de diseño
- dispone de amplios conocimientos sobre la producción del acero inoxidable y sobre los procesos de fabricación y su viabilidad
- conoce los ámbitos de aplicación y las características de los diversos aceros inoxidable, como el A2 / AISI 304, el A4 / AISI 316 o los materiales dúplex
- tiene visión de futuro, también en lo relativo a los embalajes y a los sistemas para una presentación exitosa de los productos en el punto de venta
- está bien situado en la red mundial de fabricantes y encuentra siempre la mejor solución para usted



Korzystaj z wiedzy i profesjonalnej jakości

Z Marinetech jako swoim partnerem otrzymujesz dokładnie taki sprzęt, jakiego potrzebujesz i chcesz. Jesteśmy specjalistami w zakresie stali nierdzewnej, znamy prawie każdy wkręt, każdą szkęłę, każdy zawias – ich wymiary, wykonanie, jakość materiału, możliwości zastosowania. Utrzymujemy intensywne kontakty zarówno z producentami, jak i konstruktorami.

Nasz zespół ...

- zna warunki eksploatacji i projektowania naszych klientów
- dysponuje szeroką wiedzą na temat wytwarzania stali nierdzewnej, procesów produkcyjnych i wykonalność
- zna obszary zastosowań i właściwości różnych gatunków stali nierdzewnej, takich jak A2 / AISI 304, A4 / AISI 316 czy materiałów duplex i myśli perspektywnie
- ma doskonale rozeznanie na globalnym rynku producentów opakowań i systemów odpowiedniej prezentacji produktu w punkcie sprzedaży i zawsze znajduje najlepsze rozwiązanie dla naszych klientów

Ein gutes Konzept -

Seit 30 Jahren

24 / 7 / 365



Von Bremen in die Welt.

Hinter Marinetech steht ein großes Netzwerk aus Kompetenz, Technik, Raum und Manpower.

Verfügbarkeit ist für uns Pflicht

Herausforderungen in Sachen Terminierung, Produktbestellung und Logistik sind unser Alltag, Exklusivleistungen unser Standard. Wenn Sie mit uns telefonieren, merken Sie: Wir hören zu, fragen nach, denken mit und kümmern uns. Persönliche Kontakte sind gewollt und werden gern gepflegt, denn Beratung ist für uns Passion – damit Sie Ihre Ziele erreichen.

Internationale Bestellungen – ohne Missverständnisse

Unsere Mitarbeiterinnen und Mitarbeiter sprechen Ihre Sprache als Muttersprachler: Spanisch, Deutsch, Englisch, Französisch, Italienisch, Arabisch, Polnisch oder Russisch. Jedes Gespräch ist ein Vergnügen, denn der Kontakt ist typisch bremisch: ehrlich, bodenständig, sympathisch – und immer auf Augenhöhe. **Verlassen Sie sich auf uns!**

Marinetech Fakten

Gründungsjahr **1993**
founded in
année de fondation
año de fundación
rok założenia

Anzahl der Mitarbeiter **90**
Number of employees
Nombre d'employés
Número de empleados
Liczba pracowników

Logistikfläche **6.400 m²**
Logistics area
Zone logistique
Área de logística
Obszar logistyk

Verwaltungsfläche **1.300 m²**
Administrative area
Zone administrative
Área administrativa
Obszar administracyjny

Sortimentsgröße **38.000 Artikel**
Assortment size
Taille de l'assortiment
Tamaño de surtido
Wielkość zakresu

Palettenplätze **3.000**
Pallet spaces
Espaces de palettes
Espacios de palet
Miejsca paletowe

Langgutlagerung bis **7 m**
bulky goods storage up to
Stockage de marchandises longues jusqu'à
Almacenamiento de mercancías largas hasta
Składowanie towarów długich do

Versandpartner **DHL + DHL Express
DPD, Dachser + Winner**

Shipping partner
Partenaire d'expédition Socio de envío
Partner wysyłkowy



From Bremen into the world

Marinetech is backed by a large network of competence, technology, space and manpower. Being available is a matter of course for us; scheduling, product ordering and logistics challenges are part of our daily routine; and providing exclusive services is the standard we've set for ourselves. We listen, ask questions, think along with you and take care of matters at hand. We're passionate about giving personal advice so that you can achieve your goals.

International orders without misunderstandings

Our employees are native speakers of your language. Their approach is typical of Bremen: honest, down-to-earth, personable – and always on equal terms. **You can count on us!**



Depuis Brême dans le monde entier

Derrière Marineteck se trouve un vaste réseau de compétences, de techniques, de locaux et de main-d'œuvre. La disponibilité est pour nous une obligation, les défis en termes de délais, de commande de produits et de logistique sont notre quotidien, les prestations exclusives notre standard. Nous écoutons, nous nous informons, nous réfléchissons et agissons. Le conseil personnalisé est notre passion – et vous permet d'atteindre vos objectifs.

Des commandes internationales sans malentendus

Nos collaboratrices et collaborateurs parlent parfaitement votre langue car ce sont des locuteurs natifs. Le contact est typiquement brêmeois: sincère, authentique, sympathique, et toujours d'égal à égal. **Vous pouvez compter sur nous!**



Desde Bremen hacia todo el mundo.

Detrás de Marineteck hay una amplia red de conocimientos, tecnología, espacio y mano de obra. Para nosotros, la disponibilidad es una obligación, los desafíos en materia de programación, pedidos y logística, nuestro día a día, y los servicios exclusivos, nuestro estándar. Nosotros escuchamos, preguntamos, reflexionamos con usted, y nos ocupamos. Nos apasiona el asesoramiento personalizado, a fin de que pueda lograr sus objetivos.

Pedidos internacionales sin malentendidos

Nuestros empleados y empleadas hablan su mismo idioma como nativos. El trato es el típico del carácter de Bremen: franco, sensato, simpático y siempre de igual a igual. **¡Confíe en nosotros!**



Z Bremy w świat.

Za firmą Marineteck kryje się rozległa sieć kompetencji, technologii, przestrzeni i siły roboczej. Dostępność postrzegamy jako nasz obowiązek, wyzwania planistyczne, zamówienia na produkty i logistykę to dla nas codzienność, a ekskluzywny usługi to nasz standard. Słuchamy, pytamy, zastanawiamy się wspólnie z Wami i troszczymy się o Was. Osobiste doradztwo jest naszą pasją – abyście Wy mogli osiągać swoje cele.

Międzynarodowe zamówienia bez nieporozumień

Nasz personel mówi w Waszym języku jak jego rodowici użytkownicy. Kontakt z nami jest typowy dla Bremy: uczciwy, swojski, sympatyczny – i zawsze z pozycji partnera. **Zdajcie się na nas!**

Edelstahlprodukte nach höchsten Standards

Mit der MT-Serie erhalten Sie Produkte, die nach unseren Qualitäts- und Designvorgaben gefertigt wurden und somit exklusiv bei Marinetechnik erhältlich sind. Mit unserer eigenen Marke erweitern wir das Edelstahlsortiment um Produkte, die in dieser Form noch nicht auf dem Markt erhältlich sind. Hierbei kann es sich beispielsweise um ein Standardprodukt aus unserem Sortiment handeln, welches wir aus einem hochwertigeren Werkstoff oder in einer zusätzlichen Größe fertigen lassen. Es gibt jedoch auch MT-Produkte, die eine ganze neue Funktion aufweisen.

Inzwischen zählt die MT-Serie mehr als 30 Eigenentwicklungen. Jedes Jahr bringen wir mit unseren Neuheiten auch einige neue MT-Produkte auf den Markt. So wächst nicht nur unser Sortiment, sondern auch unsere Eigenmarke. Diese erkennt man übrigens an dem eingravierten Kreis mit der Doppelwelle und dem „mt“.

Stainless steel products to the highest standards

With the MT series you get products that have been manufactured according to our quality and design specifications and are thus exclusively available at Marinetechnik. With our own brand, we expand the stainless steel range with products that are not yet available on the market in this design. This can be, for example, a standard product from our range that we have manufactured from a higher quality material or in an additional size. But there are also MT products that have an entirely new function.

Meanwhile, the MT series counts more than 30 products. Every year when our novelties appear, we bring some new MT products to the market. So not only our assortment grows, but also our own brand. By the way, you can identify the MT series by the engraved circle with the double wave and the "mt".

Des produits en acier inoxydable conformes aux normes les plus strictes

Avec la série MT, vous obtenez des produits fabriqués selon nos critères de qualité et de design et donc exclusivement disponibles chez Marinetechnik. Avec notre propre marque, nous élargissons l'assortiment d'acier inoxydable avec des produits qui ne sont pas encore disponibles sur le marché sous cette forme. Il peut s'agir par exemple d'un produit standard de notre gamme que nous laissons fabriquer dans un matériau de meilleure qualité ou dans une taille supplémentaire. Mais il existe aussi des produits MT qui présentent une toute nouvelle fonction.

Entre-temps, la série MT compte plus de 30 développements propres. Chaque année, nous lançons également quelques nouveaux produits MT sur le marché avec nos nouveautés. Ainsi, ce n'est pas seulement notre assortiment qui s'agrandit, mais aussi notre propre marque. Celle-ci est d'ailleurs reconnaissable au cercle gravé avec la double vague et le "mt".

Productos de acero inoxidable de la más alta calidad

Con la serie MT, obtendrá productos que se han fabricado siguiendo nuestras especificaciones de calidad y diseño y que, por lo tanto, están disponibles exclusivamente en Marinetechnik. Con nuestra propia marca, ampliamos la gama de acero inoxidable con productos que aún no están disponibles en el mercado en esta forma. Puede tratarse, por ejemplo, de un producto estándar de nuestra gama que hemos fabricado con un material de mayor calidad o en un tamaño adicional. Pero también hay productos MT que tienen una función completamente nueva.

Mientras tanto, la serie MT cuenta con más de 30 desarrollos propios. Además, cada año lanzamos al mercado algunos productos MT nuevos con nuestras innovaciones. De este modo, no sólo crece nuestra gama, sino también nuestra propia marca. Por cierto, puede reconocerla por el círculo grabado con el doble eje y la "mt".

Produkty ze stali nierdzewnej spełniające najwyższe standardy

Dzięki serii MT otrzymujesz produkty, które zostały wyprodukowane zgodnie z naszymi specyfikacjami jakościowymi i projektowymi, a zatem są dostępne wyłącznie w Marinetechnik. Dzięki naszej własnej marce rozszerzamy asortyment stali nierdzewnej o produkty, które nie są jeszcze dostępne na rynku w tej formie. Może to być na przykład standardowy produkt z naszej oferty, który wyprodukowaliśmy z materiału wyższej jakości lub w dodatkowym rozmiarze. Istnieją jednak również produkty MT, które mają zupełnie nową funkcję.

W międzyczasie seria MT liczy ponad 30 własnych opracowań. Każdego roku wprowadzamy na rynek nowe produkty MT z naszymi innowacjami. W ten sposób rośnie nie tylko nasza oferta, ale także nasza własna marka. Nawiasem mówiąc, można ją rozpoznać po wygrawerowanym okręgu z podwójnym wałkiem i napisem "mt".

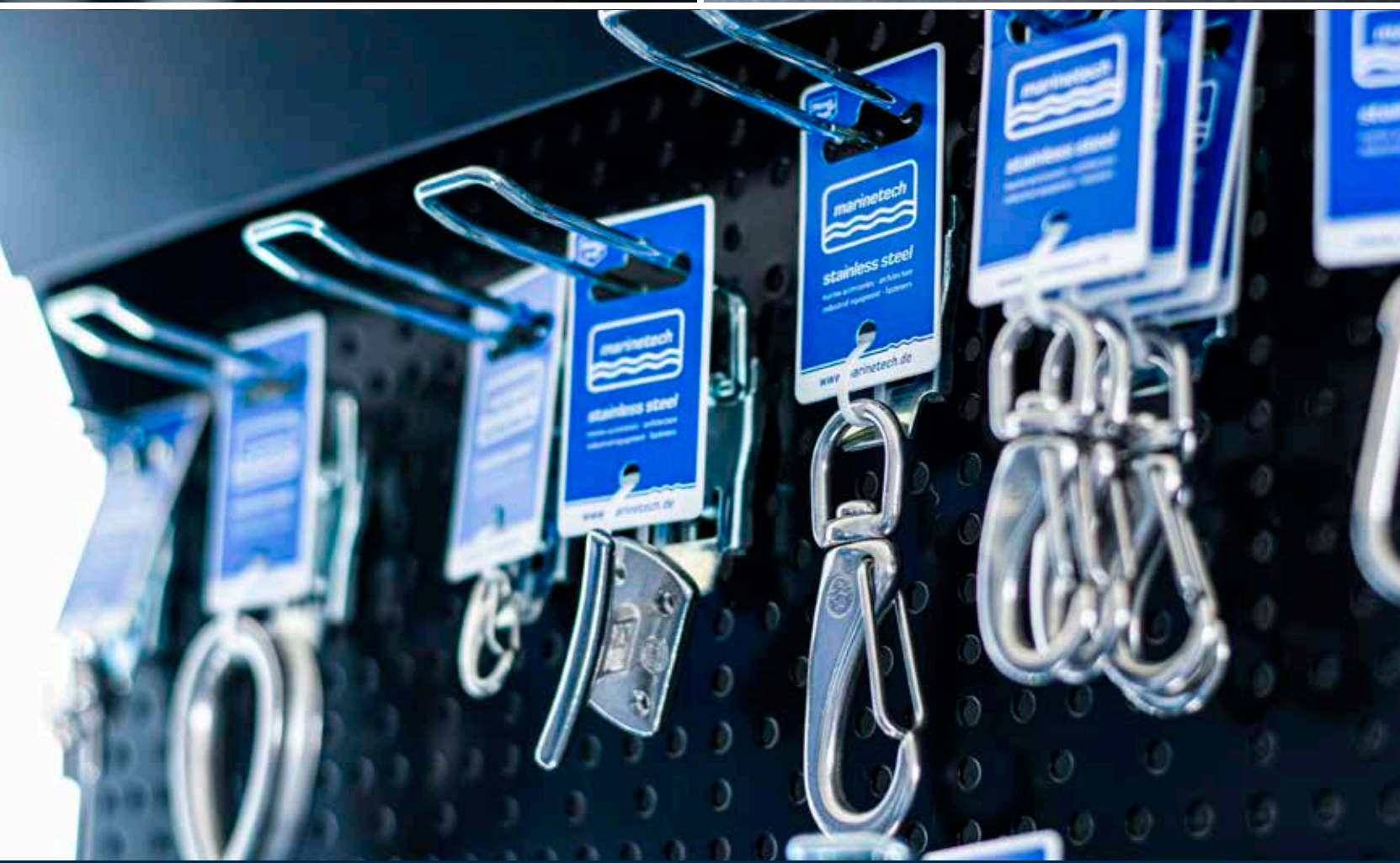



Index / Index / Indice

P. 12 - 66

Stichwortverzeichnis

Contents / Table des matières

Indice / Spis treści



P. 12



P. 17



P. 22



P. 27



P. 32



Kapitel 1 / Chapter 1 / Chapitre 1

P. 67 - 96

Schäkel, Karabinerhaken und Wirbel

Shackles, spring hooks and swivels

Manilles, mousquetons et émerillons



Kapitel 2 / Chapter 2 / Chapitre 2

P. 97 - 150

Spannschlösser, Terminals und Drahtseile

Turnbuckles, terminals and wire ropes

Tendeurs, ridoirs, embouts à sertir et câbles



Kapitel 3 / Chapter 3 / Chapitre 3

P. 151 - 166

Druckknopfsysteme

Snap fastening systems

Système de bouton à pression



Kapitel 4 / Chapter 4 / Chapitre 4

P. 167 - 212

Rohre, Relingsbeschläge, Scheuerleiste und Zubehör

Tubes, rail fittings, rub strakes and accessories

Tubes, embases, liston de protection et accessories



Kapitel 5 / Chapter 5 / Chapitre 5

P. 213 - 232

Ketten und Verbinder

Chains and connectors

Chaînes, maillons rapides et jonctions



Kapitel 6 / Chapter 6 / Chapitre 6

P. 233 - 302

Scharniere, Griffe, Haken und Ringe

Hinges, handles, hooks and rings

Charnières, poignées, crochets et anneaux

	Kapitel 7 / Chapter 7 / Chapitre 7	P. 303 - 356
	Klampen, Blöcke und Bolzen Cleats, blocks and bolts Taquets, poulies et cadènes	
	Kapitel 8 / Chapter 8 / Chapitre 8	P. 357 - 414
	Yachtzubehör, Ausrüstung und Spezielles Yachting accessories, equipment and highlights Équipement et accessoires exclusifs pour yachts	
	Kapitel 9 / Chapter 9 / Chapitre 9	P. 415 - 424
	Werkzeug, Reparatur und Pflege Tools, repair and maintenance Outils de réparations et de maintenance	
	Kapitel 10 / Chapter 10 / Chapitre 10	P. 425 - 438
	Fittings und Schellen Fittings and hose clamps Raccords et colliers	
	Kapitel 11 / Chapter 11 / Chapitre 11	P. 439 - 496
	Schrauben in SB-Verpackungen Screws in self-service packages Visserie sous blister en libre service	
	Kapitel 12 / Chapter 12 / Chapitre 12	P. 497 - 525
	Schrauben in Großpackungen Screws in bulk packs Visserie en gros conditionnement	



DE

A	Seite	B	Seite
Abdeckkappe für Steckdose	394	Bootshakenhalter	296
Angelrutenhalter	380 - 383, 396	Bootshakenspitze	398
Anker	222 - 223	Borddurchlass	426 - 427
Anker, Pilzform für Schlauchboot	224	Brummelhaken	83
Ankerausleger	228	Bügel	194 - 195
Ankergurtbandrolle	228	Bügelmuttern	353
Ankerkette	218	Bügelschrauben	353
Ankerkettenmarkierung	221	Bügelseilklemme	135, 142
Ankerkettenverbinder	226	Bügeltasche	195 - 196
Ankerrolle	227	Bugpuffer	401
Ankerwirbel	225 - 226	Bugrolle	227 - 228, 400
Ankerwirbel-Adapter	227	Bugspriet	79
Anlegefeder	393 - 394		
Anschweissende	114	C	
Antennenfuss	383, 384	C-Ring	222
Antennenhalter	383, 384	Curryklemmen, Sprenger	337
Anti-Rutschplatten	385		
Antikorrosionspaste	422	D	
Augbolzen	345 - 347, 349 - 351	D-Ring	297
Augbolzen, mit Holzgewinde	351	Decksbeschlag	209
Augbügel	197	Decksdurchführung	413
Auge mit Gewinde	116	Deckslüfter	373
Auge mit Gewinde "MINI"	117	Decksplatte	204 - 206
Auge, Holzgewinde	117	DOT Befestigungselemente	157 - 164
Augplatte	111, 205, 207 - 208	Drahtseiklampe	142
Augschrauben	108	Drahtseil	125 - 130
Augschrauben, Duplex	108	Drahtseil-Klemmring	139
Augterminal	116	Drahtseil-Klemmstopper	137 - 139
Augterminal "MINI"	116	Drahtseil, PVC ummantelt	128
Augverschluss	209	Drahtseilführung	198
Auspuffdurchlass	377	Drahtseilklemme	136 - 137, 142
Aussenborderhalterung	404 - 405	Drahtseilklemme, Duplex	136
Aussenborderschloss	405	Drahtseilschere	147
		Durchlass, Tau oder Kette	224
B			
Babystagbeschlag	125	E	
Badeleiter	359 - 360	Eimer	358
Batterie-Haltegurt	201	Einfüllstutzen	377 - 378
Becher	397	Einfüllstutzen 30° mit versenkbarem Griff	378
Becherhalter	394 - 395	Einfüllstutzen mit versenkbarem Griff	377
Biminigelenk	190, 192 - 194	Einlassgriff	275 - 280
Biminispanner	191	Einschlagmutter	499
Bit-Sortiment	416	Endkappe	184, 191 - 192
Bithalter	417		
Bits	417	F	
Block	311, 341 - 343	Fallenaustritt	338
Blöcke, Sprenger	311, 316 - 337	Fanfare	413
Bodenanker	223	Federstecker	145 - 146
Bodenanker schwere Ausführung	223	Fenderauge	363
Bodenheber	275 - 280	Fenderhaken	362
Bojenhaken	402	Fenderhaken Einhand-Bedienung	363
Bojenkarabiner	76		
Bolzen	142, 145, 147		
Bootshaken	397 - 398		



F	Seite	H	Seite
Fenderhaken Pop-out	364	Haken mit Grundplatte	287
Fenderhalter	361, 364	Haken, S-Form	292 - 293
Fenderhalter, doppelt	361	Hakenschrauben	106 - 107
Fenderklampe	309	Hakenschrauben, Duplex	107
Fenderösen	196	Halbrundprofil	210
Fitting	428 - 432	Haltegriffverbinder	168
Fitting, Messing	432 - 435	Halteschelle	437
Flachbügel	197	Handgriff	300 - 302
Flachmann	397	Handlauf	301 - 302
Flaggenklampe	309 - 310	Handlauf Mittelstück	179
Flaggenstock	365 - 366	Handlaufdurchlass	178 - 181
Flaggenstock-Set	366	Handlaufendstück	179 - 182
Flaggenstockhalterung	367 - 368	Handlaufhalter	181
Flasche	396	Harpunenspitze	392
Flaschenhalter	395 - 396	Haubenhalter	275
Fleischerhaken	292 - 293	Hebelverschluss	269 - 274
Flügelmutter	349	Hebelverschluss, abschliessbar	273
Fokkernadel	146	Heckankerausleger	228
		Heckschutzplatte	406
		Holzgewindeterminale	113 - 114
		Horn	412
		Hornpoller	306
		Hülse "MINI"	113
		Hundeleinen-Haken	81 - 82
		I	
		Innengewindeterminale "MINI"	112
		Inspektionsflansch	368 - 369
		Inspektionsflansch, Kunststoff	369
		Isolierbecher	396 - 397
		K	
		Kabeldecksdurchführung	413
		Kabinenhaken	286
		Karabiner mit Wirbel	81 - 82
		Karabiner, doppelt	83
		Karabinerhaken	68 - 77, 82
		Karabinerhaken, ALU	70, 76, 78 - 81
		Karabinerhaken, doppelt	78
		Karabinerhaken, Simplex	76
		Kausche	132 - 133
		Kausche, Duplex	133
		Kausche, Nylon	134
		Keil, Sprenger	338
		Keilsicherungsscheiben	500 - 501
		Kette	218 - 221
		Kette, langgliedrig	219
		Kettenhaken	227
		Kettenklüse	224
		Kettenkralle	221
		Kettenmarkierung	221
		Kettennotglied	222
		Kettenschnellverschluss	74, 103



DE

K	Seite
Kettenstopper	224 - 225
Kielrollen	400
Kiemenblech	369 - 373
Kiemenblech, rund	371
Kistengriff	299
Klampe	304 - 307, 310
Klappauge	202 - 203
Klappbolzen	144
Klappdraggen	223
Klappsplint	145
Klavierband	234
Kleiderhaken	288 - 291
Klemmring	139
Klemmstopper	137 - 139
Klettscheiben für Poliermaschine	421
Klüse	224
Knotenkette	220
Kreuzklemme	137 - 138
Kugel mit Innengewinde "MINI"	149
Kugelschnapper	388
Kugelventil	428, 431

L	Seite
L-Haken	352
Laugaugenmutter	355
Laugaugenmutter, doppelt	355
Lasthaken, Duplex	229
Leinenrolle	365
Leitösen	197
Lenkradknauf	403
Lenzstopfen	399
Lichtmast	401
Linsenkopfhülse "MINI"	113
Linsenkopfterminal "MINI"	113
Lippklampe	310
Lüfter	373 - 374
Lüftungsblech	369 - 373
Lüftungsblech, rund	371 - 372
Lüftungsgitter	372
Lukenaufsteller	385
Lukenfederhalter	386
Lukenheber	275 - 280

M	Seite
Mastadapter für Angelrutenhalter	382
Mastplatte	204, 206
Maststufen	384
Messer	423 - 424
MINAX Befestigung	155 - 156
Minilenzler	374
Möbelknopf	285
Montageterminal	122 - 123
Montageterminal "MINI"	123

M	Seite
Motorhaubenscharnier	263
Multitool	424
Mutter, Wantenspanner	104

N	Seite
Netzanker	223
Notklampe	309

O	Seite
Ösenschraube	347 - 348, 352 - 353

P	Seite
Pelikanhaken	124
Perseningstütze	407
Pfortenstütze	169
Pilzanker	224
Planenknopf	196
Planenstütze	407
Plaster	419
Poliermaschine	421
Polierpaste, Acryl	422
Polierpaste, Edelstahl	422
Politur, Edelstahl	422
Poller	308
Polsterbefestigung	165
Pressbacken für Pressklemmen	148
Pressbacken für Terminals	148
Pressklemme	140
Pressklemme, ALU	141
Pressklemme, KUPFER	141
Presszange (hydraulisch)	148
Propeller-Schutzhülle	405
Prüfplakette, Duplex	231

R	Seite
Radar-Reflektor	385
Ratschen	202
Reffleinenrolle	343
Reling, T-Stück	176 - 177
Reling, T-Stück klappbar	176
Relinganschweissfuss	174 - 176
Relingfuss	169 - 173, 178, 186
Relingsdrahtset	130 - 131
Relingstütze	169
Relingverbindung	177 - 178
Reparaturband	420
ResQ-Plast	419 - 420
ResQ-Tape, Display	420
Rettungsleinenhalter	365
Riemenbügel	195
Ring, Doppelsteg	298



DE

T	Seite
T-Stück, klappbar	176
T-Terminal	118
Takelmesser	424
Tankentlüfter	375 - 376
Tauklemmen	310
Tauklemmen, Sprenger	337
Tauwerkhalter	295
Tauwerkschneider	358
Tenax	152 - 154
Terminal-Halteplatte für T-Form	118
Terminal, Auge	116
Terminal, Auge "MINI"	116
Terminal, Drehbar	118 - 119
Terminal, Gabel	119
Terminal, Gabel "MINI"	119
Terminal, Gabel gedrehte Ausführung	120
Terminal, Gewinde	110
Terminal, Gewinde "MINI"	111
Terminal, Holzgewinde	113 - 114
Terminal, Innengewinde "MINI"	112
Terminal, Linsenkopf "MINI"	113
Terminal, Selbstmontage	122 - 123
Terminal, Selbstmontage "MINI"	123
Terminal, Senkkopf "MINI"	113
Terminal, T-Form	118
Terminal, Toggle	120 - 121
Tikal TefGel	422
Tischplattenhalterung	386
Toggle	122
Toggle mit Gewinde	121
Toggle-Terminal	120 - 121
Trailerhaken	81
Trailerrollen	400
Trailerwinde	403
Transporttrolley	406
Triangel-Ring	298
Türhalter	388
Türhalter, magnetisch	388 - 390
Türriegel	282, 284, 381
Türschloss, magnetisch	391
Türschnapper	388
Türstopper	387
Türverschluss	391

U	Seite
U-Bolzen	343 - 345
U-Bolzen mit Abreissmuttern	344
U-Bolzen, schwere Ausführung	344
Überfallscharnier	267 - 270, 284
Universalschlüssel	418
Unterlegscheibe, Innengewinde	112

V	Seite
Verdeckauge	362
Verdeckbeschlag	188 - 190
Verkürzungsklaue, Duplex	230
Verschluss	267 - 270, 280 - 285, 386
Verschlussscharnier	281 - 282
4-Wege-Verbindung	178
Vorhängeschloss	390 - 391
Vorreiber	285

W	Seite
Wandkonsole "MINI"	149
Wantenspanner	98 - 101, 106
Wantenspannerhülsen	104
Wantenversteller	124
Wäscheleine	403
Wasserablauf	378 - 380
Wasserablauf mit Schlauchanschluss	379
Wasserauslass	379
Wasserauslass mit Edelstahlkappe	374
Wassereinlass	380, 427
Wassereinlass, Messing	434
Wasserhahn	431
Wasserskihaken	93, 403 - 404
Winch bit	418
Windenkurbel	402
Windhutze	368
Windrichtungsanzeiger	358
Winkel	293 - 294
Winkel, flach	294 - 295
Winsch	403
Wirbel	94 - 96
Wirbelschäkel	207
Wurfanker	223

Z	Seite
Zeising	398



A	Page
Air scoop	368
Anchor	222 - 223
Anchor boom	228
Anchor chain	218
Anchor chain connector	226
Anchor chain marking	221
Anchor roller	227
Anchor strap roller	228
Anchor swivel	225 - 226
Anchor swivel adapter	227
Anchor, mushroom-shaped for rubber boat	224
Antenna base	383, 384
Antenna mount	383, 384
Anti-corrosion paste	422
Arpaulin button	196
Ascenders	83
Assembly terminal	122 - 123
Assembly terminal "MINI"	123

B	Page
Babystay fittings	125
Backing plate	174
Ball catch	388
Ball valve	428, 431
Ball with internal threads "MINI"	149
Base plate	204 - 206
Battery belt	201
Belt bracket	195
Belt hook	198 - 199
Beverage holder	394 - 396
Bimini joint	190, 192 - 194
Bimini spanner	191
Bindings	398
Bit holder	417
Bit selection	416
Bits	417
Block	311, 341 - 343
Blocks, Sprenger	311, 316 - 337
Boat hook	397 - 398
Boat hook mount	296
Boat hook tip	398
Bollards	306, 308
Bolts	142, 145, 147
Bottle	396
Bottle holder	395 - 396
Bow cushion	401
Bow roller	227 - 228, 400
Bowsprit	79
Box handle	299
Bracket nuts	353
Bracket, strap	194 - 195
Brummel hook	83
Buckets	358
Buffing machine	421

B	Page
Buoy carabiner	76
Buoy hooks	402

C	Page
C-Ring	222
Cabin hooks	286
Cabinet knob	285
Cable deck bushing	413
Canvas support	407
Carabiner hook	68 - 77, 82
Carabiner hook, ALUMINUM	70, 76, 78 - 81
Carabiner hook, double	78
Carabiner hook, simplex	76
Carabiner with swivel	81 - 82
Carabiner, double	83
Chain	218 - 221
Chain claw	221
Chain hook	227
Chain marking	221
Chain stopper	224 - 225
Chain, long-link	219
Clamp	304 - 307, 310
Clamp ring	139
Clamp stop	137 - 139
Clothes hanger	288 - 291
Clothes line	403
Clutch bag	195 - 196
Contact spring	393 - 394
Corner brace	293 - 294
Corner brace, flat	294 - 295
Cotter pin	145 - 146
Cotters, foldable	145
Cover fittings	188 - 190
Cover for socket	394
Crimping pliers (hydraulic)	148
Cross clamp	137 - 138
Cup holder	394 - 395
Curry clamps, Sprenger	337

D	Page
D-Ring	297
Deck bracket	209
Deck bushing	413
Deck drain scupper with hose connection	379
Deck fan	373
Dog leash hooks	81 - 82
Dome case nut "MINI"	113
Door catch	388
Door holder	388
Door holder, magnetic	388 - 390
Door lock	282, 284, 381
Door lock, magnetic	391
Door stop	387



EN

D	Page
Doorlock	391
DOT Mounting elements	157 - 164
Draggen anchor	223
Drain plugs	399
Drive-in nut	499
Duplex connecting link	230

E	Page
Elastic rope holder	196
Elastic rope hooks	398
Emergency clamp	309
End cap	184, 191 - 192
Exhaust thru hull	377
Eye bolt	108, 117, 197, 345 - 349, 351 - 353
Eye bolts with threading "MINI"	117
Eye bolts with threads	116
Eye bolts, Duplex	108
Eye bolts, with wood threads	351
Eye plate	111, 205, 207 - 208
Eye terminal	116
Eyelet	209

F	Page
Fanfare	412 - 413
Fastening clamps	437
Faucet	431
Fender baskets	361, 364
Fender baskets, double	361
Fender cleat	309
Fender eye	363
Fender eyelets	196
Fender hook	362
Fender hook one-handed operation	363
Fender hook pop-out	364
Ferrule	140
Ferrule, ALUMINUM	141
Ferrule, COPPER	141
Filler neck	377 - 378
Finish, stainless steel	422
Fitting	428 - 430
Fitting, brass	432 - 435
Flag clamp	309 - 310
Flag pole set	366
Flagpole	365 - 366
Flagstaff mount	367 - 368
Flat clips	197
Flip bolt	144
Floor handle	275 - 280
Folding eye ring	202 - 203
Fork for winch retraction	194
Fork terminal	119 - 120
Fork terminal "MINI"	119
Fork with internal threads "MINI"	103, 104

F	Page
Fork with threading	101 - 103
Fork with threading "MINI"	103
Four 4-way joint	178

G	Page
Gable hooks	286
Gate support	169
Genoa sled	341
Genoa sled, Sprenger	339 - 340
Genoa tracks, Spenger	338
Gill plate	369 - 373
Gill plate, round	371
Grinding machine	421
Grip	300 - 301
Ground anchor	223
Guide loops	197

H	Page
Hand rail pass	178 - 181
Handle	300 - 302
Handle connectors	168
Handrail	301 - 302
Handrail center fitting	179
Handrail support	181
Hanger bolt "MINI"	115
Hard rail end section	179 - 182
Harpoon tip	392
Hatch handle	275 - 280
Hatch spring-loaded holder	386
Hatch stands	385
Hawse	224
Hawse pipe	224
Heavy duty bottom anchor	223
Hinge	234 - 267
Hinge, plastic	239
Hinge, weld-on	265 - 267
Hip flask	397
Holding hinge	261
Holding hinge with short leaves	262 - 263
Hood latch	275
Hook screws	106 - 107
Hook screws, Duplex	107
Hook with groundplate	287
Hooks	287, 295, 349
Hooks, S-form	292 - 293
Horn	412 - 413
Hose Clamp, heavy duty	438
Hose connector	430
Hose deck fill 30° with retractable handle	378
Hose deck fill with retractable handle	377
Identification Tag, Duplex	231
Inspection flange	368 - 369
Inspection flange, plastic	369



I	Page	N	Page
Insulated cups	396 - 397	Nut, Turnbuckle	104
Internal thread terminal "MINI"	112		
J		O	
Jib	78	Oarlock	413 - 414
K		Oarlock socket	414
Kedge anchor	223	Outboard lock	405
Key for shackle	91	Outboard mounts	404 - 405
Key ring	299	Overlapping hinge	267 - 270, 284
Keychain	390	P	
Kiel rollers	400	Padlock	390 - 391
Knife	423 - 424	Pan head terminal "MINI"	113
L		Pass, rope or chain	224
L-hooks	352	Pelican hook	124
Latch release	338	Piano hinges	234
Lever latch	269 - 274	Pipe	168
Lever latch, lockable	273	Pipe cap	184, 191 - 192
Lifeline holder	365	Pipe center piece	186 - 187, 192
Light mast	401	Pipe clamp	436
Linch pin	145	Pipe connector	169
Line roller	365	Pipe elbow	429
Lip clamp	310	Pipe end section	171 - 172, 178, 185, 186
Lock	267 - 270, 280 - 285, 386, 290	Pipe extension, end cap	185, 187
Lock with push button	392	Pipe fitting	171 - 172, 178, 186
Locking bolts	142, 147	Pipe mount, tarpaulin	172
Locking bolts with safety rope	147	Pipe quick-lock	169
Locking bolts, ball bearing	145	Plaster	419
Locking hinge	281 - 282	Polish, acrylic	422
Locking hook	401	Polish, stainless steel	422
Long-eyed nut	355	Pressure clamps for ferrules	148
Long-eyed nut, double	355	Pressure clamps for terminals	148
Low friction ring	135	Propeller cover	405
M		Protective sleeve, Propeller	405
Mast plate	204, 206	Q	
Mast steps	384	Quick chain link	74, 103
Meat hook	292 - 293	Quick chain links	222
MINAX mount	155 - 156	Quick coupling	431 - 432
Motor hood hinge	263	R	
Motor trolley	406	Radar reflector	385
Mug	397	Rail end section, Sprenger	339
Multi-tool	424	Railing base	169 - 173, 178, 186
Mushroom anchor	224	Railing connector	177 - 178
N		Railing stanchion	169
Net anchor	223	Railing welding base	174 - 176
Node chain	220	Railing wire set	131
Non-slip plates	385	Railing, T-section	176 - 177
		Railing, T-section foldable	176
		Ratchet	202
		Rear protection plate	406



EN

R	Page
Recessed grip	275 - 280
Reefing line pulley	343
Repair tape	420
ResQ-Plast	419 - 420
ResQ-Tape, display	420
Ring bolt, Duplex	230
Ring bolts	354
Ring nails	299
Ring nuts	353 - 354
Ring, bridge	298
Ring, double bridge	298
Ring, form C	222
Ring, form D	297
Ring, Oval, Duplex	231
Ring, round	296
Ring, square	297
Ring, triCorner brace	298
Ring, two-piece	299
Ringsplint	146, 494
Rod holders	380 - 383, 396
Rope clamps	310
Rope clamps, Sprenger	337
Rope cutter	358
Rope holder	295
Rope pulley, Sprenger	336
Rubber buffer	387
Rubber stop	398

S	Page
S-hooks	77, 292 - 293
Safety line	147
Safety ring	146, 494
Safety spring	146
Sail binding	398
Sash lock	285
Screw connectors	72, 74, 103
Screw connectors, square	74
Screw hook, metric	348
Screw hook, wood threads	352
Screw terminal "MINI"	123
Secure bolt, shackle	96
Semi-round profile	210
Shackle	84 - 92
Shackle key	91
Shackle, Duplex	229
Shackles, ALUMINUM	86
Sheet clamps, Sprenger	337
Sheet rope shackles	74, 93, 103
Shock absorber	393 - 394
Shortening clutch, Duplex	230
Shroud adjustor	124
Signal horn	412 - 413
Simplex carabiner hook	76
Skirting board	210

S	Page
Skirting board, scratch-stop	211
Skirting boards - end section	211
Sleeve "MINI"	113
Slide latch spring loaded with cover	283
Slide lock	282 - 283
Sling hook, Duplex	229
Sliphook	125
Snap hook	76
Snap hook, double	78
Snap hook swivel	82 - 83
Snap shackles	92 - 93
Snap-mount	165
Socket cover	394
Soft top eye	362
Spinnaker boom mount	365
Spiral hooks	348, 352, 398
Spray hood handrail brackets	182 - 183
Steel wire rope	125 - 130
Steel wire rope, PVC coated	128
Steering knob	403
Stern anchor boom	228
Strap brackets	194 - 195
Strap buckle	199, 200
Strap closure	200
Strap roller	228
Strap tensor	202
Sunken head terminal "MINI"	113
Sunshade system	410 - 412, 382
Swan neck	368
Swimming ladder	359 - 360
Swing chain	218
Swing hooks	348, 352
Swivel	94 - 96, 207
Swivel rings	195

T	Page
T-section	176 - 177
T-section foldable	176
T-terminal	118
Table top mount	386
Tackle knife	424
Tank bleeder	375 - 376
Tarpaulin support	407
Tenax	152 - 154
Tensor latch	271, 269 - 274
Tensor latch, lockable	273
Tensor strap	201 - 202
Tensor strap clasp	201
Terminal "MINI"	116
Terminal, eye	116
Terminal, eyebolt "MINI"	116
Terminal, fork	119
Terminal, fork "MINI"	119
Terminal, fork rotated model	120



T	Page	W	Page
Terminal, internal threads "MINI"	112	Washer, inside thread	112
Terminal, mounting plate for T-form	118	Water drain	378 - 380
Terminal, pan head "MINI"	113	Water drain with stainless steel cap	374
Terminal, rotatable	118 - 119	Water inlet	380, 427
Terminal, self-assembly	122 - 123	Water inlet, brass	434
Terminal, self-assembly "MINI"	123	Water ski hooks	93, 403 - 404
Terminal, sunken head "MINI"	113	Webbing buckle with thorn	200
Terminal, T-form	118	Wedge lock washers	500 - 501
Terminal, threaded "MINI"	111	Wedge, Sprenger	338
Terminal, threading	110	Weld-on end	114
Terminal, toggle	120 - 121	Winch	403
Terminal, wood threading	113 - 114	Winch bit	418
Thimble	132 - 133	Winch handle	402
Thimble, Duplex	133	Wind direction indicator	358
Thimble, plastic	134	Wing nut	349
Thread insert	500	Wire rope clamp	136 - 137, 142, 310
Thread terminal	110	Wire rope clamp ring	139
Threaded terminal "MINI"	111	Wire rope clamp stop	137 - 139
Threading RE + LI threading "MINI"	112	Wire rope clamp, Duplex	136
Thru hull	426 - 427	Wire rope cleat	142
Tikal TefGel	422	Wire rope cutters	147
Toggle	122	Wire rope guide	198
Toggle with threading	121	Wood thread terminal	113 - 114
Toggle-terminal	120 - 121		
Trailer hooks	81		
Trailer rollers	400		
Trailer winch	403		
TriCorner brace ring	298		
Tube holder	172		
Turnbuckle	98 - 101, 105 - 106		
Turnbuckle Hook-Hook with securing	106		
Turnbuckle sleeve	104, 109		
Turnbuckle sleeve "MINI"	104		
Turnbuckle sleeve, Duplex	109		
Turnbuckle sleeves	104		
Turnbuckle, Duplex	105		
U			
U rope clamp	135, 142		
U-Bolt, heavy duty	344		
U-bolts	343 - 345, 353		
U-bolts with sheer nuts	344		
Universal key	418		
Upholstery mount	165		
V			
Velcro discs for buffing machine	421		
Vent	374		
Ventilation grilles	372		
Ventilation plate	369 - 373		
Ventilation plate, round	371 - 372		
Ventilator	373 - 374		
Wall console "MINI"	149		



FR

A	Page	B	Page
Adaptateur pour jonction d'ancre	227	Boulons à œil	353
Aérateur	373 - 374	Bouteille	396
Aérateur de pont	373	Bouton pour bâche	196
Aération de réservoir	375 - 376	Bouton pour pare-battage	364
Amortisseur de proue	401	Bride de maintien de sangle	194
Ancre	222 - 223	Bride de tube	436
Ancre à filet	223	Brides de cordage	310
Ancre à lancer	223	Brides de corde	310
Ancre champignon	224		
Ancre de rive	223	C	
Ancre, en forme de champignon pour canot pneumatique	224	Câble	125 - 130
Anneau brisé	146, 494	Câble de sécurité	147
Anneau de sécurité	146, 494	Câble de sécurité avec goupille	147
Anneau en C	222	Câble souple à gaine PVC	128
Anneau en D	297	Cadenas	390 - 391
Anneau en triangle	298	Cadène avec doube plaque	344
Anneau forme C	222	Cadènes	343 - 345
Anneau repliable	202 - 203	Cadènes avec écrous inviolables	344
Anneau, barrette	298	Cage de ridoir fermée	104, 109
Anneau, barrette double	298	Cage de ridoir fermée « MINI »	104
Anneau, deux pièces	299	Cages de ridoir	104
Anneau, forme D	297	Cale, Sprenger	338
Anneau, rond	296	Chaîne	218 - 221
Anneau, triangle	298	Chaîne à maillons noués	220
Arceau de bimini	191	Chaîne d'ancre	218
Arrêt de chaîne	224 - 225	Chaîne, maillons longs	219
Arrêtoir de porte	387	Chandelier	169
Arrivée d'eau	380, 427	Chape de fixation pour bimini	194
Articulation bimini	190, 192 - 194	Chariot de génois	341
Assortiment d'embouts	416	Chariot de génois, Sprenger	339 - 340
Attache excentrique	269 - 274	Chariot transport	406
Attache excentrique, verrouillable	273	Charnière	234 - 267
Attache rapide de chaîne	74, 103	Charnière à piano	234
Axe pour ridoir	142	Charnière à tige	234
Axe pour ridoir repliable	144	Charnière de capot moteur	263
		Charnière de verrouillage	281 - 282
B		Charnière, à souder	265 - 267
Bague d'arrêt	137 - 139	Charnière, plastique	239
Bague d'arrêt pour câbles	137 - 139	Chaumard croisé	310
Bague de foc	78	Chrochet à viande	292 - 293
Bastingage, pièce en T repliable	176	Cisaille pour câble	147
Bastingage, pièce en T/T	176 - 177	Clé pour manille	91
Bastingage, pièce en T/T	176 - 177	Cliquets	202
Bitte d'amarrage	306, 308	Clou à anneau	299
Bloc	311, 341 - 343	Coinceurs curry, Sprenger	337
Bloque-porte	388	Coinceurs pour cordage, Sprenger	337
Bloque-porte magnétique	388 - 390	Col de cygne	368
Bloqueur de porte	388	Collier de capote	186 - 187, 192
Bloqueur de porte à bille	388, 399	Collier de fixation	437
Bouchon	184, 191 - 192	Collier de serrage	438
Bouchon de tube	184, 185, 187, 191 - 192	Compas à ressort	386
Boucle de sangle	199 - 201	Compas d'ouverture d'écouille	385
Boucle de sangle avec ardillon	200	Console murale « MINI »	149
Boule avec filetage intérieur « MINI »	149	Corne de signalisation	412 - 413



C	Page	E	Page
Cornet	412	Échelle de bain	359 - 360
Corps de tendeur	109	Écrou à anneau	355
Cosse	132 - 134	Écrou à anneau, double	355
Cosse-coeur en alu	135	Écrou à enfoncer	499
Coude	429	Écrou hexagonal	104
Coupe orins	358	Écrou papillon	349
Couteau	423 - 424	Écrous à anneau	353 - 354
Couteau marin	424	Écrous à œil	353
Couvercle de prise de courant	394	Écubier	224
Crépine passe-coque, laiton	434	Écubier de chaîne	224
Croc de palan	81	Embase de bastingage	171 - 172, 178, 186
Crochet	287, 295, 349	Embase de bastingage à souder	174 - 176
Crochet à émerillon	82 - 83	Embase pour tube	169 - 171, 173
Crochet à laisse	81 - 82	Embout à chape fixe	119 - 120
Crochet à œil, Duplex	229	Embout à chape fixe, avec filetage	101 - 103
Crochet à visser	348	Embout à chape fixe, avec filetage « MINI »	103
Crochet à visser, filetage bois	352	Embout à chape fixe, avec filetage intérieur « MINI »	103, 104
Crochet accélérateur	83	Embout à monter	122 - 123
Crochet coulissant	125	Embout à œil à sertir	116
Crochet d'auvent	362	Embout à œil fixe, avec filetage « MINI »	117
Crochet d'écluse	401	Embout à œil, fileté	116
Crochet de bouée	402	Embout à souder	114
Crochet de cabine	286	Embout de liston	211
Crochet de cabine	286	Embout de main courante	179 - 182
Crochet de chaîne	227	Embout de rail, Sprenger	339
Crochet de corde élastique	398	Embout de tube	171 - 172, 178, 185, 186
Crochet en L	352	Embout en T	118
Crochet en S	77, 292 - 293	Embout filetage bois	113 - 114
Crochet en spirale	348, 352, 398	Embout fileté	110
Crochet fixe sur platine	287	Embout fileté « MINI »	111, 119
Crochet œil sur platine	363	Embout pour vice	417
Crochet pélican	124	Embout, à monter soi-même	122 - 123
Crochet pliant	363	Embout, chape articulée	120
Crochet pour sangle	198 - 199	Embout, filetage	110
Crochet pour ski nautique	93, 403 - 404	Embout, filetage bois	113 - 114
Crochet pour vêtements	288 - 291	Embout, filetage long « MINI »	111, 119
Crochet simple	362	Embout, forme T	118
Crochet tempête	286	Embout, fourche	119
Crochet vis	107	Embout, œil	116
Crochet, forme en S	292 - 293	Émerillon	94 - 96
		Enrouleur de cordage	365
		Enrouleur de sangles d'ancrage	228
		Épingle de sécurité	146
		Équerre	293 - 294
		Étai de bâche	407
		Étai Persenning	407
		Étrier de sangle	194 - 195
		Étrier plat	195
		Étrier, sangle	194 - 195
		Évacuation d'eau	378 - 380
		Évacuation pour Cockpit	379
		Event	374

D

Dalot pour coqueron	374
Dame de nage	413 - 414
Davier de proue	227 - 228, 400
Delphinière	79
Démanilleur	91
Disques à velcro pour polisseuse	421
DOT éléments de fixation	157 - 164
Douille « MINI »	113



FR

F

	Page
Fanfare	413
Fermeture	267 - 270, 284, 280 - 285, 386, 391
Fermeture sautерelle	271, 269 - 274
Fermeture targette à ressort	283
Fermeture tournante	285
Fil à linge	403
Filoir pour cordage	198
Fixation à clip	165
Fixation à œil	209
Fixation d'antenne	383, 384
Fixation de garniture	165
Fixation de tube	171 - 172, 178, 186
Fixation MINAX	155 - 156
Fixation pour hors-bord	404 - 405
Fixation pour main courante	181
Fixation pour tube	168
Flasque	397

G

Gaffe	397 - 398
Girouette	358
Gobelet	397
Gobelet thermos	396 - 397
Goupille	142, 145, 147
Goupille à bille	145
Goupille beta	145 - 146
Goupilles repliables	145
Grappin pliant	223
Griffe de racc, Duplex	133, 136, 230 - 231
Griffe de racc	96, 294 - 295, 297
Griffe pour chaîne	221
Grille d'aération	369 - 373
Grille d'aération à lamelle	369 - 373
Grille d'aération à lamelles, ronde	371
Grille d'aération, ronde	371 - 372

H

Hampe lumineuse	401
-----------------	-----

I

Insert de pont	500
----------------	-----

J

Jonction caïne-ancre	226
Jonction pour ancre	225 - 226

K

Kit d'ascension	83
Kit de mât de pavillon	366
Kit pour filière bastingage	131

L

Latte ridoir	124
Liston de protection	210
Liston de protection, anti-rayures	211
Loquet à cadenas	267 - 270, 284,

M

Mâchoires à sertir pour embouts	148
Mâchoires de serrage pour pinces de sertissage	148
Maille de tête ovale, Duplex	231
Maille de tête ovale, Möbelknopf	285
Maille de tête ovale, Sonnensegelsystem	410 - 412, 382
Maille de tête ovale, Tenax	152 - 154
Maille de tête ovale, Clé universelle	418
Maillon de chaîne de secours	222
Maillon de jonction, Duplex	230
Maillon rapide à visser	72, 74, 103
Main courante	301 - 302
Main courante de capote	182 - 183
Mamelon avec filetage D et G « MINI »	112
Manche à air	368
Manchon	140
Manchon, ALU	141
Manchon, CUIVRE	141
Manille	84 - 92
Manille à émerillon	92 - 93
Manille, ALU	86
Manille, Duplex	229
Manivelle de treuil	402
Marquage de chaîne	221
Marquage de chaîne d'ancre	221
Mousqueton à émerillon	76, 207
Mousqueton à émerillon, double	78
Mousqueton d'écoute	74, 93, 103
Mousqueton de bouée	76
Mousqueton de pompier, double	83
Mousqueton pompier	68 - 77, 82
Mousqueton pompier avec émerillon	81 - 82
Mousqueton pompier Simplex	76
Mousqueton pompier, ALU	70, 76, 78 - 81
Mousqueton pompier, double	78
Mousqueton pompier, Simplex	76
Multitool	424

N

Nable carburant coudée 30° ouverture avec bouchon a levier	378
Nable carburant ouverture avec bouchon a levier	377
Nable pour carburant	377 - 378

O

Obturateur	368 - 369
Obturateur, plastique	369
Oeillets de guidage	197



O	Page	Q	Page
Oeillets de pare-battage	196	Queue-de-cochon	348, 352
P		R	
Pas de mât	384	Raccord	428 - 430
Passage de câble sur le pont	413	Raccord à 4 voies	178
Passage de main-courante	178 - 181	Raccord à visser, carré	74
Passage main courante	179	Raccord de bastingage	177 - 178
Passage pour tube	172	Raccord de tube	169
Passage, corde ou chaîne	224	Raccord de tuyau	430
Passe-coque	426 - 427	Raccord rapide	431 - 432
Passe-coque d'échappement	377	Raccords, laiton	432 - 435
Pâte anticorrosion	422	Rail de génôis, Sprenger	338
Pâte de polissage, pour acrylique	422	Réa, Sprenger	336
Pâte de polissage, pour inox	422	Réfecteur radar	385
Pied d'antenne	383, 384	ResQ-Plast	419 - 420
Pince à sertir (hydraulique)	148	ResQ-Tape, Distributeur	420
Piton à œil	117, 345 - 347, 349 - 351	Ressort de mouillage	393 - 394
Piton à œil, avec filetage bois	351	Ridoir	98 - 101, 106
Piton d'amarrage	223	Robinet	431
Plaque d'ancrage pour embout en T	118	Rondelle, filetage intérieur	112
Plaque de protection poupe	406	Rondelles de sécurité	500 - 501
Plaques antidérapantes	385	Rotection de prise de courant	394
Plateau	174	Rouleaux de palan	400
Platine à anneau	111, 205, 207 - 208	Rouleaux de quille	400
Platine de capote	188 - 190, 209	Ruban adhésif de réparation	420
Platine de mât	204, 206	S	
Platine de pont	204 - 206	Sandow avec crochets,	398
Platine de pontet	195 - 196	Sandow pour voile	398
Platine stag baby	125	Sangle	201 - 202
Poignée	300 - 302	Sangle de maintien de batterie	201
Poignée d'accès	275 - 280	Sauterelle, verrouillable	273
Poignée de hublot	275 - 280	Seau	358
Poignée de malle	299	Serre-câbles	136 - 137, 139, 142
Poignée de volant	403	Serre-câbles à croix	137 - 138
Poignée pour trappe de sol	275 - 280	Serre-câbles à étrier	135, 142
Pointe de gaffe	398	Serre-câbles rond	139
Pointe de harpon	392	Serrure à bouton-poussoir	392
Polish, pour inox	422	Serrure de porte magnétique	391
Polisseuse	421	Sortie de drisse	338
Pontet plat	197	Sparadrap	419
Porte pare-battage	361, 364	Sprenger boucle pour sangle	200
Porte pare-battage, double	361	Support d'ancre	228
Porte taquet	309	Support d'ancre arrière	228
Porte-boisson	394 - 396	Support de bouteille	395 - 396
Porte-clés	299, 390	Support de canne à pêche	380 - 383, 396
Porte-embout	417	Support de capot	275
Porte-fanion	365 - 366	Support de cordage	295
Porte-gobelet	394 - 395	Support de dame de nage	414
Poulie avec collier de serrage	343	Support de mât de pavillon	367 - 368
Poulie de cordage	365	Support de porte	169
Poulies, Sprenger	311, 316 - 337	Support de spinnaker	365
Profil demi-rond	210	Support de table	386
Protection d'hélice	405		

S	Page	W	Page
Support de tube, Persenning	172	Wunsch	403
Support pour bateau	296		
T			
T repliable	176		
Tampon en caoutchouc	387		
Taquet	304 - 307, 309 - 310		
Taquet de cordon élastique	196		
Taquet pour câble	142		
Taquet pour pavillon	309 - 310		
Taquets coinçeurs, Sprenger	337		
Tendeur	100, 105		
Tendeur crochet-crochet avec barrettes de sécurité	106		
Tendeur de sangle	202		
Tendeur Duplex	105		
Tendeur en caoutchouc	398		
Terminaison toggle	120 - 121		
Terminaison à filetage intérieur « MINI »	112		
Terminaison à monter « MINI »	123		
Terminaison à œil « MINI »	116		
Terminaison à tête bombée « MINI »	113		
Terminaison à tête fraisée « MINI »	113		
Terminaison à visser « MINI »	123		
Terminaison rotative	118 - 119		
Terminaison TBHC « MINI »	113		
Terminaison, à monter soi-même « MINI »	123		
Terminaison, filetage intérieur « MINI »	112		
Terminaison, œil « MINI »	116		
Terminaison, tête bombée « MINI »	113		
Terminaison, tête fraisée « MINI »	113		
Terminaison, toggle	120 - 121		
Tikal TefGel	422		
Toggle	122		
Toggle avec filetage	121		
Traversée de pont	413		
Treuil de halage	403		
Treuil embout	418		
Tube	168		
Tube avec goupille	169		
V			
Vanne sphérique	428, 431		
Verrou	282 - 283		
Verrou à clé pour hors-bord	405		
Verrou de porte	282, 284, 381		
Vis à anneau	354		
Vis à anneau, Duplex	230		
Vis à crochet	106 - 107		
Vis à œil	108		
Vis à œil, Duplex	108		
Vis à oeillet	347 - 348, 352 - 353		
Vis sans tête « MINI »	115		



A	Página	B	Página
Abrazadera de perno de pivote	438	Baby stay	125
Abrazadera de sujeción con inserto de goma	437	Banda de tensión	201 - 202
Abrazadera de tubo	436	Barandilla	301 - 302
Abrazaderas de levas, rociador	337	Bauprés	79
Activación	122	Bichero	397 - 398
Adaptador de la espiral del ancla	227	Bisagra	234 - 267
Adhesivo de inspección, dúplex	231	Bisagra de cierre	281 - 282
Ajustador del obenque	124	Bisagra de pestillo	267 - 270, 284,
Alabante	310	Bisagra de piano	234
Alineador de escotilla	385	Bisagra de varilla	234
Amortiguador	393 - 394	Bisagra del compartimento del motor	263
Amortiguador de goma	387	Bisagra, plástico	239
Ancla	222 - 223	Bisagra, soldable	265 - 267
Ancla de piso	223	Bitá	306
Ancla de red	223	Bloque	311, 341 - 343
Ancla de seta	224	Bloqueo de cable	135, 142
Ancla de suelo	223	Bloques, rociador	311, 316 - 337
Ancla, ancla plegable	223	Bocina	412
Ancla, forma de seta para el bote	224	Bocina de alarma	412 - 413
Anclote	223	Bola con rosca interna «MINI»	149
Ángulo	293 - 294	Bolsa de proa	195 - 196
Ángulo, plano	294 - 295	Botella	396
Anillo de bloqueo	139	Botón lona	196
Anillo de bloqueo del cable de acero	139	Brazo del ancla	228
Anillo de sujeción	146, 494	Brazo del ancla de popa	228
Anillo en C	222	Brida Bisagra	186 - 187, 192
Anillo en D	297	Brida de inspección	368 - 369
Anillo triangular	298	Brida de inspección, plástico	369
Anillo, angular	297		
Anillo, doble pasarela	298	C	
Anillo, dos piezas	299	Cable de seguridad	147
Anillo, forma en C	222	Cable metálico	125 - 130
Anillo, forma en D	297	Cable metálico, revestido de PVC	128
Anillo, ovalado, dúplex	231	Cabrestante	403
Anillo, pasarela	298	Cabrestante para remolque	403
Anillo, redondo	296	Cadena	218 - 221
Anillo, triángulo	298	Cadena anudada	220
Arandela de seguridad estrecha	500 - 501	Cadena del ancla	218
Arandela, rosca interna	112	Cadena, fina	219
Argolla de escota	74, 103	Cadenote plegable	202 - 203
Argollas	84 - 92	Cáncamo	347 - 348, 352 - 353
Argollas de encaje	92 - 93	Cáncamo largo forjado	355
Argollas de escota	93	Cáncamo largo forjado, doble	355
Argollas, ALU	86	Cáncamos, dúplex	108
Argollas, Duplex	229	Candado	390 - 391
Armellas	345 - 347, 349 - 351	Carro de Génova	341
Armellas, con rosca de madera	351	Carro de Génova, rociador	339 - 340
Articulación bimini	190, 192 - 194	Carro de Transporte fueraborda	406
Asa	300 - 301	Casquillo	140
Ascendedor	83	Casquillo «MINI»	113
		Casquillo de cabezal lenticular «MINI»	113
		Casquillo, ALU	141
		Casquillo, COBRE	141
		Cerradura	390



ES

C	Página
Cerradura con botón	392
Cerradura de la puerta, magnética	391
Cerradura fuera de borda	405
Cerrojo	271, 269 - 274
Cerrojo deslizante	282 - 283
Chapa de protección de la popa	406
Cierre	267 - 270, 280 - 285, 386, 391
Cierre capó	275
Cierre de la banda de tensión	201
Cierre de palanca	269 - 274
Cierre de palanca, con cerradura	273
Cierre rápido de tubo	169
Cierre Sprenger para correa	200
Cierre tensor, con cerradura	273
Cinta de reparación	420
Cinta ResQ	420
Cinta ResQ-plast	419
Cinta ResQ, pantalla	420
Cizalla para cables	147
Clarín	413
Clavija hendida de anillo	146, 494
Clavo anular	299
Clip para cable de acero con ojo	142
Codo de tubería	429
Conector de cadena de ancla	226
Conector de empuñadura	168
Conector de tubo	169
Conector rápido	431 - 432
Conector roscado	72, 74, 103
Conector roscado, cuadrado	74
Conector, dúplex	230
Conexión de tubería	171 - 172, 178, 186
Conexión de tuberías	428 - 430
Conexión de tuberías, latón	432 - 435
Conexión para mangueras	430
Consola de pared «MINI»	149
Contraplaca	174
Corchete de la defensa	196
Cordaje	398
Cordaje para vela	398
Cornamusa	304 - 307, 309 - 310
Cornamusa de emergencia	309
Cornamusa de la bandera	309 - 310
Correa de la batería	201
Cortador de jarcias	358
Cubierta de enchufes	394
Cubo	358
Cuchilla	423 - 424
Cuchilla para aparejo	424
Cuello de cisne	368
Cuerda del tendadero	403
Cuña, rociador	338

D	Página
Desagüe	374, 378 - 380
Destorcedor	207
Discos de velcro para pulidora	421

E	Página
Ejecución de la cubierta	413
Ejecución de la cubierta del cable	413
Elementos de fijación DOT	157 - 164
Enganche de amarra	310
Enganche de amarra, rociador	337
Enganches de escota, rociador	337
Entrada de agua	380, 427
Escalera	359 - 360
Escarpiá roscada, rosca de madera	348, 352
Escobén	224
Escobén de la cadena	224
Eslabón de seguridad de cadena	74, 103
Espiral	94 - 96
Espiral del ancla	225 - 226
Estríbo con ojo	197
Estríbo de correa	194
Estríbo para correa	194 - 195
Estríbo plano	197
Estríbo, correa	194 - 195
Estuche del tensor de obenque	104
Etapas del mástil	384

F	Página
Fijación de almohadilla	165
Fijación de encaje	165
Fijación MINAX	155 - 156
Funda protectora de la hélice	405
Funda protectora, hélice	405

G	Página
G para la correa del perro	81 - 82
Gancho	287, 295, 349
Gancho Con Placa Base	287
Gancho de boya	402
Gancho de cabina	286
Gancho de cabina	286
Gancho de cadena	227
Gancho de carga, dúplex	229
Gancho de correa	198 - 199
Gancho de esclusa	401
Gancho de la defensa	364
Gancho de la defensa	362
Gancho de tormenta	286
Gancho en espiral	348, 352, 398
Gancho en S	77, 292 - 293
Gancho Fender	363
Gancho oscilante	348, 352



G	Página	M	Página
Gancho para cuerda elástica	398	Marca de la cadena del ancla	221
Gancho para esquíes	93, 403 - 404	Mástil de la bandera	365 - 366
Gancho para remolque	81	Mini Lenzer	374
Gancho Pelicano	124 - 125	Mosquetón con espiral	81 - 82
Gancho, forma en S	292 - 293	Mosquetón de boya	76
Ganchos de encaje	76, 82 - 83	Mosquetón, doble	83
Ganchos de encaje, dobles	78	Mosquetones	68 - 77, 82
Ganchos de metal	83	Mosquetones simplex	76
Garra de acortamiento, dúplex	230	Mosquetones, ALU	70, 76, 78 - 81
Gaza de goma	398	Mosquetones, dobles	78
Gncho en L	352	Mosquetones, simplex	76
Golpete para puertas	388	Multiherramienta	424
Golpete para puertas, magnético	388 - 390		
Grifo	431	N	
Guardacabo dúplex	133	Noray	308
Guardacabo redondo	135	O	
Guardacabos	132 - 134	Ojo con rosca	116
H		Ojo con rosca «MINI»	117
Hebilla	199, 200	Ojo con rosca madera	117
Hebilla de cinturón con punta	200	Ojo cubierto	362
Herraje de cubierta	209	Ollaos de guía	197
Herraje del puente	188 - 190	P	
Horquilla	413 - 414	Panel de ventilación	369 - 373
Horquilla con rosca	101 - 103	Panel de ventilación, redondo	371 - 372
Horquilla con rosca «MINI»	103	Panel ranurado	369 - 373
Horquilla con rosca interna «MINI»	103, 104	Panel ranurado, redondo	371
Horquilla para alojamiento del cabrestante	194	Pasacables de cuerda	198
I		Pasacabo	363
Indicador de la dirección del viento	358	Pasacascos, plastico	426 - 427
Inserto roscado	500	Pasador de chaveta	146
K		Pasador abatible	145
Kit de cableado de la escotilla	131	Pasador de chaveta	142, 145 - 147
Kit del mástil de la bandera	366	Pasador de chaveta con cable de seguridad	147
L		Pasadores, abatibles	145
Latón/entrada de agua, latón	434	Pasamano	178 - 181
Lijadora	421	Pasamanos pieza central	179
Llave para argollas	91	Paso de escape	377
Llave para argollas	91	Paso, amarra o cadena	224
Llave Universal	418	Pasta anticorrosiva	422
Llavero	299, 390	Pasta de pulido, acero	422
M		Pasta de pulido, acrílica	422
Mango	300 - 302	Pecha para cinturón	195
Mango para cajas	299	Percha para correa	195
Manivela del cabrestante	402	Perchero	288 - 291
Marca de la cadena	221	Perfil semicircular	210
		Perno	142, 145, 147
		Perno de ojo	209
		Perno de seguridad, grillete	96
		Perno de sustentación «MINI»	115
		Perno plegable	144



ES

P	Página
Pernos de gancho, dúplex	107
Pernos en U	343 - 345
Pernos en U con tuercas antirrobo	344
Pestillo	283
Pestillo de puerta	282, 284, 381
Pestillo para puerta	388
Petaca	397
Pie de antena	383, 384
Pie de barandilla	169 - 173, 178, 186
Pie de soldadura de la barandilla	174 - 176
Pieza final de la barandilla	179 - 182
Pieza final de los rieles, rociador	339
Pieza final del rodapié	211
Pieza final del tubo	171 - 172, 178, 185, 186
Pieza roscada DER + rosca IZQ «MINI»	112
Pinza cruzada	137 - 138
Pinza de la cadena	221
Pinza del cable metálico	136 - 137, 142
Pinzas de presión (hidráulicas)	148
Placa con ojo	111, 205, 207 - 208
Placa de cubierta	204 - 206
Placa de soporte del terminal para la forma en T	118
Placa del mástil	204, 206
Placas antideslizantes	385
Polea de la cuerda	365
Polea, rociador	336
Pomo de mueble	285
Pomo del timón	403
Portabebidas	394 - 396
Portabrocas magnético 1/4 "	417
Portacañas	380 - 383, 396
Portatubos, lona	172
Portavasos	394 - 395
Predistribuidor	78
Prolongación del tubo, tapa de extremo	185, 187
Pulido, acero	422
Pulidora	421
Púlpito de proa	227 - 228, 400
Punta de acero inoxidable 1/4 "	417
Punta de Gancho para cable	398
Punta del arpón	392
Purgador del depósito	375 - 376

R

Reflector del radar	385
Rejillas de ventilación	372
Resbalón de bola	388
Resorte de ajuste	393 - 394
Rieles de Génova, rociador	338
Rodapié	210
Rodapié, reparador de arañazos	211
Rodillo de matafiones	343
Rodillo para ancla	227
Rodillo para correa de ancla	228

R

R	Página
Rodillos de quilla	400
Rodillos para remolque	400
Rodillo para correa	228

S

Salida de agua	379
Salida de driza	338
Sistema de vela solar	410 - 412, 382
Soldado	114
Soporte de barandilla de capota contra salpicaduras	182 - 183
Soporte de cubierta	407
Soporte de cuerda	295
Soporte de defensa	361, 364
Soporte de la antena	383, 384
Soporte de la barandilla	181
Soporte de la cuerda de salvamento	365
Soporte de la defensa, doble	361
Soporte de la puerta	169
Soporte de lona	407
Soporte de muelles de escotilla	386
Soporte de spinnaker	365
Soporte de tubo	172
Soporte del bichero	296
Soporte del motor fueraborda	404 - 405
Soporte para cuerda elástica	196
Soporte para tableros de mesa	386
Soportes de barandilla	169
Sujeción del mástil de la bandera	367 - 368
Sujetacables	310
Sujetacables / Clip para cable de acero, dúplex	136
Surtido Bit	416

T

Tapa de extremo del tubo	184, 191 - 192
Tapa para enchufe	394
Tapón de registro	399
TefGel de Tikal	422
Tela metálica	222
Tenax	152 - 154
Tenazas de prensado para terminales	148
Tensor	105 - 106
Tensor bimini	191
Tensor de correa	202
Tensor de obenque	98 - 101, 106
Tensor Duplex	105
Tensores	100
Terminal de activación	120 - 121
Terminal de cabezal avellanado «MINI»	113
Terminal de cabezal lenticular «MINI»	113
Terminal de horquilla	119 - 120
Terminal de horquilla «MINI»	119
Terminal de montaje	122 - 123
Terminal de montaje «MINI»	123



K	Strona
Knaga	142, 304 - 307, 310
Knaga awaryjna	309
Knaga flagowa	309 - 310
Knaga otwarta	310
Knaga, poler cumowniczy	306
Knagi do szotów Sprenger	337
Kolanko rury	429
Kołnierz inspekcyjny	368 - 369
Kołnierz inspekcyjny, tworzywo sztuczne	369
Kołpak odpowietrzający	368
Końcówka do przyspawania	114
Końcówka do zawalcowania "MINI" głowica soczewka	113
Końcówka do zawalcowania "MINI" z gwintem prawym wew.	112
Końcówka do zawalcowania hakowa T	12
Końcówka do zawalcowania linki "MINI"	118
Końcówka do zawalcowania liny gwint prawy	110 - 111, 120 - 121
Końcówka do zawalcowania, widełki przegubowe	120 - 121
Końcówka imbusowa "MINI" z gwintem wew.	113
Końcówka oczkowa do zawalcowania "MINI"	116
Końcówka oczkowa "MINI" z gwintem wew.	117
Końcówka rury	184, 191 - 192
Końcówka skręcana do zawalcowania "MINI" z gwintem wew.	123
Końcówka widełkowa "MINI" z gwintem prawym	103
Końcówka widełkowa "MINI" z gwintem wew.	103, 104
Końcówka widełkowa do zawalcowania	116, 118 - 120
Końcówka widełkowa do zawalcowania linki "MINI"	119
Końcówka widełkowa z gwintem prawym	101 - 103
Końcówka z gwintem prawym, widełki przegubowe	121
Konsola ścienna "MINI"	149
Korba	402
Wciągarz	403
Korek rozporowy zamykający	399
Kotwica	222 - 223
Kotwica sieciowa	223
Kotwica zarzucana	223 - 224
Kotwica, forma grzybkowa dla pontonów	224
Kran	431
Kratka wentylacyjna	369 - 373
Kratka wentylacyjna, okrągła	371
Krętlik	94 - 96
Krętlik kotwicy	225 - 226
Krętlik szekla-szekla	207
Kubek	397
Kubek termiczny	396 - 397
Kula z gwintem wewnętrznym "MINI"	149

L	Strona
Łącznik kotwiczny	226
Łącznik relingu	176 - 177
Łącznik rurowy trójnik	176 - 177
Łącznik rury	169
Łącznik śrubowy	72, 74, 103
Łącznik uchwytu	168, 368
Lampa na elastycznej szyjce	368

L	Strona
Łańcuch	218 - 221
Łańcuch nierdzewny ogniwo długie	219
Łańcuch węzłowy	220
Lina stalowa nierdzewna	125 - 130
Lina stalowa, w oplocie PVC	128
Lina zabezpieczająca	147
Linka na pranie	403
Lista odbojowa	211
Listwa odbojowa	210

M	Strona
Maszt flagi	365 - 366
Mocowanie MINAX	155 - 156
Mocowanie relingu	179
Mocowanie tapicerki	165
Mocowanie zapadkowe	165
Modułowy system daszka Bimini	410 - 412, 382

N	Strona
Nakrętka	104, 499
Nakrętka "MINI"	104
Nakrętka motylkowa	349
Nakrętka oczkowa długa	355
Nakrętka oczkowa długa, podwójna	355
Nakrętka pałaka	353
Nakrętka ściągacza , rzymska	104, 109
Nakrętka ściągacza becza	353
Nakrętka z uchem	353 - 354
Napinacz daszka bimini	191
Napinacz pasa	202
Napinacz wantowy	98 - 101, 106
Narzędzie wielofunkcyjne	424
Nastawnik wantowy	124
Nóż	423 - 424
Nóż takielunku	358
Nóż żeglarski	424
Nożyce do liny stalowej	147

O	Strona
Obejma rury	436
Oczko z gwintem	116
Odbój dziobu	401
Odbojnik gumowy	387
Odplyw	374
Odplyw wody	378 - 380
Odpowietrzenie zbiornika paliwa	375 - 376
Ogniwo kwadratowe	297
Ogniwo łańcucha	222
Ogniwo owalne Duplex	231
Ogniwo skrecane kwadratowe	74
Ogniwo złączeniowe	230
Ogranicznik otwarcia drzwi	388



PL

O

	Strona
Okno do śrub rzymskich Duplex	108
Okucie małego sztagu	125
Okucie pokładowe	188 - 190
Okucie pokładu	209
Okucie rury	171 - 172, 178, 186
Opaski	438
Opaski/ Obejma z gumą	437
Ośłona przejść burtowych	374
Owiewka wiatrowa uchwytu poręczy	182 - 183
Oznaczenie łańcucha	221
Oznaczenie łańcucha kotwicy	221

P

Pałak pasa	194 - 195
Pałak płaski	197
Pałak z uchem	197
Pałak, taśma pasa	194 - 195
Pas napinający	201 - 202
Pasek mocujący na baterię	201
Pasta antykorozyjna	422
Pasta do polerowania do stali nierdzewnej	422
Pasta polerska do akrylu	422
Pierścień C	222
Pierścień D	297
Pierścień na klucze	299
Pierścień pętla	198
Pierścień trójkątny	298
Pierścień zaciskowy	139
Pierścień zaciskowy liny stalowej	139
Pierścień, dwuczęściowy	299
Pierścień, forma C	222
Pierścień, forma D	297
Pierścień, kładka	298
Pierścień, kładka podwójna	298
Pierścień, okrągły	296
Pierścień, trójkąt	298
Piersiówka	397
Plakietka metalowa Duplex	231
Płyta dociskowa	174
Płyta osłony rufy	406
Płytki z uchem	111, 205, 207 - 208
Płyty antypoślizgowe	385
Podkładka z gwintem wewnętrznym	112
Podkładki HEICO-LOCK wąskie	500 - 501
Podnośnik	275 - 280
Podpora plandeki	407
Podwieź	204 - 206
Pokrowiec brezentowy	407
Pokrowiec śruby	405
Pokrywa gniazdka	394
Poler	308
Polerka	421
Politura do stali nierdzewnej	422
Poręcz	301 - 302

P

	Strona
Profil półokrągły	210
Przedłużenie rury, zakrętka końcowa	185, 187
Przegub daszka bimini	190, 192 - 194
Przeście burtowe	426 - 427
Przelotka	196
Przepust poręczy	178 - 181
Przepust rury wydechowej	377
Przepust, lina lub łańcuch/kluzo	224
Przycisk plandeki	196
Przyłącze węży	430

R

Raksa	78
Reflektor radarowy	385
Reling, teownik składany	176
ResQ - bandaż	419
ResQ-Tape	420
ResQ-Tape, wyświetlacz	420
Rolka dziobowa	227 - 228, 400
Rolka klina	400
Rolka kotwiczna	227
Rolka dziobowa	227
Rolka liny	196
Rolka liny, Sprenger	336
Rolka przyczepy	400
Rolka refliny	343
Rolka refliny/blok	343
Rolka taśmy pasa	228
Rolka taśmy pasa kotwicy	228
Rura	168

S

Sanie precyzyjne	341
Sanie precyzyjne, Sprenger	339 - 340
Ściągacz śruba rzymska	105
Skracacz Duplex	230
Słup oświetleniowy	401
Sopa relingu	171 - 172, 178, 186
Sprzączka pasa	199, 200
Śruba oczkowa	347 - 348, 352 - 353
Śruba oczkowa z gwintem do drewna	117
Śruba rzymska	106
Śruba rzymska Duplex	105
Śruba rzymska, nakrętka Duplex	109
Śruba z uchem	354
Śruba z uchem, Duplex	230
Śruby hakowe	106 - 107
Śruby oczkowe	108
Śruby pałaka	353
Stoper drzwi	387
Stoper łańcucha	224 - 225
Stoper zaciskowy	137 - 139
Stoper zaciskowy liny stalowej	137 - 139



S	Strona	U	Strona
Stopka anteny	383 - 384	Uchwyt pasa	195
Stopka relingu	169 - 171, 173	Uchwyt płyty stołu	386
Stopka relingu do spawania	174 - 176, 361, 364	Uchwyt poręczy	181
Stopnie masztu	384	Uchwyt rur	172
Sworzeń	142, 144- 145, 147	Uchwyt rury	172
Sworzeń oczkowy	345 - 347, 349 - 351	Uchwyt skrzyni	299
Sworzeń oczkowy z gwintem do drewna	351	Uchwyt spinakera	365
Sworzeń z zabezpieczeniem kulowym	145	Uchwyt sprężynowy luki	386
Szczypce dociskowe hydrauliczne	148	Uchwyty kierujące	197
Szekla	84 - 92		
Szekla aluminiowa	86	W	
Szekla szotowa	74, 103	Wciągarka	403
Szekla z zabezpieczeniem	96	Wentylator	373 - 374
Szekla zatrzaskowa	92 - 93	Wentylator pokładowy	373
Szekla zatrzaskowa szotowa	93	Wiadro	358
Szekla, Duplex	229	Wciągarkę	403
Szlifierka	421	Widelec dla mocowania liny cumowniczej	194
Szpic harpuna	392	Wieszak	288 - 291
Szybkozłącze łańcucha	74, 103	Wieszak na liny	295
Szybkozłącze rury	169	Wkręt hakowy	348, 352
Szyna precyzyjna, Sprenger	338	Wlew paliwa	378
		Wlew paliwa diesel	377 - 378
T		Wlot wody	380, 427
Tarcze z rzepem do polerki	421	Wlot wody, mosiężny	434
Taśma naprawcza	420	Wózek do silników zaburtowych	406
Teownik, składany	176	Wskaźnik kierunku wiatru	358
Terminal do lin skręcany	122 - 123	Wspornik bramy	169
Terminal z gwintem do drewna - prawy	113 - 114	Wspornik relingu	169
Terminal z gwintem wewnętrznym	118 - 119	Wylot wody	379
Tikal TefGel	422	Wylot zatrzasku	275
Togiel, przegub łączenie	122	Wysięgnik kotwicy	228
Torba pałaka	195 - 196	Wysięgnik kotwicy rufy	228
Trzpień z liną bezpieczeństwa	147		
		Z	
U		Zacisk kabłkowy do lin Duplex	136
Ucho cumownicze	343 - 345	Zacisk krzyżowy	137 - 138
Ucho cumownicze z nakrętką zrywalną	344	Zacisk lin stalowych kubełkowy	136 - 137, 142
Ucho pokładowe	362 - 363	Zacisk linowy kabłkowy	135, 142
Ucho pokładowe z kółkiem	204, 206	Zacisk liny tuleja miedziana	141
Ucho składane	202 - 203	Zacisk szant	83
Uchwyt	300 - 302	Zacisk tulejowy	140
Uchwyt antenowy	383, 384	Zacisk tulejowy aluminiowy	141
Uchwyt bosaka	296	Zaciski liny	310
Uchwyt butelki	395 - 396	Zaciski liny, Sprenger	337
Uchwyt drzwi, magnetyczny	388 - 390	Zamek	390
Uchwyt liny gumowej	196	Zamek drzwi, magnetyczny	391
Uchwyt liny ratunkowej	365	Zamek z przyciskiem	392
Uchwyt na drąg flagi	396	Zamknięcie	267 - 270, 280 - 285, 386
Uchwyt na butelkę	367 - 368	Zamknięcie dźwignienki ustalającej	285
Uchwyt na kubek	394 - 396	Zamknięcie dźwigniowe	269 - 274
Uchwyt na wędkę	380 - 383, 396	Zamknięcie klapy, guma	275
Uchwyt odbijacza w formie knagi	309	Zamknięcie oczkowe	209
Uchwyt odbijacza, podwójny	361	Zamknięcie pasa napinającego	201



PL

Z

Strona

Zasuwa drzwi	282, 284, 381
Zasuwa przesuwna	282 - 283
Zasuwka	283
Zatrask drzwi	388
Zatrask kulkowy	388
Zatrask Tenax	152 - 154
Zatrask, zamykany	273
Zawias	233 - 267
Zawias maski silnika	263
Zawias plastikowy	239
Zawias taśmowy	234
Zawias zamykający	281 - 282
Zawias, do przyspawania	266
Zawlecza Beta	146, 494
Zawlecza pierścienia	146, 494
Zawlecza składana	145
Zawlecza składana	145
Zawór kulowy	428, 431
Zestaw drąga flagi	366
Zestaw linowy relingów	131
Zestaw montażowy luki	385
Zewnętrzny uchwyt pokładowy	404 - 405
Zewnętrzny zamek pokładu	405
Złącze 4-drożne	178
Złączka na wąż	431 - 432
Złączka rurowa	428 - 430
Złączka rurowa, mosiężna	432 - 435
Złączka skręcana	500



Für das gesamte Sortiment gilt:

- Empfohlene Verkaufspreise ohne MwSt auf Anfrage
- Alle Maß- und Belastungsangaben sowie Abbildungen sind unverbindlich
- Grundsätzlich sind alle Artikel nicht für das Heben von Lasten bzw. für die persönliche Schutzausrüstung (PSA) vorgesehen
Die Artikel, die für das Heben von Lasten vorgesehen sind, sind speziell gekennzeichnet
- Mögliche technische Änderungen behalten wir uns vor
- Alle Bruchlast- und / oder Arbeitslastangaben sind nur gültig bei korrekter axialer 1-Strang-Aufhängung ohne Aufspreizung



The following applies to the entire range:

- Suggested retail price without tax on demand
- All dimensional and loading information as well as illustrations are non-binding
- As a basic principle, all articles are not intended for lifting loads or for use as personal protective gear
Articles which are intended for lifting loads are specially labelled
- We reserve the right to make possible technical changes
- All breaking load and/or working load specifications are only valid for correct axial single-line suspension without spreading



Les points suivants s'appliquent pour l'ensemble de la gamme:

- Prix de vente recommandés hors taxes sur demande
- Toutes les dimensions et charge admissible ainsi que les illustrations sont non contractuelles
- De manière générale, l'ensemble des articles ne sont pas conçus pour soulever des charges ou pour l'équipement de protection personnel
Les articles conçus pour soulever des charges sont marqués en conséquence
- Sous réserve d'éventuelles modifications techniques
- Toutes les spécifications concernant les charge de rupture et charge maximale d'utilisation sont valides à condition que le levage soit réalisé avec une seul élément, axial et centré



Se aplica a toda la gama:

- Precios de venta recomendados sin IVA a pedido
- Todos los datos de dimensiones y de datos de carga, así como las ilustraciones son sin compromiso
- En principio, los artículos no están previstos para la elevación de cargas ni para los equipos de protección individual
Los artículos previstos para la elevación de cargas están marcados específicamente
- Nos reservamos el derecho de realizar posibles cambios técnicos
- Todas las indicaciones sobre carga de rotura y carga de trabajo sólo serán válidas con una suspensión axial correcta de 1 cuerda



Obowiązuje cały asortyment:

- Sugerowane ceny sprzedaży bez VAT na życzenie
- Wszystkie dane wymiarowe dane obciążenia, a także rysunki nie są wiążące
- Zasadniczo wszystkie artykuły nie są przeznaczone do podnoszenia ciężarów lub do indywidualnego wyposażenia ochronnego!
Artykuły przeznaczone do podnoszenia ciężarów lub są specjalnie oznaczone
- Zastrzegamy sobie prawo do wprowadzania zmian technicznych
- Wszystkie informacje dotyczące obciążenia zrywającego i obciążenia roboczego są ważne wyłącznie w przypadku prawidłowego zawieszenia osiowego na jednym paśmie bez naprężenia



Zum Heben von Lasten geeignet

Suitable for lifting loads
Convient pour le levage de charges



MT-Serie

MT series
Série MT



Duplex D6 1.4462

Duplex D6 1.4462
Duplex D6 1.4462



Polyamid

Polyamide
Polyamide

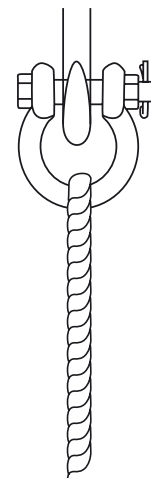

Richtig
Correct

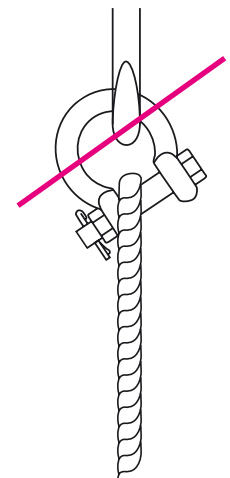

Falsch
Not correct

Kapitel 1	P. 67	8249	P. 68	8250	P. 68	814594	P. 68	8232	P. 69	8949	P. 69
											
8950	P. 69	8293	P. 69	8294	P. 70	8488	P. 70	814841	P. 70	8322	P. 71
											
8951	P. 71	8305	P. 71	815157	P. 71	8953	P. 72	8954	P. 72	8489	P. 72
											
8955	P. 72	8957	P. 73	8956	P. 73	8962	P. 73	8959	P. 73	8960	P. 74
											
8253	P. 74	8838	P. 74	814654	P. 74	8958	P. 75	8961	P. 75	8948	P. 75
											
8338	P. 75	8679	P. 76	814387	P. 76	8251	P. 76	814959	P. 76	814958	P. 77
											
815155	P. 77	815156	P. 77	814844	P. 78	8533	P. 78	814670	P. 78	814672	P. 78
											
814671	P. 79	814669	P. 79	814674	P. 79	814673	P. 79	8493	P. 80	8490	P. 80
											

814960	P. 80	8494	P. 81	8287	P. 81	8971	P. 81	8303	P. 81	814977	P. 82
											
8257	P. 82	8534	P. 82	815071	P. 82	814971	P. 83	8416	P. 83	814656	P. 83
				 NEW							
8491	P. 83	8258	P. 84	815141	P. 84	8326	P. 84	8482	P. 85	814839	P. 85
				 NEW							
814069	P. 85	815102	P. 85	814737	P. 86	8259	P. 86	815145	P. 86	8331	P. 87
		 NEW						 NEW			
8297	P. 87	8298	P. 87	8337	P. 87	8969	P. 88	8260	P. 88	815142	P. 88
										 NEW	
8222	P. 89	8970	P. 89	814068	P. 89	8296	P. 90	815146	P. 90	814946	P. 90
								 NEW			
8299	P. 90	8306	P. 91	8977	P. 91	8324	P. 91	8323	P. 91	815154	P. 92
										 NEW	
8288	P. 92	8252	P. 92	8262	P. 93	8289	P. 93	8290	P. 93	8485	P. 93
											

8254 P. 94	8255 P. 94	815147 P. 94  NEW	814105 P. 95	8256 P. 95	815148 P. 95  NEW
8535 P. 96	814840 P. 96	8364 P. 96	815143 P. 96  NEW	Kapitel 2 P. 97 	8245 P. 98
815037 P. 98	8275 P. 99	8276 P. 99	815163 P. 100  NEW	814065 P. 100	814066 P. 100
815103 P. 101 NEW	8386 P. 101	8432 P. 101	814552 P. 102  NEW	814551 P. 102  NEW	815220 P. 102  NEW
814553 P. 103  NEW	8452 P. 103	8453 P. 103	8455 P. 103	8456 P. 104	8418 P. 104
8457 P. 104	8468 P. 104	8246 P. 105	815060 P. 105  NEW	814932 P. 106	8339 P. 106
8435 P. 106	8436 P. 107	815105 P. 107  NEW	815106 P. 107  NEW	8433 P. 108	8434 P. 108
815107 P. 108  NEW	815108 P. 109  NEW	815109 P. 109  NEW	8417 P. 109	8307 P. 110	8467 P. 110

8445	P. 111	8446	P. 111	814866	P. 111	814867	P. 111	8449	P. 112	8450	P. 112
											
815121	P. 112	8466	P. 112	8459	P. 113	8448	P. 113	8464	P. 113	814087	P. 113
 NEW 											
814088	P. 114	8484	P. 114	8511	P. 114	8515	P. 115	8516	P. 115	8469	P. 115
											
8281	P. 116	814863	P. 116	814864	P. 116	8454	P. 117	8458	P. 117	815015	P. 117
										 	
8282	P. 118	8302	P. 118	815100	P. 118	815101	P. 119	8280	P. 119	8447	P. 119
				 NEW 		 NEW 					
814067	P. 120	8483	P. 120	815016	P. 120	8486	P. 121	8503	P. 121	815017	P. 121
				 						 	
8278	P. 122	8403	P. 122	8404	P. 122	8406	P. 123	8451	P. 123	814868	P. 123
											
8346	P. 124	8350	P. 124	8283	P. 124	814077	P. 124	814167	P. 125	8382	P. 125
											
											7x19

<p>815056 P. 126</p> <p>NEW</p>  <p>7x19</p>	<p>815082 P. 126</p> <p>NEW</p>  <p>6x36</p>	<p>815055 P. 126</p> <p>NEW</p>  <p>7x7</p>	<p>8379 P. 127</p>  <p>7x7</p>	<p>815161 P. 127</p> <p>NEW</p>  <p>8x7</p>	<p>814593 P. 128</p> <p>Transparent / Transparency</p>  <p>7x7 + PVC</p>
<p>8381 P. 128</p> <p>Weiß / White</p>  <p>7x7 + PVC</p>	<p>815104 P. 128</p> <p>Transparent / Transparency</p> <p>NEW</p>  <p>7x19 + PVC</p>	<p>816012 P. 128</p> <p>NEW</p>  <p>7x7 + PVC</p>	<p>8378 P. 129</p>  <p>1x19</p>	<p>814931 P. 129</p>  <p>1x19 / Made in Korea</p>	<p>814979 P. 130</p> 
<p>8475 P. 131</p> 	<p>8247 P. 132</p> 	<p>8536 P. 132</p> 	<p>815058 P. 133</p> <p>NEW</p> 	<p>8636 P. 133</p> 	<p>815061 P. 133</p> <p>NEW</p> 
<p>814453 P. 134</p> 	<p>814984 P. 135</p> 	<p>8248 P. 135</p> 	<p>815059 P. 136</p> <p>NEW</p> 	<p>814391 P. 136</p> 	<p>8304 P. 136</p> 
<p>8284 P. 137</p> 	<p>814722 P. 137</p> 	<p>8424 P. 137</p> 	<p>814817 P. 137</p> 	<p>815068 P. 138</p> <p>NEW</p> 	<p>815069 P. 138</p> <p>NEW</p> 
<p>815091 P. 138</p> <p>NEW</p> 	<p>815092 P. 139</p> <p>NEW</p> 	<p>814700 P. 139</p> 	<p>814701 P. 139</p> 	<p>8470 P. 140</p> 	<p>8285 P. 140</p> 
<p>8285 P. 141</p> 	<p>8471 P. 141</p> 	<p>815001 P. 142</p> 	<p>815002 P. 142</p> 	<p>8279 P. 142-143</p> 	<p>8356 P. 144</p> 
<p>815014 P. 144</p> 	<p>8474 P. 145</p> 	<p>814729 P. 145</p> 	<p>814076 P. 145</p> 	<p>8273 P. 145</p> 	<p>8431 P. 146</p> 

814911 P. 146	8383 P. 146	8358 P. 146	8719 P. 147	8590 P. 147	814996 P. 147
8504 P. 147	814678 P. 148	814679 P. 148	814810 P. 148	8462 P. 149	8499 P. 149
Kapitel 3 P. 151	815095 P. 152	816000 P. 152	815096 P. 152	815098 P. 153	815099 P. 153
3	TENAX® NEW 	TENAX® NEW 	TENAX® NEW 	TENAX® NEW 	TENAX® NEW
816002 P. 153	816001 P. 154	815097 P. 154	816003 P. 154	8667 P. 154	8696 P. 155
TENAX® NEW 	TENAX® NEW 	TENAX® NEW 	TENAX® NEW 		
814411 P. 155	816013 P. 155	814412 P. 155	814413 P. 156	814414 P. 156	814415 P. 156
	NEW 				
814035 P. 157	814036 P. 157	814037 P. 157	814038 P. 157	814760 P. 158	814761 P. 158
DOT 	DOT 	DOT 	DOT 	DOT 	DOT
824762 P. 158	814763 P. 158	814040 P. 159	814041 P. 159	814039 P. 159	814228 P. 159
DOT 	DOT 	DOT 	DOT 	DOT 	DOT
814229 P. 160	814230 P. 160	814231 P. 160	814232 P. 160	814233 P. 161	814234 P. 161
DOT 	DOT 	DOT 	DOT 	DOT 	DOT

814249 P. 161 	814237 P. 161 	814238 P. 162 	814239 P. 162 	814240 P. 162 	814241 P. 162 
814242 P. 163 	814243 P. 163 	814244 P. 163 	814245 P. 163 	814246 P. 164 	814247 P. 164 
814248 P. 164 	814951 P. 164 	814742 P. 165 	814743 P. 165 	Kapitel 4 P. 167 	8292 P. 168 
8532 P. 168 	814642 P. 168 	8531 P. 169 	8546 P. 169 	814316 P. 169 	814304 P. 169 
814305 P. 170 	814306 P. 170 	814307 P. 170 	8201 P. 170 	8202 P. 171 	8203 P. 171 
8204 P. 171 	8325 P. 171 	814909 P. 172 	814607 P. 172 	8360 P. 172 	8632 P. 173 
8633 P. 173 	8534 P. 173 	8635 P. 173 	8907 P. 174 	8908 P. 174 	8909 P. 174 
8612 P. 174 	8613 P. 175 	8614 P. 175 	8615 P. 175 	8616 P. 175 	8617 P. 176 































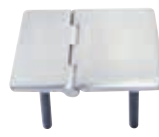























8205	P. 176	8822	P. 176	814699	P. 176	8206	P. 177	8210	P. 177	8211	P. 177
											
815158	P. 177	8387	P. 178	8565	P. 178	8562	P. 178	8208	P. 178	8207	P. 179
	NEW										
814410	P. 179	8209	P. 179	8213	P. 179	815029	P. 180	8702	P. 180	8703	P. 180
											
814962	P. 180	824961	P. 181	8214	P. 181	8212	P. 181	814684	P. 181	814685	P. 182
											
814589	P. 182	814637	P. 183	814638	P. 183	8310	P. 184	8662	P. 184	814781	P. 184
											
814782	P. 184	814783	P. 185	814997	P. 185	814998	P. 185	8216	P. 185	8327	P. 186
											
8309	P. 186	8663	P. 186	814995	P. 186	8658	P. 187	8665	P. 187	8478	P. 187
											
814048	P. 187	8311	P. 188	8313	P. 188	8328	P. 188	8856	P. 188	8329	P. 189
											

8312 P. 189	8853 P. 189	814166 P. 189	8611 P. 190	8652 P. 190	8819 P. 190
					
8820 P. 190	814116 P. 191	814808 P. 191	814985 P. 191	814986 P. 191	814987 P. 192
					
814988 P. 192	814989 P. 192	814990 P. 192	814991 P. 193	815150 P. 193	815151 P. 193
					
814992 P. 193	814993 P. 194	814730 P. 194	8542 P. 194	814207 P. 194	8366 P. 195
					
814950 P. 195	8698 P. 195	8699 P. 195	8697 P. 196	814210 P. 196	8226 P. 196
					
8227 P. 197	8855 P. 197	814658 P. 197	8860 P. 197	815005 P. 198	8540 P. 198
					
8541 P. 198	814655 P. 198	814902 P. 199	8496 P. 199	814955 P. 199	8543 P. 199
					
814969 P. 200	814970 P. 200	814910 P. 200	8764 P. 200	8829 P. 201	8823 P. 201
					

814106  	P. 201	8824 	P. 202	8814 	P. 202	8579 	P. 202	815045 	P. 202 NEW	815160 	P. 203 NEW
815046 	P. 203 NEW	814662 	P. 203	8266 	P. 204	814784 	P. 204	8224 	P. 204	8225 	P. 204
814788 	P. 205	8396 	P. 205	8397 	P. 205	8365 	P. 205	8264 	P. 206	8265 	P. 206
8223 	P. 206	815131 	P. 206 NEW	815053 	P. 207 NEW	815054 	P. 207 NEW	815063 	P. 207 NEW	815052 	P. 207 NEW
8353 	P. 208	8368 	P. 208	814785 	P. 208	8972 	P. 208	814657 	P. 209	814117 	P. 209
814118 	P. 209	8263 	P. 210	814100 	P. 210	814601 	P. 210	814115 	P. 211	8439 	P. 211
8440 	P. 211	Kapitel 5 	P. 213	Röttgers 	P. 214 - P. 216	8240 	P. 217	8315 	P. 217	8300 	P. 218
815187 	P. 218 NEW	8301 	P. 219	8747 	P. 219	8695 	P. 220	814972 	P. 220	814973 	P. 221

814780	P. 221	8821	P. 221	8286	P. 222	8363	P. 222	8414	P. 222	8376	P. 223
8530	P. 223	8547	P. 223	814905	P. 223	814843	P. 224	8460	P. 224	8308	P. 224
814302	P. 224	8506	P. 225	815196	P. 225	815197	P. 225	8352	P. 225	8359	P. 226
8608	P. 226	815140	P. 226	814652	P. 226	814663	P. 227	8388	P. 227	8560	P. 227
8595	P. 227	8566	P. 228	814386	P. 228	8551	P. 228	815111	P. 229	815112	P. 229
815113	P. 229	815114	P. 230	815115	P. 230	815116	P. 230	815117	P. 231	815118	P. 231
815119	P. 231	Kapitel 6	P. 233	8321	P. 234	8233	P. 234	814940	P. 234	814920	P. 235
		6									
8234	P. 235	8237	P. 235	8231	P. 235	8235	P. 236	8236	P. 236	814926	P. 236

8858	P. 236	814163	P. 237	814164	P. 237	814162	P. 237	814165	P. 237	8514	P. 238
											
8513	P. 238	814045	P. 238	814159	P. 238	815184	P. 239	815079	P. 239	815080	P. 239
							NEW		NEW		NEW
815081	P. 239	8952	P. 240	816005	P. 240	814160	P. 240	814161	P. 240	8569	P. 241
	NEW				NEW						
8568	P. 241	815180	P. 241	815181	P. 241	815185	P. 241	8577	P. 242	8578	P. 242
			NEW		NEW		NEW				
8906	P. 242	8576	P. 242	815039	P. 243	815040	P. 243	8570	P. 243	8430	P. 243
											
815182	P. 244	8429	P. 244	8572	P. 244	815183	P. 244	8904	P. 245	8571	P. 245
	NEW						NEW				
8900	P. 245	8981	P. 245	8982	P. 246	8575	P. 246	8574	P. 246	8573	P. 246
											
814941	P. 247	815178	P. 247	8902	P. 247	8903	P. 247	814881	P. 248	815083	P. 248
			NEW						NEW		NEW

8567 P. 248  	814796 P. 248 	814797 P. 249 	814798 P. 249 	814799 P. 249 	814800 P. 249 
814801 P. 250 	814802 P. 250 	815164 P. 250 NEW 	815165 P. 250 NEW 	814908 P. 251 	815041 P. 251 
814937 P. 251 	814938 P. 251 	815042 P. 252 NEW 	815127 P. 252 NEW 	8924 P. 252 	8925 P. 252 
8926 P. 253 	8927 P. 253 	8928 P. 253 	8929 P. 253 	8920 P. 254 	8921 P. 254 
8918 P. 254 	8919 P. 254 	8922 P. 255 	8923 P. 255 	8932 P. 255 	8933 P. 255 
8910 P. 256 	8911 P. 256 	8912 P. 256 	8913 P. 256 	8914 P. 257 	8915 P. 257 
8930 P. 257 	8931 P. 257 	814125 P. 258 	8917 P. 258 	8674 P. 258  	8675 P. 258  
8676 P. 259  	814738 P. 259  	8677 P. 259  	8678 P. 259  	814820 P. 260  	814822 P. 260  

814821 P. 260  	814824 P. 261  	814823 P. 261  	814903 P. 261  	814825 P. 262  	814826 P. 262  
814827 P. 262  	814923 P. 262  	814924 P. 263  	814033 P. 263 	8239 P. 263 	8512 P. 263 
814158 P. 264 	8671 P. 264 	8670 P. 264 	8897 P. 264 	815179 P. 265 NEW 	8905 P. 265 
8238 P. 265 	814752 P. 265 	814750 P. 266 	814751 P. 266 	814754 P. 266 	814753 P. 266 
815013 P. 267 	8859 P. 267 	8428 P. 267  	815171 P. 267 NEW 	815172 P. 268 NEW 	8588 P. 268 
8518 P. 268 	8717 P. 268 	8519 P. 269 	8854 P. 269 	815173 P. 269 NEW 	8427 P. 269 
815174 P. 270 NEW 	814666 P. 270  	815191 P. 270  NEW 	814667 P. 270  	814912 P. 271  	8862 P. 271 
814789 P. 271 	814790 P. 271 	81479 P. 272 	814792 P. 272 	814793 P. 272 	814794 P. 272 

814795 P. 273	814813 P. 273	815169 P. 273 NEW	815170 P. 273 NEW	815166 P. 274 NEW	815167 P. 274 NEW
815168 P. 274 NEW	814956 P. 274	814954 P. 275	8834 P. 275	814060 P. 275	8648 P. 275
814726 P. 276	8816 P. 276	815190 P. 276 NEW	814731 P. 277	814739 P. 277	814740 P. 277
8589 P. 278	8241 P. 278	814787 P. 278	8242 P. 278	815186 P. 279 NEW	815003 P. 279
8243 P. 279	814963 P. 279	814953 P. 280	8527 P. 280	815049 P. 280 NEW	8892 P. 281
815009 P. 281	815070 P. 281 NEW	814064 P. 282	814691 P. 282	8413 P. 282	815038 P. 283
816006 P. 283 NEW	814917 P. 283	815006 P. 284	815007 P. 284	814744 P. 284	815047 P. 285 NEW
814650 P. 285	815198 P. 285 NEW	8318 P. 286	8650 P. 286	8384 P. 286	814922 P. 286

814901 P. 287	8348 P. 287	8347 P. 287	8361 P. 287	8399 P. 288	8400 P. 288
8401 P. 288	814081 P. 288	814659 P. 289	814660 P. 289	814665 P. 289	814082 P. 289
814083 P. 290	814664 P. 290	8476 P. 290	814942 P. 290	8830 P. 291	816017 P. 291
					NEW
814079 P. 291	814080 P. 291	814070 P. 292	8398 P. 292	8966 P. 292	8968 P. 293
825090 P. 293	8340 P. 293	815138 P. 293	8341 P. 294	814085 P. 294	815137 P. 294
NEW		NEW			NEW
815136 P. 294	815135 P. 295	814966 P. 295	814943 P. 295	814944 P. 295	8584 P. 296
NEW	NEW				
8593 P. 296	8229 P. 296	8274 P. 297	815012 P. 297	815152 P. 297	8349 P. 298
				NEW	
8963 P. 298	8975 P. 298	8965 P. 298	8964 P. 299	8501 P. 299	8270 P. 299

8857	P. 299	8335	P. 300	8336	P. 300	814078	P. 300	814724	P. 300	814725	P. 301
											
814680	P. 301	815050	P. 301	814721	P. 301	8507	P. 302	8442	P. 302	814189	P. 302
		 NEW									
814190	P. 302	Kapitel 7	P. 303	8217	P. 304	8218	P. 304	8221	P. 304	814925	P. 304
											
8680	P. 305	815110	P. 305	814554	P. 305	814858	P. 306	814859	P. 306	8529	P. 306
		 NEW		 NEW							
814303	P. 306	8827	P. 307	814640	P. 307	814641	P. 307	8508	P. 308	8557	P. 308
											
8885	P. 308	8886	P. 308	815088	P. 309	8517	P. 309	814939	P. 309	8367	P. 309
				 NEW							
8973	P. 310	814137	P. 310	8219	P. 310	8220	P. 310	8865	P. 310	8840	P. 311
											
8391	P. 311	8407	P. 311	814886	P. 311	Sprenger	P. 312 - P. 315	8146082-01	P. 316	8146082-02	P. 316
											

8146082-03 P. 316 	8146082-04 P. 316 	8146082-05 P. 316 	8146082-06 P. 316 	8146082-07 P. 316 	8146082-08 P. 316 
8146092-01 P. 318 	8146092-02 P. 318 	8146092-03 P. 318 	8146092-04 P. 318 	8146092-05 P. 318 	8146092-06 P. 318 
8146092-07 P. 318 	8146092-08 P. 318 	8146092-09 P. 318 	8146092-11 P. 318 	8146092-12 P. 318 	8146092-13 P. 318 
8146102-01 P. 320 	8146102-02 P. 320 	8146102-03 P. 320 	8146102-04 P. 320 	8146102-05 P. 320 	8146102-06 P. 320 
8146102-07 P. 320 	8146102-08 P. 320 	8146102-09 P. 320 	8146102-10 P. 320 	8146102-11 P. 320 	8146102-12 P. 320 
8146102-13 P. 320 	8146102-14 P. 320 	8146133-01 P. 322 	8146133-02 P. 322 	8146133-04 P. 322 	8146133-05 P. 322 
8146133-06 P. 322 	8146133-07 P. 322 	8146133-08 P. 322 	8146133-09 P. 322 	8146133-10 P. 322 	8146133-11 P. 322 
8146133-12 P. 322 	8146133-13 P. 322 	8146133-16 P. 322 	8146133-17 P. 322 	8148933-01 P. 324 	8148933-02 P. 324 

8148933-03 P. 324 	8148933-04 P. 324 	8148933-05 P. 324 	8146112-01 P. 325 	8146112-02 P. 325 	8146112-03 P. 325 
8146112-04 P. 325 	8146143-01 P. 326 	8146143-02 P. 326 	8146143-03 P. 326 	8146143-04 P. 326 	8146143-05 P. 326 
8146143-06 P. 326 	8146143-07 P. 326 	8146143-09 P. 326 	8146143-11 P. 326 	8146143-12 P. 326 	8146143-13 P. 326 
8146143-15 P. 326 	8146143-16 P. 326 	8146122-01 P. 328 	8146122-02 P. 328 	8146122-03 P. 328 	8148943-01 P. 329 
8148943-02 P. 329 	8148943-03 P. 329 	8148943-04 P. 329 	8148943-05 P. 329 	8146153-01 P. 330 	8146153-02 P. 330 
8146153-03 P. 330 	8146153-04 P. 330 	8146153-05 P. 330 	8146153-06 P. 330 	8146153-08 P. 330 	8146153-09 P. 330 
8146153-11 P. 330 	8146153-12 P. 330 	8146153-13 P. 330 	8146153-14 P. 330 	8148953-01 P. 332 	8148953-02 P. 332 
8148953-03 P. 332 	8148953-04 P. 332 	8148953-05 P. 332 	8148953-06 P. 332 	8148953-07 P. 332 	814896 P. 333 

814616 P. 333 	814889 P. 333 	814888 P. 333 	814617 P. 334 	814618 P. 334 	814887 P. 334 
815035 P. 334 	815036 P. 335 	814891 P. 335 	814890 P. 335 	814885 P. 335 	814619 P. 336 
814620 P. 336 	814621 P. 336 	814623 P. 336 	814633 P. 337 	814634 P. 337 	814635 P. 337 
814716 P. 337 	814636 P. 338 	8344 P. 338 	814624 P. 338 	814625 P. 338 	814626 P. 339 
814627 P. 339 	814628 P. 339 	814629 P. 339 	814630 P. 340 	814631 P. 340 	814632 P. 340 
8872 P. 341 	8369 P. 341 	8393 P. 341 	814981 P. 341 	814982 P. 342 	814983 P. 342 
8390 P. 342 	8392 P. 342 	8402 P. 343 	8395 P. 343 	8526 P. 343 	8230 P. 343 
8651 P. 344 	815174 P. 344  NEW	814223 P. 344 	814906 P. 344 	8979 P. 345 	814112 P. 345 
					

8267	P. 345	815211	P. 345	815020	P. 346	815066	P. 346	815064	P. 346	815018	P. 347
		 NEW				 NEW		 NEW			
8473	P. 347	815210	P. 348	816014	P. 348	816015	P. 348	814871	P. 348	814089	P. 349
		 NEW		 NEW		 NEW					
814967	P. 349	814968	P. 349	815067	P. 350	8271	P. 350	815065	P. 350	815019	P. 351
				 NEW				 NEW			
8974	P. 351	814086	P. 351	8316	P. 352	8317	P. 352	814869	P. 352	814870	P. 352
											
8976	P. 353	814110	P. 353	814111	P. 353	8268	P. 353	8261	P. 354	815189	P. 354
										 NEW	
8272	P. 354	8269	P. 355	8537	P. 355	8538	P. 355	Kapitel 8	P. 357	8524	P. 358
											
8528	P. 358	8942	P. 358	8887	P. 359	8867	P. 359	8868	P. 359	8437	P. 360
											
814044	P. 360	8618	P. 361	8607	P. 361	8641	P. 361	814661	P. 362	8291	P. 362
											

814900 P. 362	8539 P. 362	814913 P. 363	814916 P. 363	814921 P. 364	814119 P. 364
814132 P. 364	8461 P. 365	8422 P. 365	8444 P. 365	8438 P. 366	814133 P. 366
814717 P. 366	8653 P. 366	8654 P. 367	8587 P. 367	8586 P. 367	815086 P. 367
814114 P. 368	8599 P. 368	814217 P. 368	8556 P. 368	814653 P. 369	814681 P. 369
8370 P. 369	8371 P. 369	815176 P. 370	8372 P. 370	815177 P. 370	8373 P. 370
814964 P. 371	8374 P. 371	814965 P. 371	815133 P. 371	8375 P. 372	814225 P. 372
814927 P. 372	814073 P. 372	814074 P. 373	8342 P. 373	8713 P. 373	8657 P. 373
8701 P. 374	814918 P. 374	8345 P. 374	814933 P. 374	8894 P. 375	8895 P. 375

8861 P. 375	8319 P. 375	8320 P. 376	815123 P. 376 NEW	814719 P. 376	814720 P. 376
815194 P. 377 NEW	814929 P. 377	8314 P. 377	814930 P. 378	814058 P. 378	815153 P. 378 NEW
8835 P. 378	815162 P. 379 NEW	814061 P. 379	814914 P. 379	814107 P. 379	814108 P. 380
815192 P. 380 NEW	814121 P. 380	8421 P. 380	814860 P. 381	814861 P. 381	8550 P. 381
8718 P. 381	814957 P. 382	815062 P. 382 NEW	815076 P. 382 NEW	814054 P. 383	8330 P. 383
8603 P. 383	8604 P. 383	8720 P. 384	8332 P. 384	814113 P. 384	8244 P. 384
814109 P. 385	814149 P. 385	8351 P. 385	8472 P. 386	815195 P. 386 NEW	8610 P. 386
8522 P. 386	8477 P. 387	814099 P. 387	8520 P. 387	8592 P. 388	8521 P. 388

8825 P. 388 	814599 P. 388 	814915 P. 389 	8826 P. 389 	814598 P. 389 	814206 P. 389 
814682 P. 390 	8591 P. 390 	814093 P. 390 	8498 P. 390 	8500 P. 391 	815008 P. 391 
8828 P. 391 	814187 P. 392 	814741 P. 392 	8479 P. 392 	8480 P. 392 	814155 P. 393 NEW 
814156 P. 393 	8377 P. 393 	814862 P. 394 	8441 P. 394 	814136 P. 394 	815085 P. 395 NEW 
814135 P. 395 	8832 P. 395 	8525 P. 395 	8355 P. 396 	815084 P. 396 NEW 	814842 P. 396 
8937 P. 396 	8938 P. 397 	814759 P. 397 	8941 P. 397 	814280 P. 397 	814281 P. 398 
814947 P. 398 	8523 P. 398 	8708 P. 338 	8700 P. 399 	8596 P. 399 	8669 P. 399 
814120 P. 399 	8880 P. 400 	8881 P. 400 	8882 P. 400 	8883 P. 400 	8884 P. 401 

814092	P. 401	8998	P. 401	814126	P. 401	814127	P. 402	814688	P. 402	814151	P. 402
814152	P. 402	814692	P. 403	814098	P. 403	814129	P. 403	8559	P. 403	8891	P. 404
816016	P. 404	8706	P. 404	8934	P. 404	814596	P. 405	814590	P. 405	8554	P. 405
NEW											
814282	P. 405	816004	P. 406	814289	P. 406	814290	P. 406	814647	P. 407	814265	P. 407
		NEW									
Marinetown	P. 408 - P. 409	815072	P. 410	815073	P. 411	815074	P. 411	815075	P. 412	815077	P. 412
		NEW		NEW		NEW		NEW		NEW	
8509	P. 412	8510	P. 413	8726	P. 413	814059	P. 413	814712	P. 413	814723	P. 414
814713	P. 414	814714	P. 414	814715	P. 414	Kapitel 9	P. 415	814733	P. 416	814734	P. 416
814999	P. 417	815000	P. 417	815213	P. 417	815122	P. 418	815149	P. 418	815087	P. 418
				NEW		NEW		NEW		NEW	

814974 P. 419	814880 P. 420	814884 P. 420	814831 P. 421	814832 P. 421	814850 P. 422
					
814851 P. 422	814853 P. 422	814855 P. 422	8637 P. 423	814153 P. 423	814948 P. 423
					
814226 P. 423	814803 P. 424	814804 P. 424	8277 P. 424	8415 P. 424	814816 P. 424
					
Kapitel 10 P. 425	8748 P. 426	814757 P. 426	8605 P. 426	8620 P. 426	814936 P. 427
					
8639 P. 427	8749 P. 427	8893 P. 427	8621 P. 428	815021 P. 428	815022 P. 428
					
8638 P. 428	8606 P. 429	8623 P. 429	8625 P. 429	8624 P. 429	8622 P. 430
					
8640 P. 430	8627 P. 430	8626 P. 430	8659 P. 431	815023 P. 431	815024 P. 431
					
815025 P. 431	815026 P. 432	815027 P. 432	814563 P. 432	814564 P. 433	814565 P. 433
					

814566	P. 433	814567	P. 433	814568	P. 434	814569	P. 434	814572	P. 434	814577	P. 434
											
814573	P. 435	814574	P. 435	814576	P. 435	8354	P. 436	8357	P. 436	3016	P. 437
											
1029	P. 438	Kapitel 11	P. 439	Fasterner Finder	P. 440	Blister	P. 442	Blisterwand	P. 443		P. 444
		11								A2 Schrauben in SB-Verpackungen Screws in self- service packages	
	P. 468	Kapitel 12	P. 497	ISO 16584	P. 498	Art.-Nr. 0057	P. 498	ISO 14585	P. 499	ISO 14586	P. 499
A4 Schrauben in SB-Verpackungen Screws in self- service packages		12									
9260	P. 499	815028	P. 500	814856	P. 500	814857	P. 501		P. 502		
								A2 / A4 Schrauben in Großpackungen Screws in bulk packs 			



Schäkel, Karabinerhaken und Wirbel

Shackles, spring hooks and swivels

Manilles, mousquetons et émerillons

Kapitel 1

Chapter 1



Karabinerhaken

Spring hooks
Mousquetons



Schäkel, Schnappschäkel

Shackles, snap shackles
Manilles, Mousquetons de drisse



Wirbel, Wirbelschäkel

Swivels, swivel shackles
Émerillons

1

Schäkel, Karabinerhaken und Wirbel

Shackles, spring hooks and swivels

Manilles, mousquetons et émerillons

8249

Karabinerhaken / A4-AISI 316

Spring hook / Mousqueton pompier

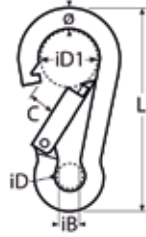

Artikel-Nr. Item-no.	ø	L	iD	iD1	C	iB	**BL kg	Box	*€/Stück *€/piece
8249403 30	3	30	5	8	5	4	140	20	1,90
8249404 40	4	40	9	12	7	5	260	20	1,20
8249405 50	5	50	10	15	8	6	390	20	1,80
8249406 60	6	60	11	18	9	8	450	20	2,00
8249407 70	7	70	13	21	9	8	550	20	2,50
8249408 80	8	80	13	24	9	8	640	20	3,30
8249409 90	9	90	13	27	10	10	730	20	3,80
8249410 100	10	100	16	30	12	10	870	10	5,50
8249411 120	11	120	18	36	16	11	1000	10	6,90
8249412 140	12	140	20	41	19	13	1100	10	10,90
8249413 160	13	160	22	51	25	19	1300	5	13,30
8249414 180	14	180	26	55	30	25	1510	5	24,80

8250

Karabinerhaken mit Kausche / A4-AISI 316

Spring hook with eyelet / Mousqueton pompier à œil

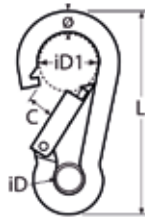

Artikel-Nr. Item-no.	ø	L	iD	iD1	C	iB	**BL kg	Box	*€/Stück *€/piece
8250404 40	4	40	4	12	7	260	20	1,70	
8250405 50	5	50	6	15	8	390	20	2,30	
8250406 60	6	60	7	18	9	450	20	2,50	
8250407 70	7	70	9	21	9	550	20	3,00	
8250408 80	8	80	10	24	9	640	20	4,60	
8250409 90	9	90	10	27	10	730	20	5,50	
8250410 100	10	100	13	30	12	870	10	6,40	
8250411 120	11	120	14	36	16	1000	10	9,60	
8250412 140	12	140	18	41	19	1100	10	12,20	
8250413 160	13	160	20	51	25	1300	5	15,60	

814594

Karabinerhaken mit Sicherheitsmutter / A4-AISI 316

Spring hook with screw sleeve / Mousqueton pompier avec écrou de sécurité

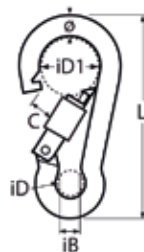

Artikel-Nr. Item-no.	ø	L	iD	iD1	C	iB	**BL kg	Box	*€/Stück *€/piece
814594404 40	4	40	5	12	7	5	200	10	1,90
814594405 50	5	50	9	15	8	6	250	10	2,20
814594406 60	6	60	10	18	9	8	300	10	2,70
814594407 70	7	70	11	21	9	8	400	10	3,40
814594408 80	8	80	13	24	8	8	550	10	4,70
814594409 90	9	90	13	27	10	10	650	10	5,70
814594410 100	10	100	16	30	10	10	750	5	7,00
814594411 120	11	120	18	36	15	11	850	5	10,00
814594412 140	12	140	20	41	19	16	1000	5	12,80
814594413 160	13	160	22	51	25	19	1100	5	17,30

Schäkel, Karabinerhaken und Wirbel

Shackles, spring hooks and swivels

Manilles, mousquetons et émerillons

1

1

Karabinerhaken mit Sicherheitsmutter und Kausche / A4-AISI 316

Spring hook with screw sleeve and eyelet / Mousqueton pompier à œil avec écrou de sécurité

8232

Artikel-Nr. Item-no.	ø	L	iD	iD1	C	**BL kg	Box	*€/Stück *€/piece
8232404 40	4	40	4	12	7	200	10	2,20
8232405 50	5	50	6	15	8	250	10	2,60
8232406 60	6	60	7	18	9	300	10	3,00
8232407 70	7	70	9	21	9	400	10	3,70
8232408 80	8	80	10	24	8	550	10	5,30
8232409 90	9	90	10	27	10	650	10	6,20
8232410 100	10	100	13	30	10	750	5	7,60
8232411 120	11	120	14	36	15	850	5	11,10
8232412 140	12	140	18	41	19	1000	5	16,00
8232413 160	13	160	20	51	25	1100	5	20,00

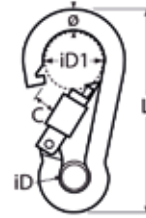

Karabinerhaken mit Springverschluss / A4-AISI 316

Spring hook with self-lock sleeve / Mousqueton pompier ouverture extérieure, fermeture automatique

8949

Artikel-Nr. Item-no.	ø	L	B	iD	iD1	C	iB	**BL kg	Box	*€/Stück *€/piece
8949405 50	5	55	26	8	17	15	6	190	10	3,60
8949406 60	6	60	30	8	19	16	6	210	10	4,50
8949408 80	8	80	40	12	24	23	8	500	10	6,70
8949410 100	10	100	50	15	30	27	10	790	5	10,60

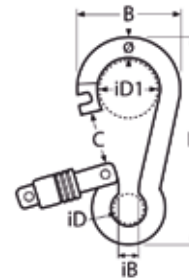

Karabinerhaken mit Springverschluss und Kausche / A4-AISI 316

Spring hook with self-lock sleeve and eyelet / Mousqueton pompier à œil ouverture extérieure, fermeture automatique

8950

Artikel-Nr. Item-no.	ø	L	B	iD	iD1	C	**BL kg	Box	*€/Stück *€/piece
8950405 50	5	55	26	7,8	17	15	190	10	3,80
8950406 60	6	60	30	7,8	19	16	210	10	5,70
8950408 80	8	80	40	10,8	24	23	500	10	7,10
8950410 100	10	100	50	14,0	30	27	790	5	11,10

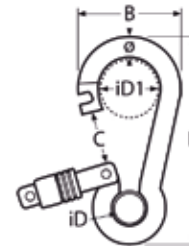

Karabinerhaken mit Spezialverschluss / A4-AISI 316

Spring hook with wide opening / Mousqueton pompier avec grand passage

8293

Artikel-Nr. Item-no.	ø	L	iD	iD1	C	iB	**BL kg	Box	*€/Stück *€/piece
8293408 80	8	80	12	23	15	9	570	10	3,90
8293410 100	10	100	16	30	17	12	830	5	7,10
8293411 120	11	120	19	36	23	15	900	5	10,70

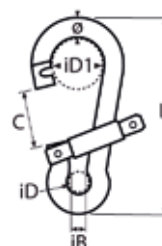

1

Schäkel, Karabinerhaken und Wirbel

Shackles, spring hooks and swivels

Manilles, mousquetons et émerillons

8294

Karabinerhaken mit Spezialverschluss und Kausche / A4-AISI 316

Spring hook with wide opening and eyelet / Mousqueton pompier avec œil aux grand passage

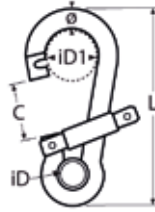

Artikel-Nr. Item-no.	ø	L	iD	iD1	C	**BL kg	Box	*€/Stück *€/piece
8294408 80	8	80	9	23	19	570	10	4,60
8294410 100	10	100	13	30	22	830	5	8,80
8294411 120	11	120	15	36	26	900	5	12,25

8488

Alu-Karabinerhaken / Alu

Alu spring hook / Mousqueton pompier en alu

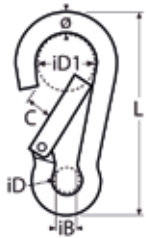

Artikel-Nr. Item-no.	Farbe Colour	ø	L	iD	iD1	C	iB	Box	*€/Stück *€/piece
848805 50	Gemischt / Mixed	5	50	10	15	8	6	10	0,90
848805 50BL	Blau / Blue	5	50	10	15	8	6	10	0,90
848805 50RO	Rot / Red	5	50	10	15	8	6	10	0,90
848805 50SI	Silber / Silver	5	50	10	15	8	6	10	0,90
848805 50GE	Gelb / Yellow	5	50	10	15	8	6	10	0,90
848805 50SC	Schwarz / Black	5	50	10	15	8	6	10	0,90
848806 60	Gemischt / Mixed	6	60	11	16	9	8	10	1,00
848806 60BL	Blau / Blue	6	60	11	16	9	8	10	1,00
848806 60RO	Rot / Red	6	60	11	16	9	8	10	1,00
848806 60SI	Silber / Silver	6	60	11	16	9	8	10	1,00
848806 60GE	Gelb / Yellow	6	60	11	16	9	8	10	1,00
848806 60SC	Schwarz / Black	6	60	11	16	9	8	10	1,00
848808 80	Gemischt / Mixed	8	80	13	25	9	8	10	1,50
848808 80BL	Blau / Blue	8	80	13	25	9	8	10	1,50
848808 80RO	Rot / Red	8	80	13	25	9	8	10	1,50
848808 80SI	Silber / Silver	8	80	13	25	9	8	10	1,50
848808 80GE	Gelb / Yellow	8	80	13	25	9	8	10	1,50
848808 80SC	Schwarz / Black	8	80	13	25	9	8	10	1,50

814841

Karabinerhaken, asymmetrisch / A4-AISI 316

Asymmetric spring hook / Mousqueton pompier asymétrique

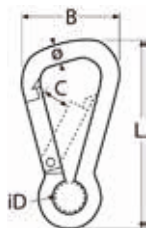

NEW

Artikel-Nr. Item-no.	ø	L	B	iD	C	**BL kg	Box	*€/Stück *€/piece
814841405 50	5	50	26	8	7	280	10	1,80
814841406 60	6	60	35	9	10	300	10	2,00
814841408 80	8	80	47	12	13	550	10	3,70
814841410 100	10	100	60	15	17	750	5	5,80
814841411 120	11	120	70	18	22	850	5	10,60

Schäkel, Karabinerhaken und Wirbel

Shackles, spring hooks and swivels

Manilles, mousquetons et émerillons

1

1

Karabinerhaken, asymmetrisch mit Kausche / A4-AISI 316

Asymmetric spring hook with eyelet / Mousqueton pompier asymétrique à œil

8322

Artikel-Nr. Item-no.	∅	L	B	iD	C	**BL kg	Box	*€/Stück *€/piece
8322405 50	5	50	26	6	7	280	10	2,30
8322406 60	6	60	35	7	10	390	10	2,70
8322408 80	8	80	45	11	13	690	10	5,10
8322410 100	10	100	58	14	18	750	5	7,60
8322411 120	11	120	70	18	24	950	5	11,20

NEW

NEW

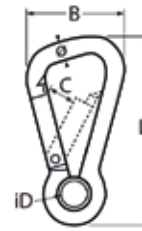

Karabiner, asymmetrisch mit Sicherheitsmutter und Kausche / A4-AISI 316

Asymmetric spring hook with screw sleeve and eyelet / Mousqueton asym. à œil avec écrou de sécurité

8951

Artikel-Nr. Item-no.	∅	L	B	iD	C	**BL kg	Box	*€/Stück *€/piece
8951406 60	6	60	35	8	9	440	10	3,40
8951408 80	8	80	46	11	12	640	10	5,50
8951410 100	10	100	60	14	16	870	5	9,50
8951411 120	11	120	70	18	21	1350	5	13,90



Karabinerhaken mit Bügel / A4-AISI 316

Spring hook with bow / Mousqueton pompier à ressort asymétrique

8305

Artikel-Nr. Item-no.	∅	L	B	iD	C	iB	**BL kg	Box	*€/Stück *€/piece
8305406	6	61	35	7	10	18	440	10	2,60
8305408	8	81	48	11	13	24	1020	10	3,80
8305410	10	102	58	13	15	31	1450	5	7,30
8305412	12	122	70	16	21	41	1880	5	11,00
8305416	16	165	97	25	27	53	2820	5	43,70

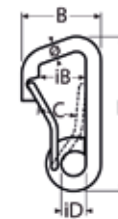

NEW

Karabinerhaken mit Steg / A4-AISI 316

Spring hook with welded bar / Crochet à ressort avec barre soudée

815157

Artikel-Nr. Item-no.	∅	L	C	Box	*€/Stück *€/piece
815157406	6	60	15	10	7,40
815157408	8	80	22	10	8,80
815157410	10	100	25	5	11,50
815157412	12	120	28	5	14,30



1

Schäkel, Karabinerhaken und Wirbel

Shackles, spring hooks and swivels

Manilles, mousquetons et émerillons

8953

Karabinerhaken, asymmetrisch mit Sicherheitsmutter / A4-AISI 316

Asymmetric spring hook with screw sleeve / Mousqueton asymétrique avec écrou de sécurité

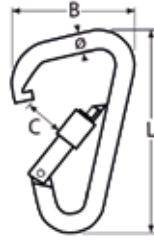

Artikel-Nr. Item-no.	ø	L	B	C	**BL kg	Box	*€/Stück *€/piece
8953411 120	11	120	70	24	1360	5	18,00

8954

Karabinerhaken, asymmetrisch mit Sicherheitsmutter und Steg / A4-AISI 316

Asymmetric spring hook with screw sleeve and bar / Mousqueton asym. avec écrou de sécurité et barette

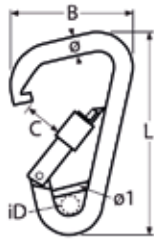

Artikel-Nr. Item-no.	ø	L	B	iD	C	ø1	**BL kg	Box	*€/Stück *€/piece
8954411 120	11	120	70	15	24	3,9	1360	5	23,00

8489

Delta-Schraubverbinder / A4-AISI 316

Delta quick link / Maillon rà visser delta

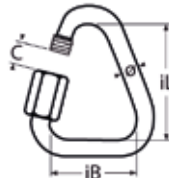

Artikel-Nr. Item-no.	ø	iL	iB	C	Antrieb Drive	**BL kg	Box	*€/Stück *€/piece
8489404	4	31	26	5	SW8	850	10	2,30
8489405	5	38	30	6	SW9	790	10	2,80
8489406	6	44	34	7	SW10	1130	10	3,40
8489408	8	56	39	10	SW13	2000	5	6,00
8489410	10	68	46	12	SW15	3100	5	10,00
NEW 8489412	12	80	50	15	SW18	4500	5	14,50

8955

Karabinerhaken mit Sicherheitsmutter / A4-AISI 316

Spring hook with screw sleeve / Mousqueton avec écrou de sécurité



Artikel-Nr. Item-no.	ø	L	B	C	**BL kg	Box	*€/Stück *€/piece
8955410 115	10	115	60	19	1200	5	12,90

Schäkel, Karabinerhaken und Wirbel

Shackles, spring hooks and swivels

Manilles, mousquetons et émerillons

1

1

Karabinerhaken mit Springverschluss / A4-AISI 316

Spring hook with self-lock sleeve / Mousqueton à fermeture automatique

8957

Artikel-Nr. Item-no.	ø	L	B	C	**BL kg	Box	*€/Stück *€/piece
8957408 64	8	80	45	11	900	10	7,90
8957410 80	10	100	55	14	1180	5	12,70

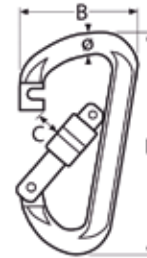

Karabinerhaken mit Springverschluss und Steg / A4-AISI 316

Spring hook with self-lock sleeve and bar / Mousqueton à fermeture automatique avec barette

8956

Artikel-Nr. Item-no.	ø	L	B	iD	C	ø1	**BL kg	Box	*€/Stück *€/piece
8956408 64	8	80	45	13	11	2	900	10	8,40
8956410 80	10	100	55	16	14	2	1180	5	13,70

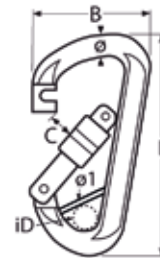

Karabinerhaken, oval / A4-AISI 316

Oval spring hook / Mousqueton oval

8962

Artikel-Nr. Item-no.	ø	L	B	C	**BL kg	Box	*€/Stück *€/piece
8962405 50	5	50	25	8	340	10	2,10
8962406 60	6	60	30	10	490	10	2,30
8962408 80	8	80	40	14	630	10	4,00
8962410 100	10	100	50	16	850	5	7,40

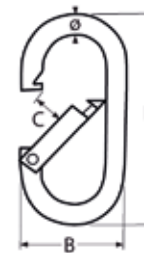

Karabinerhaken, oval mit Sicherheitsmutter / A4-AISI 316

Oval spring hook with screw sleeve / Mousqueton ovale, ouverture ext., écrou de sécurité

8959

Artikel-Nr. Item-no.	ø	L	B	C	**BL kg	Box	*€/Stück *€/piece
8959406 55	6	52	27	14	280	10	4,70
8959408 70	8	70	35	18	490	10	6,40
8959410 90	10	90	45	24	720	5	10,50

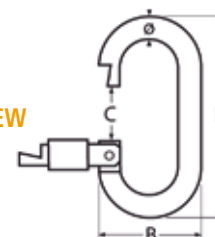

1

Schäkel, Karabinerhaken und Wirbel

Shackles, spring hooks and swivels

Manilles, mousquetons et émerillons

8960

Karabinerhaken, oval mit Springverschluss / A4-AISI 316

Oval spring hook with self-lock sleeve / Mousqueton ovale ouverture ext. fermé automatique

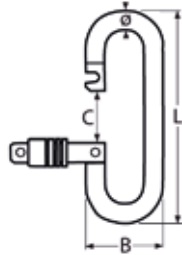

Artikel-Nr. Item-no.	ø	L	B	C	**BL kg	Box	*€/Stück *€/piece
8960405 70	5	70	25	15	210	10	3,80
8960406 80	6	80	30	16	260	10	5,70
8960408 90	8	90	35	23	500	10	6,40
8960410 110	10	110	40	27	1070	5	11,50

8253

Schraubverbinder / A4-AISI 316

Quick link / Maillon à visser



Artikel-Nr. Item-no.	ø	iL	iB	C	Antrieb Drive	**BL kg	Box	*€/Stück *€/piece
8253403	3	25	9,0	4,3	SW6	360	20	1,70
8253404	4	32	12,0	5,5	SW8	500	20	2,10
8253405	5	39	13,0	6,5	SW9	790	20	2,40
8253406	6	45	14,5	7,5	SW10	1130	10	2,50
8253408	8	58	17,5	10,0	SW13	2000	10	4,10
8253410	10	72	21,0	12,0	SW15	3100	5	6,50
8253412	12	81	24,0	14,5	SW18	4500	5	12,40
NEW 8253414	14	97	28,0	17,0	SW22	6720	2	23,10

8838

Schraubverbinder, lang / A4-AISI 316

Long quick link / Maillon à visser long

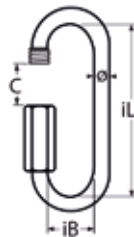

Artikel-Nr. Item-no.	ø	iL	iB	C	Antrieb Drive	**BL kg	Box	*€/Stück *€/piece
8838403	3,5	40	8,5	8,5	SW6	360	20	1,80
8838404	4	45	11,5	11,5	SW8	500	20	2,20
8838405	5	52	13,0	13,0	SW9	1200	20	2,50
8838406	6	60	14,5	15,0	SW10	1400	10	3,40
8838408	8	72	17,0	18,0	SW13	2000	10	5,90
8838410	10	85	20,0	20,0	SW15	3100	5	10,30
8838412	12	100	23,0	23,0	SW18	4500	5	14,50
NEW 8838414	14	114	26,5	27,0	SW22	6720	2	34,10

814654

Schraubverbinder, quadratisch / A4-AISI 316

Square shape quick link / Maillon à visser rectangulaire

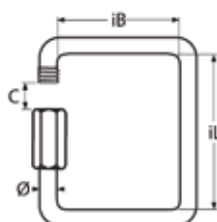

Artikel-Nr. Item-no.	ø	iL	iB	C	**BL kg	Box	*€/Stück *€/piece
814654404	4	31,5	25	5,5	500	10	2,30
814654405	5	37,5	28	6,5	790	10	3,10
814654406	6	43,0	31	7,5	1130	10	4,00
814654408	8	55,0	37	10,0	2000	5	6,40
814654410	10	68,5	43	12,0	3100	5	12,20

Schäkel, Karabinerhaken und Wirbel

Shackles, spring hooks and swivels

Manilles, mousquetons et émerillons

1

1

Karabinerhaken, Birnenform mit Sicherheitsmutter / A4-AISI 316

Spring hook with screw sleeve, pear shaped / Mousqueton avec vis de sécurité, forme poire

8958

Artikel-Nr. Item-no.	ø	L	B	iD	iD1	C	**BL kg	Box	*€/Stück *€/piece
8958406 60	6	60	30	8	17	8	310	10	3,40
8958408 80	8	80	40	10	23	10	540	10	5,40
8958410 100	10	100	50	15	29	12	830	5	10,30
8958411 120	11	120	60	16	35	17	1000	5	11,10

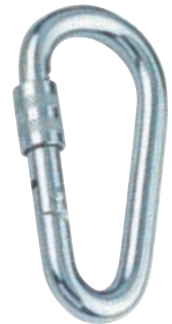
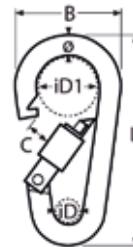

Schraubverbinder, Birnenform / A4-AISI 316

Quick link pear shaped / Maillon à visser, forme poire

8961

Artikel-Nr. Item-no.	ø	L	B	iD	iD1	C	**BL kg	Box	*€/Stück *€/piece
8961404 61	4	61	32	12	22	11	860	10	1,90
8961405 70	5	70	37	14	24	13	1450	10	3,30
8961406 82	6	77	42	15	28	14	1840	10	4,30
8961408 100	8	100	53	19	34	17	2940	10	6,40
8961410 118	10	118	63	22	35	20	5060	5	11,40
8961412 144	12	144	76	25	45	23	6460	5	17,70

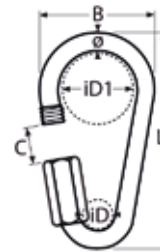

Karabinerhaken mit Sicherheitsverschluss / A4-AISI 316

Spring hook with safety latch / Mousqueton pompier avec fermeture de sécurité

8948

Artikel-Nr. Item-no.	ø	L	B	iD	iD1	C	iB	**BL kg	Box	*€/Stück *€/piece
8948406 60	6	60	30	8	18	7	6	250	10	2,60
8948408 80	8	80	40	12	24	10	9	590	10	3,90
8948410 100	10	100	50	15	29	12	10	600	5	10,50

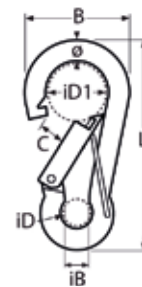

Karabinerhaken mit Sperre / A4-AISI 316

Spring hook with snap locking / Mousqueton avec sécurité

8338

Artikel-Nr. Item-no.	ø	L	B	iD	C	**BL kg	Box	*€/Stück *€/piece
8338410 110	10	110	62	20	19	890	5	15,50



1

Schäkel, Karabinerhaken und Wirbel

Shackles, spring hooks and swivels

Manilles, mousquetons et émerillons

8679

Bojen-Karabiner / A4-AISI 316

Mooring hook / Crochet d'amarrage



Artikel-Nr. Item-no.	L	B	iD	iD1	**BL kg	Box	*€/Stück *€/piece
86794108 63	108	63	21	35	600	5	16,50

Zum Öffnen und Schließen mit dem Bootshaken.

For opening and closing with the boat hook.

Pour ouverture et fermeture avec gaffe.

814387

Simplexhaken / A2-AISI 304

Simplex hook / Mousqueton simplex

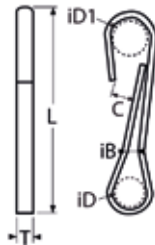

Artikel-Nr. Item-no.	L	iD	iD1	C	T	iB	Box	*€/Stück *€/piece
814387230	30	5,6	6,6	5,0	3,6	1,4	100	0,50
814387240	40	8,2	9,2	6,3	5,1	1,5	100	0,60
814387250	50	9,1	10,9	8,5	6,3	2,4	50	1,00
814387260	60	11,3	12,3	9,6	7,6	3,0	50	1,50

8251

Karabinerhaken "Surf Snap" / A4-AISI 316

Spring hook "surf-snap" / Mousqueton à œil "Surf Snap"



Artikel-Nr. Item-no.	L	B	iD	C	Box	*€/Stück *€/piece
NEW 82514030	30	15,5	4,5	8,5	10	1,80
NEW 82514040	40	20,0	5,5	9,0	10	2,00
82514050	50	24,0	7,0	10	10	2,10
82514070	70	30,0	10,0	13	10	3,10
82514100	100	44,0	15,0	20	5	6,90

814959

Alu-Karabinerhaken "Surf Snap" / Alu

Alu-spring hook "surf-snap" / Mousqueton à œil "Surf Snap" en alu



Artikel-Nr. Item-no.	Farbe Colour	L	B	iD	C	Box	*€/Stück *€/piece
814959054	Gemischt Mixed	54	23	10	14	10	2,30

Schäkel, Karabinerhaken und Wirbel

Shackles, spring hooks and swivels

Manilles, mousquetons et émerillons

1

1

Alu-S-Haken mit Sicherung / Alu

Alu-S-hook with safety latch / Crochet en S en alu avec linguet de sécurité

814958

Artikel-Nr. Item-no.	Farbe Colour	L	B	C	Box	*€/Stück *€/piece	
814958060	Gemischt / Mixed	60	30	13	10	2,70	
814958060BL	Blau / Blue	60	30	13	10	2,70	NEW
814958060RO	Rot / Red	60	30	13	10	2,70	NEW
814958060SI	Silber / Silver	60	30	13	10	2,70	NEW
814958060GE	Gelb / Yellow	60	30	13	10	2,70	NEW
814958060SC	Schwarz / Black	60	30	13	10	2,70	NEW
814958080	Gemischt / Mixed	80	40	16	10	3,60	
814958080BL	Blau / Blue	80	40	16	10	3,60	NEW
814958080RO	Rot / Red	80	40	16	10	3,60	NEW
814958080SI	Silber / Silver	80	40	16	10	3,60	NEW
814958080GE	Gelb / Yellow	80	40	16	10	3,60	NEW
814958080SC	Schwarz / Black	80	40	16	10	3,60	NEW



NEW

Kettenkarabinerhaken / A2-AISI 304

Chain snaps with double hook end / Mousqueton double

815155

Artikel-Nr. Item-no.	L	C	S	Box	*€/Stück *€/piece
815155206	75	12	6,8	10	5,50
815155208	98	14	9,4	10	7,70

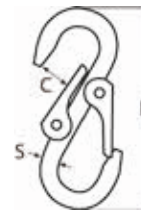

NEW

Kettenkarabinerhaken zum Einschlagen / A2-AISI 304

Chain snap to hammer in / Mousqueton à chaîne à enfoncer

815156

Artikel-Nr. Item-no.	L	C	C1	S	Box	*€/Stück *€/piece
815156206	49	10	8	6,8	10	5,20

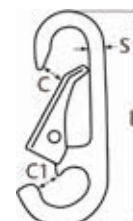

1

Schäkel, Karabinerhaken und Wirbel

Shackles, spring hooks and swivels

Manilles, mousquetons et émerillons

814844

Doppel-Karabinerhaken / A4-AISI 316

Double spring hook / Mousqueton double à œil

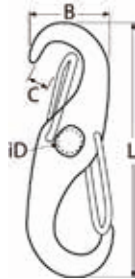

Artikel-Nr. Item-no.	L	B	iD	C	Box	*€/Stück *€/piece
8148444080	80	24	10	10	5	2,30
8148444110	110	31	13	12	5	4,90
8148444150	150	46	21	22	2	13,10

8533

Stagreiter / A4-AISI 316

Piston hank / Mousqueton de foc

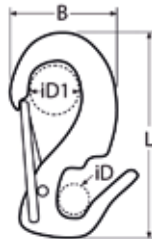

Artikel-Nr. Item-no.	L	B	iD	iD1	Box	*€/Stück *€/piece
8533450	50	25	6	7	10	1,80
NEW 8533455	55	29	8	9	10	2,80
8533465	65	35	10	11	10	3,10
8533490	90	49	13	17	5	7,50

814670

Alu-Karabinerhaken / Alu

Alu spring hook / Mousqueton asymétrique en alu

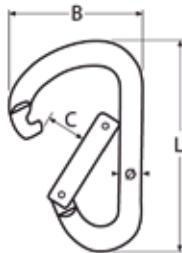

Artikel-Nr. Item-no.	ø	L	B	C	Box	*€/Stück *€/piece
814670012 116	12	117	75	24	5	15,60

814672

Alu-Karabinerhaken / Alu

Alu spring hook / Mousqueton asymétrique en alu

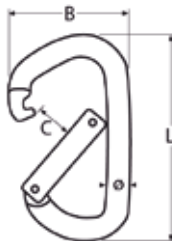

Artikel-Nr. Item-no.	ø	L	B	C	Box	*€/Stück *€/piece
814672012 111	12	112	67	21	5	11,80

Schäkel, Karabinerhaken und Wirbel

Shackles, spring hooks and swivels

Manilles, mousquetons et émerillons

1

1

Alu-Karabinerhaken / Alu

Alu spring hook / Mousqueton asymétrique en alu

814671

Artikel-Nr. Item-no.	ø	L	B	C	Box	*€/Stück *€/piece
814671011 100	11	100	59	25	5	12,40

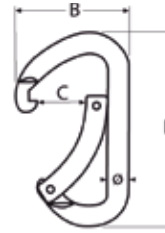

Alu-Karabinerhaken mit Sicherungsmutter / Alu

Alu spring hook with screw sleeve / Mousqueton asymétrique avec vis de sécurité en alu

814669

Artikel-Nr. Item-no.	ø	L	B	C	Box	*€/Stück *€/piece
814669012 113	12	113	63	19	5	16,00

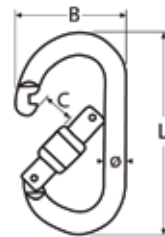

Alu-Karabinerhaken mit Sicherungsmutter / Alu

Alu spring hook with screw sleeve / Mousqueton asymétrique avec vis de sécurité en alu

814674

Artikel-Nr. Item-no.	ø	L	B	C	Box	*€/Stück *€/piece
814674012 116	12	117	75	22	5	16,10

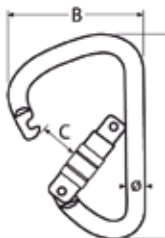

Alu-Karabinerhaken mit Sicherungsmutter / Alu

Alu spring hook with screw sleeve / Mousqueton asymétrique avec vis de sécurité en alu

814673

Artikel-Nr. Item-no.	ø	L	B	C	Box	*€/Stück *€/piece
814673012 111	12	112	67	19	5	18,00

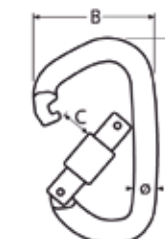

1

Schäkel, Karabinerhaken und Wirbel

Shackles, spring hooks and swivels

Manilles, mousquetons et émerillons

8493

Alu-Karabinerhaken mit Sicherungsmutter / Alu

Alu spring hook with screw sleeve / Mousqueton asymétrique avec vis de sécurité en alu

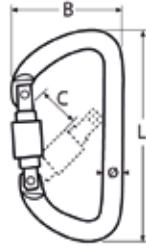

Artikel-Nr. Item-no.	Ø	L	B	C	Box	*€/Stück *€/piece
8493011 116	12	116	64	22	5	13,50

8490

Alu-Karabiner mit Drehverschluss / Alu

Alu spring hook with twist lock / Mousqueton avec fermeture 1/4 de tour en alu

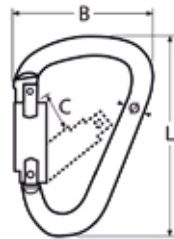

Artikel-Nr. Item-no.	Ø	L	B	C	Box	*€/Stück *€/piece
8490012 120	12	120	76	20	5	23,30

814960

Alu-Karabinerhaken mit Schlüsselringen / Alu / Stahl

Alu spring hook with key rings / Mousqueton en alu avec anneaux de porte-clé



Artikel-Nr. Item-no.	Farbe Colour	L	B	iD	C	Box	*€/Stück *€/piece
814960076BL	Blau / Blue	76	45	22	23	10	3,60
814960076SC	Schwarz / Black	76	45	22	23	10	3,60
814960076RO	Rot / Red	76	45	22	23	10	3,60
814960076SI	Silber / Silver	76	45	22	23	10	3,60
814960076OR	Orange / orange	76	45	22	23	10	3,60

Schäkel, Karabinerhaken und Wirbel

Shackles, spring hooks and swivels

Manilles, mousquetons et émerillons

1

1

Alu-Karabinerhaken mit Sicherungsmutter / Alu Alu spring hook with screw sleeve / Mousqueton en alu avec vis de sécurité à cœl

8494

Artikel-Nr. Item-no.	ø	L	B	iD	C	Box	*€/Stück *€/piece
84940130	16	130	80	21	21	5	14,60

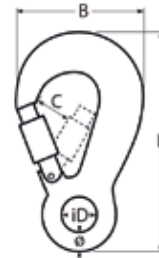

Trailerhaken / A4-AISI 316 Trailer hook / Croc de palan

8287

Artikel-Nr. Item-no.	ø	L	B	iD	C	**BL kg	Box	*€/Stück *€/piece
8287419	7	100	48	19	20	450	5	10,00
8287428	9	115	52	28	23	750	5	13,10



Trailerhaken mit Wirbel / A4-AISI 316 Trailer hook with swivel / Croc de palan à gachette

8971

Artikel-Nr. Item-no.	ø	L	B	iD	C	**BL kg	Box	*€/Stück *€/piece
8971428	7	147	69	28	18	2000	1	29,40
8971436	12	193	97	36	33	3700	1	54,40



Wirbelkarabiner / A4-AISI 316 Swivel eye bolt snap / Mousqueton targette à émerillon

8303

Artikel-Nr. Item-no.	ø	L	iD	iD1	C	Box	*€/Stück *€/piece
8303409	3	64	10	7	7	10	5,00
8303412	4	80	13	8	8	10	5,20
8303416	5	87	16	9	9	5	5,60
8303419	5	90	19	9	10	5	7,60
8303425	5	100	25	9	12	5	8,00



NEW

1

Schäkel, Karabinerhaken und Wirbel

Shackles, spring hooks and swivels

Manilles, mousquetons et émerillons

814977

Wirbelkarabiner mit rundem Auge / A4-AISI 316

Swivel eye bolt snap with round eye / Mousqueton à targette émerillon à œil rond

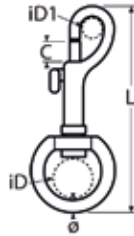

Artikel-Nr. Item-no.	ø	L	iD	iD1	C	Box	*€/Stück *€/piece
8149774105	6	105	22	13	13	5	7,50
8149774120	6	120	26	13	13	5	10,00

8257

Schnapphaken mit Wirbelauge / A4-AISI 316

Snap hook with swivel eye / Mousqueton à émerillon



Artikel-Nr. Item-no.	ø	L	iD1	C	Box	*€/Stück *€/piece
NEW 8257413	4,0	70	13	7	10	5,70
8257416	4,4	86	21	11	5	6,40
8257419	5,8	100	21	12	5	8,10
8257422	7,3	118	21	16	5	10,00

8534

Schnapphaken mit Wirbelauge / A4-AISI 316

Trigger snap with swivel eye / Mousqueton gachette à émerillon

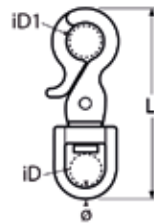

Artikel-Nr. Item-no.	ø	L	iD	iD1	Box	*€/Stück *€/piece
8534413	4,3	65	12	10	5	6,80

815071

Karabinerhaken Surf-Snap mit Wirbelauge, MT-Serie / A4-AISI 316

Spring hook Surf-Snap with swivel eye, MT-series / Mousqueton à œil Surf-Snap avec émerillon, MT-série



NEW



Artikel-Nr. Item-no.	L	B	iD	ø	C	Box	*€/Stück *€/piece
8150714045	45	15,5	9	3,0	8	10	4,30
8150714060	60	20,0	12	3,0	9	10	4,60
8150714070	70	24,0	14	4,0	10	5	4,80
8150714095	95	30,5	17	4,5	13	5	7,70
8150714130	130	46,5	22	6,5	20	2	12,20

Schäkel, Karabinerhaken und Wirbel

Shackles, spring hooks and swivels

Manilles, mousquetons et émerillons

1

1



Sprenger Schnapphaken mit Wirbelauge / A4-AISI 316

Sprenger snap hook with swivel eye / Mousqueton à émerillon Sprenger

814971

Artikel-Nr. Item-no.	L	iD	C	**BL kg	Box	*€/Stück *€/piece
8149712045	45	6,0	5	210	2	9,10
8149712056	56	8,0	6	260	2	9,40
8149712061	61	11,6	6	260	2	9,60
8149712075	75	9,2	11	500	2	15,10



Doppelkarabiner / A4-AISI 316

Double snap hook / Mousqueton à double targette

8416

Artikel-Nr. Item-no.	L	iD1	C	Box	*€/Stück *€/piece
84164090	90	8	9	5	7,20
84164100	100	10	11	5	7,30
84164115	115	11	10	5	8,00



Brummelhaken, Speedclip / A4-AISI 316

Flag hook / Crochet accélérateur

814656

Artikel-Nr. Item-no.	L	B	A	iD	Box	*€/Stück *€/piece
814656406	58	38	22,3	16	10	5,00

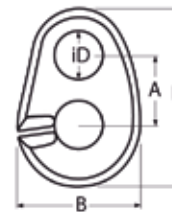

Seilspannklemme / Seilgreifer / A2-AISI 304

Rope tensioning clamp / Bloqueur de corde

8491

Artikel-Nr. Item-no.	Für Seil-Ø For Rope-Ø	L	B	iD	S	Box	*€/Stück *€/piece
8491212	12	122	78	22	5	1	38,00
8491216	16	122	78	22	5	1	39,50

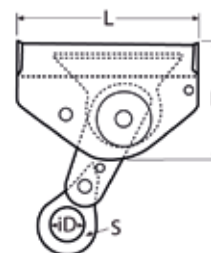

Schäkel, Karabinerhaken und Wirbel

Shackles, spring hooks and swivels

Manilles, mousquetons et émerillons

8258

Rundschäkel / A4-AISI 316

D-shackle / Manille droite

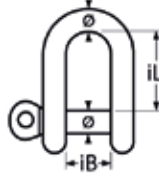

Artikel-Nr. Item-no.	ø	iL	iB	**BL kg	Box	*€/Stück *€/piece
8258403	3	11,0	7	500	50	1,20
8258404	4	14,0	8	700	50	1,30
8258405	5	17,5	10	1000	50	1,40
8258406	6	21,0	12	1500	50	1,70
8258407	7	24,5	14	2000	50	2,40
8258408	8	28,0	16	3000	50	2,60
8258410	10	35,0	20	4300	50	4,50
8258412	12	42,0	24	6600	50	5,50
8258413	13	45,5	26	9000	10	10,00
NEW 8258414	14	49,0	28	9500	10	12,20
8258416	16	56,0	32	10000	10	15,70
8258419	19	66,5	35	16000	1	30,00
8258422	22	77,0	44	20000	1	50,20
8258425	25	87,5	50	24000	1	73,30
NEW 8258428	28	98,0	56	29000	1	90,00
8258432	32	112,0	64	31000	1	120,70

815141

Rundschäkel "Secur" mit TX+Pin, MT-Serie / A4-AISI 316

D-shackle "Secur" with TX+Pin socket, MT series / Manille droite "Secur" avec hexalobulaire+broch, Série MT

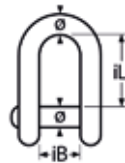
**NEW**

Artikel-Nr. Item-no.	ø	iL	iB	Antrieb Drive	**BL kg	Box	*€/Stück *€/piece
815141405	5	17,5	10	TX20+Pin	1000	10	2,50
815141406	6	21,0	12	TX25+Pin	1500	10	3,00
815141408	8	28,0	16	TX40+Pin	3000	10	5,00
815141410	10	35,0	20	TX45+Pin	4300	5	8,40
815141412	12	42,0	24	TX50+Pin	6600	5	12,60

Die Passenden Sicherheitsbolzen Art. 815143 finden Sie auf Seite 96

The suitable scure pins item 815143 you will find on page 96

Vous trouverez les blocs de sécurité correspondants art. 815143 à la page 96

Die Passenden Bits Art. 815000 und 815213 finden Sie auf Seite 417

The suitable bits item 815000 and 815213 you will find on page 417

Vous trouverez les embouts correspondants (art. 815000 et 815213) à la page 417

8326

Rundschäkel mit unverlierbarem Bolzen / A4-AISI 316

D-shackle with captive pin / Manille droite avec axe imperdable

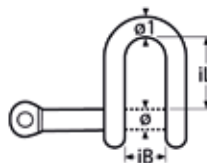

Artikel-Nr. Item-no.	ø	ø1	iL	iB	**BL kg	Box	*€/Stück *€/piece
8326404	4	3,5	14,0	8	700	10	2,40
8326405	5	4,4	17,5	10	1000	10	2,60
8326406	6	5,3	21,0	12	1500	10	2,90
8326408	8	7,1	28,0	16	3000	10	3,50
8326410	10	8,9	35,0	20	4300	5	4,90
8326412	12	10,8	42,0	24	6600	5	8,00

Schäkel, Karabinerhaken und Wirbel

Shackles, spring hooks and swivels

Manilles, mousquetons et émerillons

1

1

Rundschäkel mit Innensechskant / A4-AISI 316

D-shackle with hexagon socket / Manille droite avec vis six pans creux

8482

Artikel-Nr. Item-no.	ø	iL	iB	Antrieb Drive	**BL kg	Box	*€/Stück *€/piece
8482405	5	17,5	10	SW2,5	1000	10	2,00
8482406	6	21,0	12	SW3	1500	10	2,20
8482408	8	28,0	16	SW4	2400	10	3,00
8482410	10	35,0	20	SW5	3700	5	5,40
8482412	12	42,0	24	SW6	5400	5	8,20
8482414	14	48,0	28	SW6	6500	5	17,00
8482416	16	52,0	32	SW8	8800	5	20,70
8482419	19	63,0	38	SW10	16000	1	31,30
8482422	22	76,0	44	SW12	19000	1	53,00

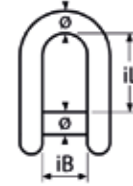

Rundschäkel mit Innensechskant und Sicherungsmutter / A4-AISI 316

D-Shackle with hexagon socket and safety nut / Manille droite avec axe HC et écrou de sécurité

814839

Artikel-Nr. Item-no.	ø	iL	iB	Antrieb Drive	Antrieb 1 Drive 1	**BL kg	Box	*€/Stück *€/piece
814839405	5	17,5	10	SW8	SW2,5	1000	10	2,60 NEW
814839406	6	21,0	12	SW10	SW3	1320	10	3,40
814839406-12	6	12,0	12	SW10	SW3	1320	10	4,50 NEW
814839408	8	28,0	16	SW13	SW4	2200	10	7,20 NEW
814839410	10	35,0	20	SW17	SW5	3700	5	8,00

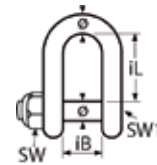

Rundschäkel mit Mutter und Splint / A4-AISI 316

D-shackle with nut and splint pin / Manille avec écrou et goupille

814069

Artikel-Nr. Item-no.	ø	ø1	iL	iB	Antrieb Drive	**BL kg	Box	*€/Stück *€/piece
8140694048	6,4	5	19	9,7	SW10	1320	10	3,20
8140694064	8,0	6	22	12,0	SW13	2000	10	3,90
814069408	9,5	8	26	13,5	SW17	3000	10	7,10
8140694095	11,0	10	32	17,0	SW19	4000	5	8,80
8140694127	16,0	12	41	21,0	SW24	8000	5	17,30
814069416	19,0	16	51	27,0	SW30	12000	5	33,80
814069419	22,0	20	60	32,0	SW32	16000	1	51,90
814069422	25,0	22	71	36,0	SW36	20000	1	65,60

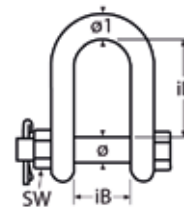

NEW

Rundschäkel, weit mit unverlierbarem Bolzen / A4-AISI 316

D-shackle, wide with captive pin / Manille large avec axe imperdable

815102

Artikel-Nr. Item-no.	ø	ø1	iL	iB	**BL kg	Box	*€/Stück *€/piece
815102405	5	4,4	22	25	750	10	2,80
815102406	6	5,3	33	24	1200	10	3,40
815102408	8	7,1	32	28	2150	10	5,40
815102410	10	8,9	55	40	3350	5	8,10
815102412	12	10,8	66	50	4000	5	14,60

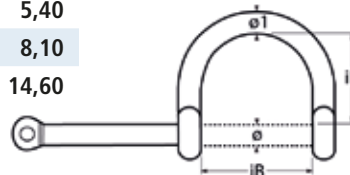

1

Schäkel, Karabinerhaken und Wirbel

Shackles, spring hooks and swivels

Manilles, mousquetons et émerillons

814737

Alu-Rundschäkel / Alu

Alu D-shackle / Manille droite en alu



Artikel-Nr. Item-no.	ø	iL	iB	Box	*€/Stück *€/piece
8147370058	6	21,0	12,3	10	2,00
8147370078	8	28,6	16,5	10	3,60
8147370098	10	35,0	20,0	5	3,90
8147370118	12	43,0	25,0	5	5,90

Farben: rot, blau, lila, gelb und grün gemischt.

Colours: red, blue, purple, yellow and green mixed.

Couleurs: rouge, bleu, violet, jaune et vert mixte.

8259

Rundschäkel, lang / A4-AISI 316

D-shackle, long / Manille longue

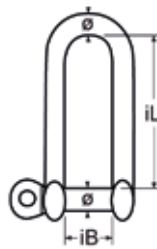

NEW

Artikel-Nr. Item-no.	ø	iL	iB	**BL kg	Box	*€/Stück *€/piece
8259404	4	30,0	8	700	10	1,80
8259405	5	37,5	10	1000	10	2,20
8259406	6	45,0	12	1500	10	2,50
8259408	8	60,0	16	3000	10	3,50
8259410	10	75,0	20	4300	5	5,90
8259412	12	90,0	24	6600	5	9,20
8259416	16	120	32	10000	5	25,80

815145

Rundschäkel "Secur", lang, mit TX+Pin, MT-Serie / A4-AISI 316

D-shackle "Secur", long, TX+Pin socket, MT series / Manille longue "Secur", hexaloblaire+broch, Série MT



NEW



Artikel-Nr. Item-no.	ø	iL	iB	Antrieb Drive	**BL kg	Box	*€/Stück *€/piece
815145405	5	37,5	10	TX20+Pin	1000	10	3,60
815145406	6	45,0	12	TX25+Pin	1500	10	4,00
815145408	8	60,0	16	TX40+Pin	3000	10	6,20
815145410	10	75,0	20	TX45+Pin	4300	5	8,70
815145412	12	90,0	24	TX50+Pin	6600	5	14,80

Die Passenden Sicherheitsbolzen Art. 815143 finden Sie auf Seite 96

The suitable scure pins item 815143 you will find on page 96

Vous trouverez les blocs de sécurité correspondants art. 815143 à la page 96

Die Passenden Bits Art. 815000 und 815213 finden Sie auf Seite 417

The suitable bits item 815000 and 815213 you will find on page 417

Vous trouverez les embouts correspondants (art. 815000 et 815213) à la page 417

Schäkel, Karabinerhaken und Wirbel

Shackles, spring hooks and swivels

Manilles, mousquetons et émerillons

1

1

Rundschäkel, lang mit unverlierbarem Bolzen / A4-AISI 316

Long D-shackle with captive pin / Manille longue avec axe imperdable

8331

Artikel-Nr. Item-no.	ø	ø1	iL	iB	**BL kg	Box	*€/Stück *€/piece
8331405	5	4,4	37,5	10	1000	10	3,40
8331406	6	5,3	45,0	12	1500	10	3,70
8331408	8	7,1	60,0	16	3000	10	4,90
8331410	10	8,9	75,0	20	4300	5	7,20
8331412	12	10,8	90,0	24	6600	5	10,90

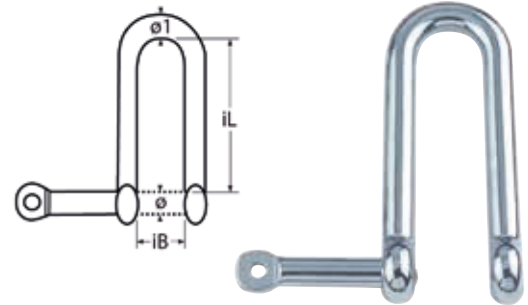

Flachschäkel / A4-AISI 316

Flat shackle / Manille plate, courte

8297

Artikel-Nr. Item-no.	ø	iL	iB	S	**BL kg	Box	*€/Stück *€/piece
829744	4	18	10	1,9	800	10	1,50
829745	5	20	12	2,0	900	10	1,70
829746	6	24	16	3,2	1500	10	1,90
829748	8	45	21	3,9	1950	10	4,20

NEW

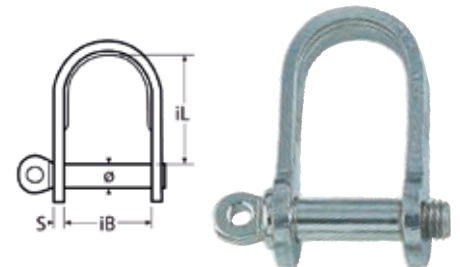

Flachschäkel, lang / A4-AISI 316

Flat shackle, long / Manille plate, longue

8298

Artikel-Nr. Item-no.	ø	iL	iB	S	**BL kg	Box	*€/Stück *€/piece
829844	4	24	12	1,9	800	10	2,00
829845	5	21	12	2,0	900	10	2,30
829846	6	26	16	3,2	1500	10	3,00

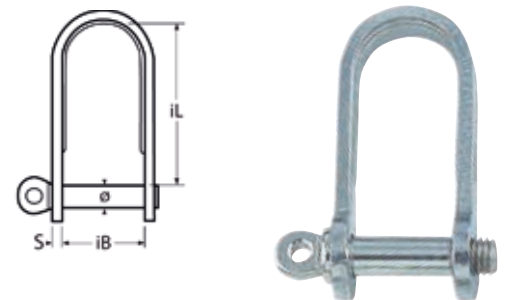

Flachschäkel, gerundet / A4-AISI 316

Flat shackle, semi-round / Manille plate, semi ronde

8337

Artikel-Nr. Item-no.	ø	iL	iB	S	**BL kg	Box	*€/Stück *€/piece
833745	5	18,5	12	2,6	400	10	2,60
833746	6	22,0	14	3,0	500	10	2,80
833748	8	28,0	18	3,7	900	10	3,90

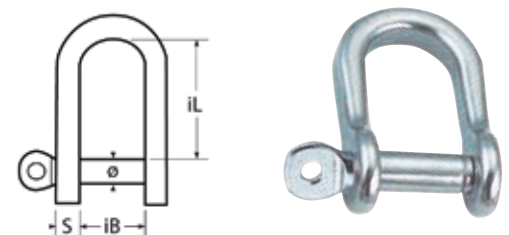

1

Schäkel, Karabinerhaken und Wirbel

Shackles, spring hooks and swivels

Manilles, mousquetons et émerillons

8969

Rundschäkel, weit / A4-AISI 316

D-shackle, wide / Manille large

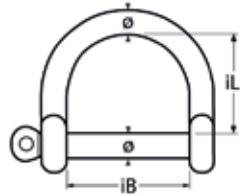

Artikel-Nr. Item-no.	ø	iL	iB	**BL kg	Box	*€/Stück *€/piece
8969405	5	22	25	750	10	2,50
8969406	6	33	24	1200	10	3,10
8969408	8	32	26	2150	10	4,50
8969410	10	55	40	3350	5	7,40
8969412	12	66	50	4000	5	13,50

8260

Rundschäkel, geschweift / A4-AISI 316

Bow shackle / Manille lyre

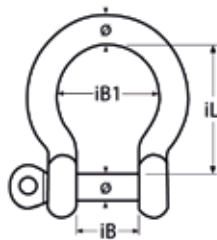

NEW

NEW

Artikel-Nr. Item-no.	ø	iL	iB	iB1	**BL kg	Box	*€/Stück *€/piece
8260403	3	10,0	6	10	500	20	1,30
8260404	4	14,0	8	14	800	20	1,40
8260405	5	17,0	10	17	1200	20	1,50
8260406	6	21,0	12	21	1800	20	1,70
8260408	8	28,0	16	28	2800	10	3,20
8260410	10	35,0	20	35	4300	10	4,10
8260412	12	42,0	24	42	6500	5	8,20
8260413	13	45,0	26	45	7500	5	9,60
8260416	16	56,0	32	56	10000	5	19,40
8260419	19	66,0	38	66	16000	1	35,40
8260422	22	77,0	44	77	21000	1	44,80
8260425	25	87,5	50	87	22300	1	85,00

815142

Rundschäkel "Secur", geschweift, mit TX+Pin, MT-Serie / A4-AISI 316

Bow shackle "Secur", TX+Pin socket, MT series / Manille lyre "Secur", hexalobulaire+broch, Série MT



NEW

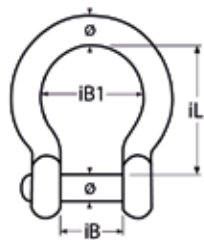

Artikel-Nr. Item-no.	ø	iL	iB	iB1	Antrieb Drive	**BL kg	Box	*€/Stück *€/piece
815142405	5	17,5	10	17	TX20+Pin	1000	10	2,90
815142406	6	21,0	12	21	TX25+Pin	1500	10	3,40
815142408	8	28,0	16	28	TX40+Pin	3000	10	5,70
815142410	10	35,0	20	35	TX45+Pin	4300	5	8,00
815142412	12	42,0	24	42	TX50+Pin	6600	5	13,70

Die Passenden Sicherheitsbolzen Art. 815143 finden Sie auf Seite 96

The suitable scure pins item 815143 you will find on page 96

Vous trouverez les blocs de sécurité correspondants art. 815143 à la page 96

Die Passenden Bits Art. 815000 und 815213 finden Sie auf Seite 417

The suitable bits item 815000 and 815213 you will find on page 417

Vous trouverez les embouts correspondants (art. 815000 et 815213) à la page 417

Schäkel, Karabinerhaken und Wirbel

Shackles, spring hooks and swivels

Manilles, mousquetons et émerillons

1

1

Rundschäkel, geschweißt mit unverlierbarem Bolzen / A4-AISI 316

Bow shackle with captive pin / Manille lyre avec axe imperdable

8222

Artikel-Nr. Item-no.	ø	ø1	iL	iB	iB1	**BL kg	Box	*€/Stück *€/piece
8222404	4	3,5	14,0	8	14	800	10	2,50
8222405	5	4,4	17,5	10	17	1200	10	2,90
8222406	6	5,3	21,0	12	21	1800	10	3,40
8222408	8	7,1	28,0	16	28	2800	10	4,00
8222410	10	8,9	35,0	20	34	4300	5	6,20
8222412	12	10,8	42,0	24	42	5000	5	9,30

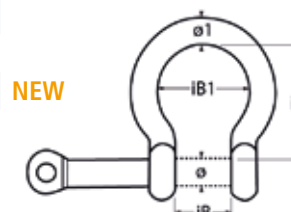

NEW

Rundschäkel, geschweißt mit Innensechskant / A4-AISI 316

Bow shackle with hexagon socket / Manille lyre avec vis six pans creux

8970

Artikel-Nr. Item-no.	ø	iL	iB	iB1	Antrieb Drive	**BL kg	Box	*€/Stück *€/piece
8970404	4	18	8	15	SW2	550	10	3,60
8970405	5	22	10	17	SW3	1200	10	4,70
8970406	6	26	12	21	SW3	1700	10	4,90
8970408	8	36	16	28	SW4	2500	10	5,20
8970410	10	43	20	34	SW5	4300	5	8,50
8970412	12	52	25	42	SW8	5500	5	11,30
8970413	13	60	26	42	SW8	6300	5	15,00
8970416	16	73	30	56	SW10	7000	5	34,00
8970419	19	87	36	66	SW12	14000	1	58,00

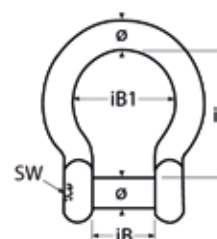

NEW

NEW

Rundschäkel, geschweißt mit Mutter und Splint / A4-AISI 316

Bow shackle with nut and split pin / Manille lyre avec écrou et goupille

814068

Artikel-Nr. Item-no.	ø	ø1	iL	iB	iB1	Antrieb Drive	**BL kg	Box	*€/Stück *€/piece
8140684048	6,4	5	22	9,7	16	SW10	1320	10	2,90
8140684064	8,0	6	29	12,0	20	SW13	2000	10	4,20
814068408	9,5	8	31	13,5	21	SW17	3000	10	5,80
8140684095	11,0	10	36	17,0	26	SW19	4000	5	9,50
8140684127	16,0	12	48	21,0	33	SW24	8000	5	14,80
814068416	19,0	16	60	27,0	42	SW30	12000	5	35,20
814068419	22,0	20	71	32,0	52	SW32	16000	1	55,50
814068422	25,0	22	84	36,0	57	SW36	20000	1	95,40

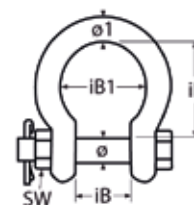

1

Schäkel, Karabinerhaken und Wirbel

Shackles, spring hooks and swivels

Manilles, mousquetons et émerillons

8296

Rundschäkel, 90° gedreht / A4-AISI 316

Twisted shackle 90° / Manille, torsé 90°

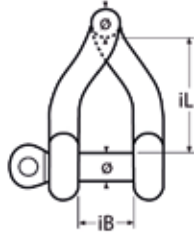

Artikel-Nr. Item-no.	ø	iL	iB	**BL kg	Box	*€/Stück *€/piece
8296404	4	22	8	700	10	2,10
8296405	5	27	10	1000	10	2,30
8296406	6	33	12	1500	10	2,60
8296408	8	44	16	3000	10	4,50
8296410	10	55	20	4300	5	6,00
8296412	12	66	24	6600	5	10,60

815146

Rundschäkel "Secur", 90° gedreht, mit TX+Pin, MT-Serie / A4-AISI 316

Twisted shackle "Secur" 90°, TX+Pin socket, MT series / Manille "Secur", torsé 90°, hexalobulaire+broch, Série MT



NEW

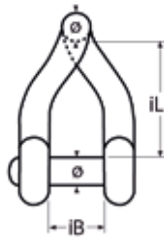

Artikel-Nr. Item-no.	ø	iL	iB	Antrieb Drive	**BL kg	Box	*€/Stück *€/piece
815146405	5	27	10	TX20 Pin	1000	10	3,20
815146406	6	33	12	TX25 Pin	1500	10	4,30
815146408	8	44	16	TX40 Pin	3000	10	7,40
815146410	10	55	20	TX45 Pin	4300	5	9,80
815146412	12	66	24	TX50 Pin	6600	5	16,60

Die Passenden Sicherheitsbolzen Art. 815143 finden Sie auf Seite 96

The suitable scure pins item 815143 you will find on page 96

Vous trouverez les blocs de sécurité correspondants art. 815143 à la page 96

Die Passenden Bits Art. 815000 und 815213 finden Sie auf Seite 417

The suitable bits item 815000 and 815213 you will find on page 417

Vous trouverez les embouts correspondants (art. 815000 et 815213) à la page 417

814946

Rundschäkel, 90° gedreht mit unverlierbarem Bolzen / A4-AISI 316

Twisted shackle 90° with captive pin / Manille, torsé 90° avec axe imperdable

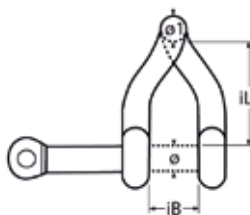

Artikel-Nr. Item-no.	ø	ø1	iL	iB	**BL kg	Box	*€/Stück *€/piece
814946404	4	3,5	22,0	8	700	10	2,60
814946405	5	4,4	27,5	10	1000	10	3,00
814946406	6	5,3	33,0	12	1500	10	3,40
814946408	8	7,1	44,0	16	3000	10	4,80
814946410	10	8,9	55,0	20	4300	5	7,90
814946412	12	10,8	66,0	24	6600	5	15,00

8299

Flatschäkel, 90° gedreht / A4-AISI 316

Flat shackle 90°, twisted / Manille plate, torsé 90°

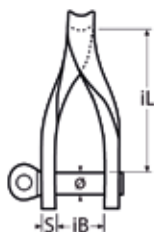

Artikel-Nr. Item-no.	ø	iL	iB	S	**BL kg	Box	*€/Stück *€/piece
829944	4	24	11	2,0	800	10	3,60
829945	5	40	12	2,6	900	10	3,80

Schäkel, Karabinerhaken und Wirbel

Shackles, spring hooks and swivels

Manilles, mousquetons et émerillons

1

1

Schäkelschlüssel, gestanz / A2-AISI 304
Multi-purpose shackle key, stamped / Démanilleur, estampée

8306

Artikel-Nr. Item-no.	L	iD	S	Box	*€/Stück *€/piece
83062100	100	4,7	2	5	3,00



Schäkelschlüssel, gegossen / A4-AISI 316
Multi-purpose shackle key, casted / Démanilleur, moulé

8977

Artikel-Nr. Item-no.	L	iD	S	Box	*€/Stück *€/piece
8977405	86	7	5	10	2,80



Schlüsselschäkel / A4-AISI 316
Key pin shackle / Manille longue rapide

8324

Artikel-Nr. Item-no.	ø	iL	iB	**BL kg	Box	*€/Stück *€/piece
832445	5	37,5	12	950	10	3,60
832446	6	45,0	15	1360	10	4,70
832448	8	60,5	20	2270	10	7,40



Schlüsselschäkel mit festem Steg / A4-AISI 316
Key pin shackle with fixed bar / Manille longue rapide à barette

8323

Artikel-Nr. Item-no.	ø	ø1	iL	iL1	iB	**BL kg	Box	*€/Stück *€/piece
832345	5	6,0	37,5	12,5	12	950	10	3,90
832346	6	6,0	45,0	15,0	15	1360	10	5,10
832348	8	6,5	60,0	20,0	20	2270	10	7,80

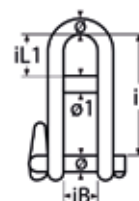

1

Schäkel, Karabinerhaken und Wirbel

Shackles, spring hooks and swivels

Manilles, mousquetons et émerillons

815154

Fallschäkel mit Steg / A4-AISI 316

Headboard shackle with cross bar / Manille de drisse avec pont

NEW

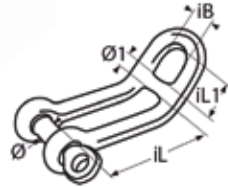

Artikel-Nr. Item-no.	ø	ø1	iL	iL1	iB	**BL kg	Box	*€/Stück *€/piece
815154406	7	4	31	11	12	1900	10	5,20
815154408	8	6	42	15	16	3700	10	8,30
815154410	11	7	52	18	20	5200	5	14,50
815154412	12	9	63	22	24	6500	5	22,00

8288

Schnappschäkel / A4-AISI 316

Snap shackle / Mousqueton de drisse

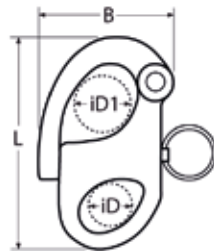

Artikel-Nr. Item-no.	L	B	iD	iD1	**BL kg	Box	*€/Stück *€/piece
8288435	35	23	6	9	200	5	4,50
8288445	45	29	8	10	770	5	5,20
8288452	52	35	9	13	1100	5	6,50
8288466	66	45	12	16	1430	5	8,20
8288496	96	60	16	22	1790	5	12,80

8252

Schnappschäkel mit Wirbelauge / A4-AISI 316

Snap shackle with swivel eye / Mousqueton de drisse avec émerillon à œil

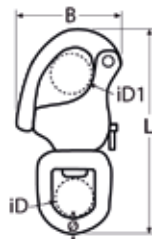

Artikel-Nr. Item-no.	ø	L	B	iD	iD1	**BL kg	Box	*€/Stück *€/piece
82524070	5	70	33	12	13	790	5	6,50
82524087	6	87	42	22	16	930	5	9,40
82524128	9	128	58	22	22	2000	5	17,30

Schäkel, Karabinerhaken und Wirbel

Shackles, spring hooks and swivels

Manilles, mousquetons et émerillons

1

1

Schnappschäkel mit Wirbelschäkel / A4-AISI 316

Snap shackle with swivel shackle / Mousqueton de drisse avec émerillon à chape

8262

Artikel-Nr. Item-no.	ø	L	iL	B	iB	iD1	**BL kg	Box	*€/Stück *€/piece
82624070	5	68	10	33	10	13	780	5	7,90
82624087	6	87	12	42	12	16	910	5	11,90
82624128	10	128	20	58	20	22	1800	5	23,50



Schnappschäkel mit Schraube / A4-AISI 316

Snap shackle with screw / Mousqueton de drisse à vis

8289

Artikel-Nr. Item-no.	GW	L1	B	iD1	**BL kg	Box	*€/Stück *€/piece
8289406	M6	42	30	12	650	5	6,60
8289408	M8	53	40	16	750	5	8,00
8289410	M10	75	62	22	1600	5	20,60

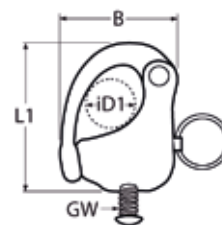

Schotschäkel, Fallschäkel / A4-AISI 316

Sheet snap shackle / Mousqueton d'écoute

8290

Artikel-Nr. Item-no.	L	iD	iD1	**BL kg	Box	*€/Stück *€/piece
8290452	52	12	14	630	5	6,20
8290466	66	15	17	930	5	9,20
8290496	96	25	24	1610	5	21,10

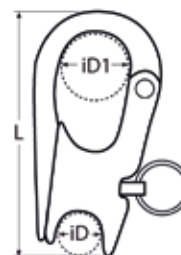

Panikhaken, Wasserskihaken / A4-AISI 316

Panic hook, Waterski hook / Mousqueton ski nautique

8485

Artikel-Nr. Item-no.	ø	L	B	iD	iD1	**BL kg	Box	*€/Stück *€/piece
8485460	5,3	60	37	16	17	440	5	9,80

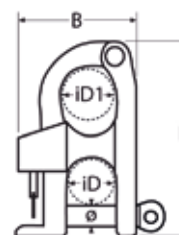

1

Schäkel, Karabinerhaken und Wirbel

Shackles, spring hooks and swivels

Manilles, mousquetons et émerillons

8254

Wirbel, Auge-Auge / A4-AISI 316

Swivel eye-eye / Emerillon œil-œil

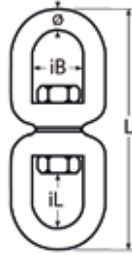

	Artikel-Nr. Item-no.	ø	L	iL	iB	**BL kg	Box	*€/Stück *€/piece
NEW	8254404	4	44	9	9	340	10	3,10
	8254405	5	55	12	12	790	10	3,60
	8254406	6	66	15	15	1130	10	4,20
	8254408	8	88	20	20	2000	10	6,10
	8254410	10	110	25	25	3170	5	9,00
	8254413	13	143	32	32	4570	1	23,90
	8254416	16	176	40	40	8130	1	34,60
	8254419	19	231	47	47	10000	1	63,50
NEW	8254422	22	242	55	55	10700	1	153,00
NEW	8254425	25	275	62	62	13060	1	232,70

8255

Wirbelschäkel, Auge-Gabel / A4-AISI 316

Swivel shackle eye-jaw / Emerillon œil-chape

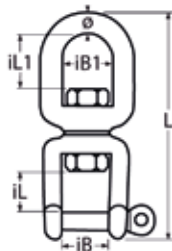

	Artikel-Nr. Item-no.	ø	L	iL	iL1	iB	iB1	**BL kg	Box	*€/Stück *€/piece
NEW	8255404	4	44	8	10	8	10	450	10	3,70
	8255405	5	55	10	12	10	12	600	10	4,20
	8255406	6	66	12	15	12	15	1130	10	4,70
	8255408	8	88	16	20	16	20	2000	10	7,20
	8255410	10	110	20	25	20	25	3150	5	9,50
	8255413	13	143	26	32	26	32	4550	1	25,70
	8255416	16	176	32	40	32	40	7500	1	36,20
	8255419	19	209	38	47	38	47	10000	1	70,50

815147

Wirbelschäkel "Secur" Auge-Gabel mit TX+Pin, MT-Serie / A4-AISI 316

Swivel shackle "Secur" eye-jaw, TX+Pin socket, MT series / Emerillon œil -chape "Secur", hexalobulaire+broch, Série MT



NEW

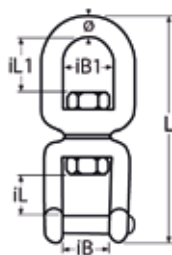

	Artikel-Nr. Item-no.	ø	L	iL	iL1	iB	iB1	Antrieb Drive	**BL kg	Box	*€/Stück *€/piece
	815147405	5	55	10	12	10	12	TX20 Pin	600	10	4,20
	815147406	6	66	12	15	12	15	TX25 Pin	1130	10	5,40
	815147408	8	88	16	20	16	20	TX40 Pin	2000	10	10,50
	815147410	10	110	20	25	20	25	TX45 Pin	3150	5	17,40

Die Passenden Sicherheitsbolzen Art. 815143 finden Sie auf Seite 96

The suitable scure pins item 815143 you will find on page 96

Vous trouverez les blocs de sécurité correspondants art. 815143 à la page 96

Die Passenden Bits Art. 815000 und 815213 finden Sie auf Seite 417

The suitable bits item 815000 and 815213 you will find on page 417

Vous trouverez les embouts correspondants (art. 815000 et 815213) à la page 417

Schäkel, Karabinerhaken und Wirbel

Shackles, spring hooks and swivels

Manilles, mousquetons et émerillons

1

1

Wirbelschäkel, Auge-Gabel mit Innensechskant / A4-AISI 316

Swivel shackle eye-jaw with hexagon socket / Emerillon œil-chape avec vis six pans creux

814105

Artikel-Nr. Item-no.	ø	L	iL	iL1	iB	iB1	Antrieb Drive	**BL kg	Box	*€/Stück *€/piece
814105405	5	55	10	12	10	12	SW2,5	600	10	3,70
814105406	6	66	12	15	12	15	SW3	1130	10	4,70
814105408	8	88	16	20	16	20	SW4	2000	10	9,10
814105410	10	110	20	25	20	25	SW5	3150	5	14,50
814105413	13	143	26	32	26	32	SW6	4550	1	32,00
814105416	16	176	32	40	34	40	SW8	7500	1	49,20
814105419	19	209	38	47	38	47	SW9	10000	1	77,50

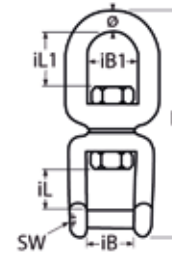

Wirbelschäkel Gabel-Gabel / A4-AISI 316

Swivel shackle jaw-jaw / Emerillon chape-chape

8256

Artikel-Nr. Item-no.	ø	L	iL	iB	**BL kg	Box	*€/Stück *€/piece
8256404	4	44	8	8	450	10	3,90
8256405	5	55	10	10	600	10	4,20
8256406	6	66	12	12	1130	10	4,80
8256408	8	88	16	16	2000	10	5,60
8256410	10	110	20	20	3150	5	11,50
8256413	13	143	26	26	4550	1	30,50
8256416	16	176	32	32	7500	1	42,70
8256419	19	209	38	38	10000	1	75,00



Wirbelschäkel "Secur" Gabel-Gabel mit TX+Pin, MT-Serie / A4-AISI 316

Swivel shackle "Secur" jaw-jaw, TX+Pin socket, MT series / Emerillon chape -chape "Secur", hexalobulaire+broch, Série MT

815148

Artikel-Nr. Item-no.	ø	L	iL	iB	Antrieb Drive	**BL kg	Box	*€/Stück *€/piece
815148405	5	55	10	12	TX20 Pin	600	10	4,30
815148406	6	66	12	15	TX25 Pin	1130	10	6,00
815148408	8	88	16	20	TX40 Pin	2000	10	8,10
815148410	10	110	20	25	TX45 Pin	3150	5	17,50



Die Passenden Sicherheitsbolzen Art. 815143 finden Sie auf Seite 96

The suitable scure pins item 815143 you will find on page 96

Vous trouverez les blocs de sécurité correspondants art. 815143 à la page 96

Die Passenden Bits Art. 815000 und 815213 finden Sie auf Seite 417

The suitable bits item 815000 and 815213 you will find on page 417

Vous trouverez les embouts correspondants (art. 815000 et 815213) à la page 417

Schäkel, Karabinerhaken und Wirbel

Shackles, spring hooks and swivels

Manilles, mousquetons, emerillons

8535

Wirbelschäkel Gabel-Gabel mit Innensechskant / A4-AISI 316

Swivel shackle jaw-jaw with hexagon socket / Emerillon chape-chape avec vis six pans creux

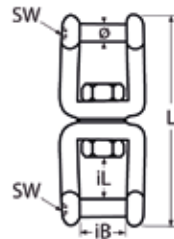

Artikel-Nr. Item-no.	ø	L	iL	iB	Antrieb Drive	**BL kg	Box	*€/Stück *€/piece
8535405	5	55	10	10	SW2,5	600	10	4,50
8535406	6	66	12	12	SW3	1130	10	5,60
8535408	8	88	16	16	SW4	2000	10	9,30
8535410	10	110	20	20	SW5	3150	5	15,00
8535413	13	143	26	26	SW6,5	4550	1	32,60
8535416	16	176	32	32	SW7	7500	1	55,40
8535419	19	209	38	38	SW9,5	10000	1	82,20

814840

Wirbelschäkel Gabel-Gabel mit Sicherungsmutter / A4-AISI 316

Swivel shackle jaw-jaw with lock nut / Emerillon chape-chape avec écrou de sécurité

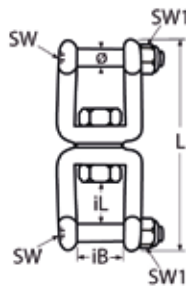

Artikel-Nr. Item-no.	ø	L	iL	iB	Antrieb Drive	Antrieb 1 Drive 1	**BL kg	Box	*€/Stück *€/piece
814840406	6	66	12	12	SW3	SW10	1130	10	5,70
814840408	8	88	16	16	SW4	SW13	2000	10	12,90

8364

Wirbelschäkel flach Gabel-Gabel / A2-AISI 304

Flat swivel shackle jaw-jaw / Emerillon plat chape-chape

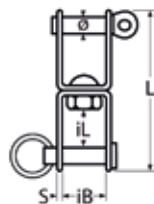

Artikel-Nr. Item-no.	ø	L	iL	iB	S	Box	*€/Stück *€/piece
8364212 47	5	47	10	12	2,0	10	12,70
8364214 55	6	62	11	14	2,5	10	14,10

815143

Schäkelersatzbolzen "Secur" mit TX+Pin, MT-Serie / A4-AISI 316

Shackle replacement bolt "Secur" with TX+Pin, MT series / Boulon de remplacement "Secur" TX+broche, Série MT



NEW



Artikel-Nr. Item-no.	GW	L	Antrieb Drive	Box	*€/Stück *€/piece
815143405	M5	20	TX20 Pin	10	1,10
815143406	M6	24	TX25 Pin	10	1,20
815143408	M8	32	TX40 Pin	10	1,90
815143410	M10	40	TX45 Pin	5	3,00
815143412	M12	48	TX50 Pin	5	3,90

Die Passenden Bits Art. 815000 und 815213 finden Sie auf Seite 417

The suitable bits item 815000 and 815213 you will find on page 417

Vous trouverez les embouts correspondants (art. 815000 et 815213) à la page 417

Spannschlösser, Terminals und Drahtseile

Turnbuckles, terminals and wire ropes

Tendeurs, ridoirs, embouts à sertir et câbles

Kapitel 2

Chapter 2



Drahtseil

Wire ropes
Câbles



Kauschen

Thimbles
Cosse-cœurs



Spannschlösser + Wantenspanner

Turnbuckles
Tendeurs et Ridoirs



Bolzen, Muttern + Schrauben

Pins + screws + nuts
Boulons + vis + écrous



Terminals

Terminals
Terminaisons



Werkzeuge

Tools
Outils



Drahtseilklemmen

Wire rope clips
Serre-câbles

2

Spannschlösser, Terminals und Drahtseile

Turnbuckles, terminals and wire ropes

Tendeurs, ridoirs, embouts à sertir et câbles

8245

Wantenspanner, Gabel-Gabel / A4-AISI 316

Turnbuckle fork-fork / Ridoir à chapes

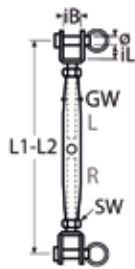

Artikel-Nr. Item-no.	GW	ø	L1	L2	iB	iL	Antrieb Drive	**BL kg	Box	*€/Stück *€/piece
8245404	M4	4	170	110	5,5	8	SW7	480	10	5,00
8245405	M5	5	190	130	6,5	10	SW7	790	10	6,00
8245406	M6	6	220	150	7,5	10	SW8	1100	10	7,00
8245408	M8	8	240	165	11,0	11	SW10	1750	10	12,00
8245410	M10	9	280	190	12,0	14	SW13	3100	5	17,00
8245412	M12	12	360	245	14,0	20	SW17	4570	5	29,00
8245414	M14	12	390	270	15,0	22	SW19	5900	1	35,00
8245416	M16	16	450	310	17,0	26	SW22	8000	1	62,00
8245420	M20	19	510	360	20,0	30	SW27	12700	1	104,00
NEW 8245422	M22	22	740	470	30,0	46	SW30	13500	1	190,00
NEW 8245424	M24	25	840	520	30,0	49	SW32	14000	1	280,00

Einzelteile Art.: 8418, 8386, 8432

Seperate parts art.: 8418, 8386, 8432

Pièces individuelles art.: 8418, 8386, 8432

815037

Wantenspanner, Auge-Auge / A4-AISI 316

Turnbuckle eye-eye / Ridoir œil-œil

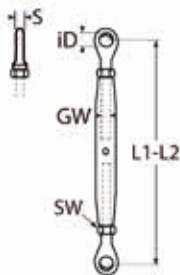

Artikel-Nr. Item-no.	GW	iD	L1	L2	S	Antrieb Drive	**BL kg	Box	*€/Stück *€/piece
815037404	M4	5,5	170	100	3	SW7	480	10	6,20
815037405	M5	5,5	190	120	3	SW7	630	10	6,60
815037406	M6	6,5	210	135	4	SW8	910	10	9,50
815037408	M8	8,5	240	160	5	SW10	1430	10	11,50
815037410	M10	10,5	280	190	6	SW13	2410	5	14,00
815037412	M12	13,0	340	225	8	SW17	3140	5	22,50
815037414	M14	13,0	380	250	9	SW19	4320	1	26,20
815037416	M16	14,5	420	275	10	SW22	5510	1	42,00
815037420	M20	19,5	480	330	15	SW27	9900	1	79,50

Einzelteile Art.: 8418, 814863, 814864

Seperate parts art.: 8418, 814863, 814864

Pièces individuelles art.: 8418, 814863, 814864

Spannschlösser, Terminals und Drahtseile

Turnbuckles, terminals and wire ropes

Tendeurs, ridoirs, embouts à sertir et câbles

2

Wantenspanner, Gabel-Terminal / A4-AISI 316

Turnbuckle fork-terminal / Ridoir chape à sertir

8275

Artikel-Nr. Item-no.	GW	DS-Ø WR-Ø	ø	L1	L2	iL	iL1	iB	D1	Antrieb Drive	Box	*€/Stück *€/piece
8275405/2	M5	2,0	5	215	155	10	32	6,5	5,5	SW7	10	6,60
8275405/25	M5	2,5	5	215	155	10	32	6,0	5,5	SW7	10	7,00
8275406/3	M6	3,0	6	245	175	10	39	7,5	6,4	SW8	10	7,50
8275406/4	M6	4,0	6	255	185	10	45	7,5	7,5	SW8	10	8,50
8275408/4	M8	4,0	8	275	200	11	45	11,0	7,5	SW10	10	9,00
8275408/5	M8	5,0	8	280	205	11	52	11,0	9,0	SW10	10	12,00
8275410/5	M10	5,0	9	320	230	14	52	12,0	9,0	SW13	5	17,00
8275410/6	M10	6,0	9	335	245	14	64	12,0	12,6	SW13	5	20,30
8275412/6	M12	6,0	12	400	285	20	64	14,0	12,6	SW17	5	29,00
8275412/8	M12	8,0	12	420	305	20	80	14,0	16,0	SW17	5	36,00
8275414/7	M14	7,0	15	435	315	22	70	15,0	14,2	SW19	1	40,00
8275416/8	M16	8,0	16	500	360	26	80	17,0	16,0	SW22	1	70,30
8275416/10	M16	10,0	16	510	370	26	90	17,0	17,8	SW22	1	73,00
8275420/10	M20	10,0	19	560	410	30	90	20,0	17,8	SW27	1	97,70
8275420/12	M20	12,0	19	560	410	30	105	20,0	20,0	SW27	1	106,00

NEW

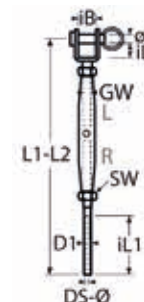

Einzelteile Art.: 8418, 8307, 8432

Seperate parts art.: 8418, 8307, 8432

Pièces individuelles art.: 8418, 8307, 8432

Wantenspanner, Toggle-Terminal / A4-AISI 316

Turnbuckle toggle-terminal / Ridoir chape articulée à sertir

8276

Artikel-Nr. Item-no.	GW	DS-Ø WR-Ø	ø	L1	L2	iL	iL1	iB	D1	Antrieb Drive	Box	*€/Stück *€/piece
8276405/2	M5	2,0	5	165	235	13	32	6	5,5	SW7	5	8,00
8276405/25	M5	2,5	5	165	235	13	32	6	5,5	SW7	5	8,00
8276406/3	M6	3,0	6	250	180	15	39	7	6,4	SW8	5	10,70
8276406/4	M6	4,0	6	260	190	15	45	7	7,5	SW8	5	10,90
8276408/4	M8	4,0	8	285	210	20	45	10	7,5	SW10	5	14,40
8276408/5	M8	5,0	8	290	215	20	52	10	9,0	SW10	5	15,00
8276410/5	M10	5,0	9	340	250	25	52	12	9,0	SW13	5	22,50
8276410/6	M10	6,0	9	355	265	25	64	12	12,6	SW13	5	24,00
8276412/6	M12	6,0	12	410	300	30	64	13	12,6	SW17	5	44,70
8276412/8	M12	8,0	12	430	320	30	80	13	16,0	SW17	5	46,00
8276416/8	M16	8,0	16	530	390	40	80	17	16,0	SW22	1	77,00
8276416/10	M16	10,0	16	540	400	40	90	17	17,8	SW22	1	85,00
8276420/10	M20	10,0	19	590	450	45	105	20	17,8	SW27	1	187,00

NEW
NEW



Einzelteile Art.: 8418, 8307, 8503

Seperate parts art.: 8418, 8307, 8503

Pièces individuelles art.: 8418, 8307, 8503

Spannschlösser, Terminals und Drahtseile

Turnbuckles, terminals and wire ropes

Tendeurs, ridoirs, embouts à sertir et câbles

815163

Wantenspanner, Toggle-Toggle / A4-AISI 316

Turnbuckle toggle-toggle / Ridoir articulée à sertir

NEW



Artikel-Nr. Item-no.	GW	ø	L1	L2	iL	iB	**BL kg	Box	*€/Stück *€/piece
815163406	M6	6	245	165	17	8,0	770	10	11,60
815163408	M8	8	293	203	21	10,5	1390	10	15,80
815163410	M10	10	350	240	26	13,5	2180	5	26,20
815163412	M12	12	405	300	31	13,9	3200	5	50,40
815163416	M16	16	530	380	36	18,0	5700	1	91,30
815163420	M20	20	590	440	43	19,7	8900	1	136,00

814065

Wantenspanner, Gabel-Gabel, gedrehte Ausführung / A4-AISI 316

Turnbuckle fork-fork, machined / Ridoir à chapes usinées



NEW

Artikel-Nr. Item-no.	GW	ø	L1	L2	iL	iB	Antrieb Drive	**BL kg	Box	*€/Stück *€/piece
814065404	M4	4	175	115	8	5,5	SW7	380	10	14,70
814065405	M5	5	200	140	10	6,5	SW7	460	10	15,30
814065406	M6	6	230	160	10	7,5	SW8	910	10	16,50
814065408	M8	8	255	180	11	11,0	SW10	1330	10	34,70
814065410	M10	9	310	220	14	12,0	SW13	2180	5	46,70
814065412	M12	12	380	270	20	14,0	SW17	2300	5	71,00
814065414	M14	12	415	295	22	15,0	SW19	2200	1	81,00
814065416	M16	16	480	340	26	17,0	SW22	5310	1	190,00

814066

Wantenspanner, Gabel-Terminal, gedrehte Ausführung / A4-AISI 316

Turnbuckle fork-terminal, machined / Ridoir chape usinée à sertir



NEW

Artikel-Nr. Item-no.	GW	DS-ø WR-ø	ø	L1	L2	iL	iL1	iB	D1	Antrieb Drive	Box	*€/Stück *€/piece
814066405/2	M5	2,0	4	215	155	10	32	6,5	5,5	SW7	10	12,30
814066405/25	M5	2,5	5	215	155	10	32	6,5	5,5	SW7	10	13,00
814066406/3	M6	3,0	6	250	180	10	39	7,5	6,4	SW8	10	15,00
814066406/4	M6	4,0	6	260	190	10	45	7,5	7,5	SW8	10	16,20
814066408/4	M8	4,0	8	285	210	12	45	11,0	7,5	SW10	10	23,00
814066408/5	M8	5,0	8	290	215	12	52	11,0	9,0	SW10	10	24,00
814066410/5	M10	5,0	9	330	240	14	52	12,0	9,0	SW13	5	31,00
814066410/6	M10	6,0	9	345	255	14	64	12,0	12,6	SW13	5	34,00
814066412/6	M12	6,0	12	410	300	21	64	14,0	12,6	SW17	5	45,00
814066412/8	M12	8,0	12	430	320	21	80	14,0	16,0	SW17	5	53,00
814066416/8	M16	8,0	16	510	370	26	80	17,0	16,0	SW22	1	127,00
814066416/10	M16	10,0	16	520	380	26	90	17,0	17,8	SW22	1	130,00

Spannschlösser, Terminals und Drahtseile

Turnbuckles, terminals and wire ropes

Tendeurs, ridoirs, embouts à sertir et câbles

2

NEW

Wantenspanner Terminal-Terminal / A4-AISI 316

Turnbuckle terminal-terminal / Ridoir terminaison-terminaison

815103

Artikel-Nr. Item-no.	GW	DS-Ø WR-Ø	L	L1	iL	D1	Antrieb Drive	Box	*€/Stück *€/piece
815103405/2	M5	2	240	180	32	5,5	SW7	10	6,90
815103405/25	M5	2,5	240	180	32	5,5	SW7	10	7,40
815103406/3	M6	3	275	205	39	6,4	SW8	10	8,60
815103406/4	M6	4	300	230	45	7,5	SW8	10	8,80
815103408/4	M8	4	310	235	45	7,5	SW10	10	12,40
815103408/5	M8	5	325	250	52	9,0	SW10	10	12,70
815103410/5	M10	5	360	270	52	9,0	SW13	5	18,70
815103410/6	M10	6	390	300	64	12,6	SW13	5	23,10
815103412/6	M12	6	445	330	64	12,6	SW17	5	33,60
815103412/8	M12	8	480	365	80	16,0	SW17	5	44,10
815103416/8	M16	8	550	410	80	16,0	SW22	1	67,80



2

Gabel mit Rechtsgewinde / A4-AISI 316

Fork with right thread / Chape avec filetage à droite

8386

Artikel-Nr. Item-no.	GW	ø	L1	L2	iL	iB	H	Antrieb Drive	Box	*€/Stück *€/piece
8386404	M4	4	52	36	8	6,5	12	SW7	10	2,00
8386405	M5	5	65	42	10	6,5	13	SW8	10	2,30
8386406	M6	6	72	48	10	7,5	15	SW10	10	2,90
8386408	M8	8	81	56	11	11,0	19	SW13	10	3,90
8386410	M10	9	96	63	14	12,0	21	SW17	5	6,30
8386412	M12	12	122	80	20	14,0	27	SW19	5	14,20
8386414	M14	12	127	89	22	15,0	27	SW22	1	14,50
8386416	M16	16	158	103	26	17,0	38	SW24	1	26,50

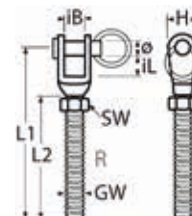

Gabel mit Linksgewinde / A4-AISI 316

Fork with left thread / Chape avec filetage à gauche

8432

Artikel-Nr. Item-no.	GW	ø	L1	L2	iL	iB	H	Antrieb Drive	Box	*€/Stück *€/piece
8432404	M4L	4	52	36	8	6,5	12	SW7	10	2,20
8432405	M5L	5	65	42	10	6,5	13	SW8	10	2,60
8432406	M6L	6	72	48	10	7,5	15	SW10	10	3,20
8432408	M8L	8	81	56	11	11,0	19	SW13	10	4,90
8432410	M10L	9	96	63	14	12,0	21	SW17	5	6,90
8432412	M12L	12	122	80	20	14,0	27	SW19	5	14,70
8432414	M14L	12	127	89	22	15,0	27	SW22	1	16,20
8432416	M16L	16	158	103	26	17,0	38	SW24	1	27,00

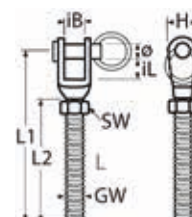

2

Spannschlösser, Terminals und Drahtseile

Turnbuckles, terminals and wire ropes

Tendeurs, ridoirs, embouts à sertir et câbles

814552

Gabel mit Rechtsgewinde, gedrehte Ausführung, MT-Serie / A4-AISI 316
Fork with right thread, machined, MT-series / Ridoir avec filetage à droite, usinée, MT-séries



NEW

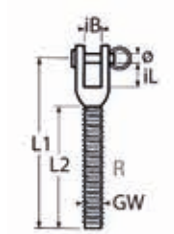

Artikel-Nr. Item-no.	GW	ø	L1	L2	iL	iB	Box	*€/Stück *€/piece
814552404	M4	4	55	35	8	5,5	10	5,90
814552405	M5	5	70	42	10	6,5	10	7,70
814552406	M6	6	78	48	10	7,5	10	10,30
814552408	M8	8	90	56	11	11	5	17,30
814552410	M10	9	104	63	14	12	5	22,80

814551

Gabel mit Linksgewinde, gedrehte Ausführung, MT-Serie / A4-AISI 316
Fork with left thread, machined, MT-series / Ridoir avec filetage à gauche, usinée, MT-séries



NEW

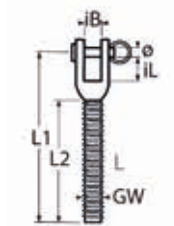

Artikel-Nr. Item-no.	GW	ø	L1	L2	iL	iB	Box	*€/Stück *€/piece
814551404	M4L	4	55	35	8	5,5	10	5,90
814551405	M5L	5	70	42	10	6,5	10	7,70
814551406	M6L	6	78	48	10	7,5	10	10,30
814551408	M8L	8	90	56	11	11	5	17,30
814551410	M10L	9	104	63	14	12	5	22,80

815120

Gabel mit Holzgewinde, MT-Serie / A4-AISI 316
Fork with wood thread, MT-series / Chape avec filetage bois, MT-séries



NEW

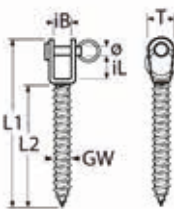

Artikel-Nr. Item-no.	GW	ø	L1	L2	iL	iB	T	Box	*€/Stück *€/piece
815120404	4	4	56	40	8	5,5	12	10	3,30
815120405	5	5	69	50	10	6,5	13	10	3,60
815120406	6	6	81	60	10	7,5	14	10	4,90
815120408	8	8	105	80	11	11	18,5	10	6,50
815120410	10	9	108	80	14	12	21	5	8,90

Spannschlösser, Terminals und Drahtseile

Turnbuckles, terminals and wire ropes
Tendeurs, ridoirs, embouts à sertir et câbles

2



Gabel mit Holzgewinde, gedrehte Ausführung, MT-Serie / A4-AISI 316 Fork with wood thread, machined, MT-series / Ridoir avec filetage bois, usinée, MT-séries

814553

NEW

Artikel-Nr. Item-no.	GW	ø	L1	L2	iL	iB	Box	*€/Stück *€/piece
814553404	4	4	60	40	8	5,5	10	6,50
814553405	5	5	78	50	10	6,5	10	8,50
814553406	6	6	90	60	10	7,5	10	11,30
814553408	8	8	114	80	11	11	5	18,50
814553410	10	9	121	80	14	12	5	24,40

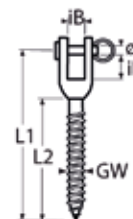

2

Mini-Gabel mit Rechtsgewinde / A4-AISI 316 Mini-fork with right thread / Mini-chape avec filetage à droite

8452

Artikel-Nr. Item-no.	GW	ø	L1	L2	iL	iB	Box	*€/Stück *€/piece
8452404	M4	4	37	20	8	5,5	10	2,50
8452405	M5	5	40	20	10	8,0	10	2,70
8452406	M6	6	47	25	10	9,0	10	2,80
8452408	M8	8	52	25	12	10,0	5	3,20
8452410	M10	10	72	45	14	12,0	5	5,40

NEW

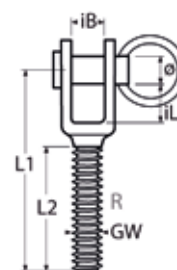

Mini-Gabel mit Linksgewinde / A4-AISI 316 Mini-fork with left thread / Mini-chape avec filetage à gauche

8453

Artikel-Nr. Item-no.	GW	ø	L1	L2	iL	iB	Box	*€/Stück *€/piece
8453404	M4L	4	37	20	8	5,5	10	2,50
8453405	M5L	5	40	20	10	8,0	10	2,70
8453406	M6L	6	47	25	10	9,0	10	2,80
8453408	M8L	8	52	25	12	10,0	5	3,20
8453410	M10L	10	72	45	14	12,0	5	5,40

NEW

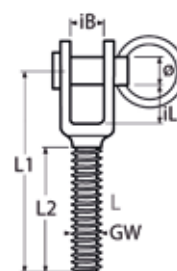

Mini-Gabel mit Innengewinde, rechts / A4-AISI 316 Mini-fork with internal right thread / Mini-chape avec filetage interne à droite

8455

Artikel-Nr. Item-no.	GW	ø	L1	iL1	iL	iB	D1	Box	*€/Stück *€/piece
8455405	M5	5	55	27	10	8	7,5	10	7,00
8455406	M6	6	60	30	10	9	8,0	10	8,00
8455408	M8	8	65	31	12	10	12,0	5	9,00
8455410	M10	10	75	40	12	12	14,0	5	10,00

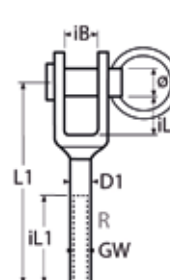

2

Spannschlösser, Terminals und Drahtseile

Turnbuckles, terminals and wire ropes

Tendeurs, ridoirs, embouts à sertir et câbles

8456

Mini-Gabel mit Innengewinde, links / A4-AISI 316

Mini-fork with internal left thread / Mini-chape avec filetage interne à gauche

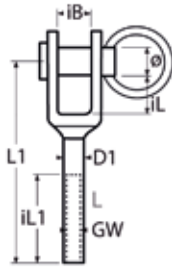

Artikel-Nr. Item-no.	GW	ø	L1	iL1	iL	iB	D1	Box	*€/Stück *€/piece
8456405	M5L	5	55	27	10	8	7,5	10	7,00
8456406	M6L	6	60	30	10	9	8,0	10	8,00
8456408	M8L	8	65	31	12	10	12,0	5	9,00
8456410	M10L	10	75	40	12	12	14,0	5	10,00

8418

Spannschlossmutter ähnlich DIN 1478 / A4-AISI 316

Turnbuckle body similar to DIN 1478 / Corps de ridoir similaire DIN 1478

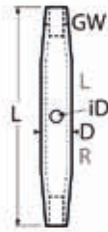

Artikel-Nr. Item-no.	GW	L	D	iD	Box	*€/Stück *€/piece
8418404	M4	70	7,0	2,5	10	1,80
8418405	M5	80	8,0	2,5	10	2,10
8418406	M6	95	10,0	3,2	10	2,50
8418408	M8	105	13,0	4,2	10	4,00
8418410	M10	125	17,0	5,0	5	6,80
8418412	M12	150	21,0	6,0	5	12,00
8418414	M14	165	21,0	7,0	1	14,60
8418416	M16	190	26,5	8,0	1	19,40
8418420	M20	210	33,5	9,0	1	34,20

8457

Mini-Spannschlossmutter / A4-AISI 316

Mini turnbuckle body / Mini corps de ridoir

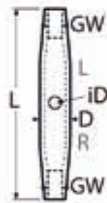

NEW

Artikel-Nr. Item-no.	GW	L	D	iD	Box	*€/Stück *€/piece
8457404	M4	40	7	2,5	10	1,70
8457405	M5	55	8	2,5	10	2,30
8457406	M6	65	10	3,2	10	2,50
8457408	M8	70	13	4,2	5	3,60
8457410	M10	85	17	5,0	5	6,80

8468

Kontermutter für Wantenspanner / A4-AISI 316

Counter nut for turnbuckle / Ecrou pour ridoir

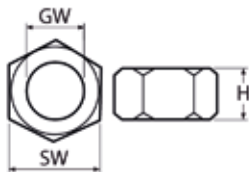
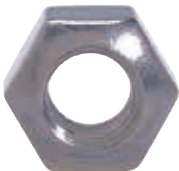

Artikel-Nr. R Item-no. R	Artikel-Nr. L Item-no. L	GW	H	Antrieb Drive	Box	*€/Stück *€/piece
84684R04	84684L04	M4/M4L	3,2	SW7	10	0,20
84684R05	84684L05	M5/M5L	3,2	SW7	10	0,25
84684R06	84684L06	M6/M6L	4,0	SW8	10	0,30
84684R08	84684L08	M8/M8L	5,0	SW10	10	0,60
84684R10	84684L10	M10/M10L	6,5	SW13	10	0,75
84684R12	84684L12	M12/M12L	8,0	SW17	10	1,10
84684R14	84684L14	M14/M14L	10,0	SW19	5	1,50
84684R16	84684L16	M16/M16L	11,0	SW22	5	2,80
84684R20	84684L20	M20/M20L	15,0	SW27	5	4,10

Spannschlösser, Terminals und Drahtseile

Turnbuckles, terminals and wire ropes

Tendeurs, ridoirs, embouts à sertir et câbles

2

Spannschloss / A4-AISI 316
Turnbuckle / Tendeur

8246

Artikel-Nr. Item-no.	GW	ø	L	L1	iD	C	**BL kg Typ A	Box	*€/Stück *€/piece
82464*A*B*C03	M3	2,7	130	90	5	5	50	10	2,30
82464*A*B*C04	M4	3,5	135	95	6	6	300	10	2,40
82464*A*B*C05	M5	4,4	165	110	8	7,5	550	10	3,50
82464*A*B*C06	M6	5,3	210	145	10	9	750	10	4,20
82464*A*B*C08	M8	7,1	280	190	14	12	1300	10	5,80
82464*A*B*C10	M10	8,9	345	240	16	13	2000	5	9,70
82464*A*B*C12	M12	10,8	455	300	18	14	2800	5	19,30
82464*A*B*C16	M16	14,4	580	390	26	18	5200	1	41,20
82464*A*B*C20	M20	18,0	680	460	30	20	8000	1	73,50
82464*A*B*C22	M22	22,0	970	690	30	28	5630	1	116,00
82464*A*B*C24	M24	25,0	1110	780	34	32	6590	1	184,00



NEW

NEW

*A = Auge-Auge. Einzelteile Art.: 8417, 8433, 8434

*B = Haken-Haken. Einzelteile Art.: 8417, 8435, 8436

*C = Auge (Rechts)-Haken (Links). Einzelteile Art.:

8417, 8433, 8436

*A = Eye-Eye. Seperate parts art.: 8417, 8433, 8434

*B = Hook-Hook. Seperate parts art.: 8417, 8435, 8436

*C = Eye (Right)-Hook (Left). Seperate parts art.: 8417, 8433, 8436

*A = Oeil-Oeil. Pièces individuelles art.: 8417, 8433, 8434

*B = Crochet-Crochet. Pièces individuelles art.: 8417, 8435, 8436

*C = Oeil (pas à droite)-Crochet (pas à gauche). Pièces individuelles art.: 8417, 8433, 8436

Bruchlastangaben BL Kg nur für Typ A! / Breaking loads BL Kg only for type A! / Charges de rupture BL Kg seulement pour le type A!



Spannschloss Duplex, MT-Serie / D6-AISI 316 LN
Duplex turnbuckle, MT-series / Tendeur en Duplex, MT-séries

815060

NEW

Artikel-Nr. Item-no.	GW	ø	L	L1	iD	C	**BL kg Typ A	Box	*€/Stück *€/piece
8150604462*A*B*C05	M5	4,3	165	110	8	7,5	160	5	6,20
8150604462*A*B*C06	M6	5,3	210	145	10	9	320	5	8,30
8150604462*A*B*C08	M8	7,0	280	190	14	12	560	5	13,80
8150604462*A*B*C10	M10	8,9	345	240	16	13	880	2	22,40
8150604462*A*B*C12	M12	10,9	455	300	18	14	1200	2	39,40
8150604462*A*B*C16	M16	14,5	580	390	26	18	2400	1	78,40

*A = Auge-Auge.

Einzelteile Art.: 815109, 815107, 815108

*B = Haken-Haken.

Einzelteile Art.: 815109, 815105, 815106

*C = Auge (Rechts)-Haken (Links).

Einzelteile Art.: 815109, 815107, 815106

*A = Eye-Eye. Seperate parts art.: 815109, 815107, 815108

*B = Hook-Hook. Seperate parts art.: 815109, 815105, 815106

*C = Eye (Right)-Hook (Left). Seperate parts art.: 815109, 815107, 815106

*A = Oeil-Oeil. Pièces individuelles art.: 815109, 815107, 815108

*B = Crochet-Crochet. Pièces individuelles art.: 815109, 815105, 815106

*C = Oeil (pas à droite)-Crochet (pas à gauche).

Pièces individuelles art.: 815109, 815107, 815106



A

B

C

Bruchlastangaben BL Kg nur für Typ A! / Breaking loads BL Kg only for type A! / Charges de rupture BL Kg seulement pour le type A!

2

Spannschlösser, Terminals und Drahtseile

Turnbuckles, terminals and wire ropes

Tendeurs, ridoirs, embouts à sertir et câbles

814932

Spannschloss, Haken-Haken mit Sicherung / A4-AISI 316

Turnbuckle hook-hook with spring snap / Tendeur crochet-crochet avec barrettes de sécurité



Artikel-Nr. Item-no.	GW	L	L1	C	Antrieb Drive	Box	*€/Stück *€/piece
814932406	M6	235	175	10	SW10	5	6,90
814932408	M8	300	210	11	SW13	5	10,00
814932412	M12	505	340	16	SW19	5	36,00

8339

Wantenspanner, offen, Gabel-Gabel / A4-AISI 316

Turnbuckle open body fork-fork / Tendeur à chapes

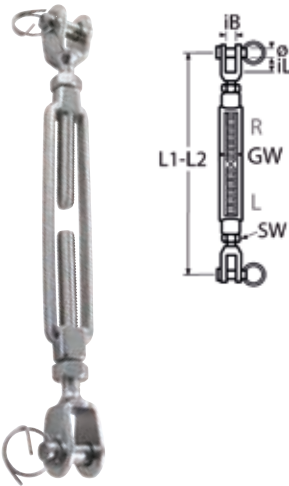

NEW

Artikel-Nr. Item-no.	GW	ø	L1	L2	iL	iB	Antrieb Drive	**BL kg	Box	*€/Stück *€/piece
8339404	M4	4	95	135	8	6,5	SW7	340	10	7,00
8339405	M5	5	165	120	10	6,5	SW8	500	10	8,00
8339406	M6	6	205	140	10	7,5	SW10	600	10	9,00
8339408	M8	8	270	180	11	11,0	SW13	1100	10	13,80
8339410	M10	9	330	220	19	12,0	SW17	1750	5	21,40
8339412	M12	12	460	300	20	14,0	SW19	3200	5	36,90
8339414	M14	12	500	325	22	15,0	SW22	3600	1	47,70
8339416	M16	16	570	375	25	17,0	SW24	6800	1	83,50
8339420	M20	19	680	450	31	20,0	SW30	8200	1	117,00

Einzelteile Art.: 8417, 8386, 8432

Seperate parts art.: 8417, 8386, 8432

Pièces individuelles art.: 8417, 8386, 8432

8435

Hakenschraube mit Rechtsgewinde / A4-AISI 316

Hook screw with right thread / Crochet vis avec filetage à droite



Artikel-Nr. Item-no.	GW	L	L1	C	Box	*€/Stück *€/piece
8435403	M3	45	27	5,0	10	0,60
8435404	M4	46	27	6,0	10	0,70
8435405	M5	56	32	7,5	10	0,80
8435406	M6	70	42	9,0	10	0,90
8435408	M8	92	55	12,0	10	1,50
8435410	M10	113	70	13,0	5	2,40
8435412	M12	145	93	14,0	5	4,10
8435416	M16	189	115	18,0	1	11,20
8435420	M20	220	140	20,0	1	22,00
NEW 8435422	M22	215	140	28,0	1	35,80
NEW 8435424	M24	250	165	32,0	1	46,80

Spannschlösser, Terminals und Drahtseile

Turnbuckles, terminals and wire ropes
Tendeurs, ridoirs, embouts à sertir et câbles

2

Hakenschraube mit Linksgewinde / A4-AISI 316 Hook screw with left thread / Crochet vis avec filetage à gauche

8436

Artikel-Nr. Item-no.	GW	L	L1	C	Box	*€/Stück *€/piece
8436403	M3L	45	27	5,0	10	0,60
8436404	M4L	46	27	6,0	10	0,70
8436405	M5L	56	32	7,5	10	0,80
8436406	M6L	70	42	9,0	10	0,90
8436408	M8L	92	55	12,0	10	1,50
8436410	M10L	113	70	13,0	5	2,40
8436412	M12L	145	93	14,0	5	4,10
8436416	M16L	189	115	18,0	1	11,20
8436420	M20L	220	140	20,0	1	22,00
8436422	M22L	215	140	28,0	1	35,80
8436424	M24L	250	165	32,0	1	46,80

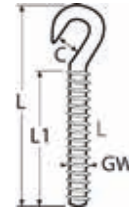

NEW
NEW



Hakenschraube Duplex mit Rechtsgewinde, MT-Serie / D6-AISI 318 LN Duplex hook screw with right thread, MT-series / Crochet vis avec file à droite Duplex, MT-séries

815105

Artikel-Nr. Item-no.	GW	L	L1	C	Box	*€/Stück *€/piece
815105446205	M5	56	32	7,5	5	1,30
815105446206	M6	70	42	9,0	5	1,80
815105446208	M8	92	55	12,0	5	3,10
815105446210	M10	113	70	13,0	2	5,90
815105446212	M12	145	93	14,0	2	9,50
815105446216	M16	189	115	18,0	1	22,60

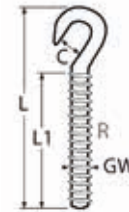

NEW



Hakenschraube Duplex mit Linksgewinde, MT-Serie / D6-AISI 318 LN Duplex hook screw with left thread, MT-series / Crochet vis avec file à gauche Duplex, MT-séries

815106

Artikel-Nr. Item-no.	GW	L	L1	C	Box	*€/Stück *€/piece
815106446205	M5L	56	32	7,5	5	1,30
815106446206	M6L	70	42	9,0	5	1,80
815106446208	M8L	92	55	12,0	5	3,10
815106446210	M10L	113	70	13,0	2	5,90
815106446212	M12L	145	93	14,0	2	9,50
815106446216	M16L	189	115	18,0	1	22,60

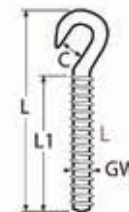

NEW

8433

Augschraube mit Rechtsgewinde / A4-AISI 316

Eye screw with right thread / Vis à œil avec filetage à droite

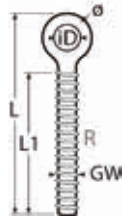

Artikel-Nr. Item-no.	GW	L	L1	iD	ø	Box	*€/Stück *€/piece
8433403	M3	45	27	5	2,7	10	0,60
8433404	M4	46	27	6	3,5	10	0,70
8433405	M5	56	32	8	4,4	10	0,80
8433406	M6	70	42	10	5,3	10	0,90
8433408	M8	92	55	14	7,1	10	1,50
8433410	M10	113	70	16	8,9	5	2,50
8433412	M12	145	93	18	10,8	5	4,20
8433416	M16	189	115	26	14,4	1	11,50
8433420	M20	220	140	30	18,0	1	15,00
NEW 8433422	M22	215	140	30	20,0	1	35,80
NEW 8433424	M24	250	165	34	22,0	1	46,80

8434

Augschraube mit Linksgewinde / A4-AISI 316

Eye screw with left thread / Vis à œil avec filetage à gauche

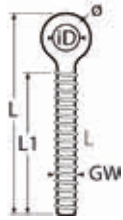

Artikel-Nr. Item-no.	GW	L	L1	iD	ø	Box	*€/Stück *€/piece
8434403	M3L	45	27	5	2,7	10	0,60
8434404	M4L	46	27	6	3,5	10	0,70
8434405	M5L	56	32	8	4,4	10	0,80
8434406	M6L	70	42	10	5,3	10	0,90
8434408	M8L	92	55	14	7,1	10	1,50
8434410	M10L	113	70	16	8,9	5	2,50
8434412	M12L	145	93	18	10,8	5	4,20
8434416	M16L	189	115	26	14,4	1	11,50
8434420	M20L	220	140	30	18,0	1	15,00
NEW 8434422	M22L	215	140	30	20,0	1	35,80
NEW 8434424	M24L	250	165	34	22,0	1	46,80

815107

Augschraube Duplex mit Rechtsgewinde, MT-Serie / D6-AISI 318 LN

Duplex eye screw with right thread, MT-series / Vis à œil avec filet à droite en Duplex, MT-séries

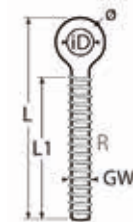
**NEW**

Artikel-Nr. Item-no.	GW	ø	L	L1	iD	Box	*€/Stück *€/piece
815107446205	M5	4,3	56	32	8	5	1,10
815107446206	M6	5,3	70	42	10	5	1,70
815107446208	M8	7,0	92	55	14	5	3,10
815107446210	M10	8,9	113	70	16	2	5,90
815107446212	M12	10,9	145	93	18	2	9,50
815107446216	M16	14,5	189	115	26	1	22,60

Spannschlösser, Terminals und Drahtseile

Turnbuckles, terminals and wire ropes
Tendeurs, ridoirs, embouts à sertir et câbles

2



Augschraube Duplex mit Linksgewinde, MT-Serie / D6-AISI 318 LN Duplex eye screw with left thread, MT-series / Vis à œil avec filet à gauche en Duplex, MT-séries

815108

NEW

Artikel-Nr. Item-no.	GW	ø	L	L1	iD	Box	*€/Stück *€/piece
815108446205	M5L	4,3	56	32	8	5	1,10
815108446206	M6L	5,3	70	42	10	5	1,70
815108446208	M8L	7,0	92	55	14	5	3,10
815108446210	M10L	8,9	113	70	16	2	5,90
815108446212	M12L	10,9	145	93	18	2	9,50
815108446216	M16L	14,5	189	115	26	1	22,60

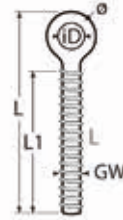

2



Spannschlossmutter Duplex ähnl. DIN 1480, MT-Serie / D6-AISI 318 LN Duplex turnbuckle body sim. to DIN 1480, MT-series / Corps de tendeur en Duplex, MT-séries

815109

NEW

Artikel-Nr. Item-no.	GW	L	Box	*€/Stück *€/piece
815109446205	M5	70	5	3,90
815109446206	M6	90	5	4,70
815109446208	M8	120	5	7,50
815109446210	M10	150	2	10,50
815109446212	M12	200	2	20,60
815109446216	M16	250	1	36,40



Spannschlossmutter ähnlich DIN 1480 / A4-AISI 316 Open turnbuckle body similar to DIN 1480 / Corps de tendeur

8417

Artikel-Nr. Item-no.	GW	L	Box	*€/Stück *€/piece
8417403	M3	60	10	1,50
8417404	M4	58	10	1,60
8417405	M5	70	10	1,80
8417406	M6	90	10	2,10
8417408	M8	120	10	4,20
8417410	M10	150	5	7,20
8417412	M12	200	5	13,60
8417416	M16	250	1	25,50
8417420	M20	300	1	46,70
8417422	M22	300	1	52,50
8417424	M24	350	1	78,00



NEW
NEW

2

Spannschlösser, Terminals und Drahtseile

Turnbuckles, terminals and wire ropes

Tendeurs, ridoirs, embouts à sertir et câbles

8307

Terminal mit Rechtsgewinde / A4-AISI 316

Terminal with right thread / Terminaison avec filetage à droite

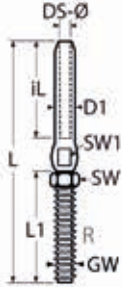

NEW

Artikel-Nr. Item-no.	GW	DS-Ø WR-Ø	L	L1	iL	D1	Antrieb Drive	Antrieb 2 Drive 2	Box	*€/Stück *€/piece
8307404/2	M4	2,0	73	38	24	4,8	SW7	SW3	10	2,00
8307405/2	M5	2,0	86	40	32	5,5	SW8	SW4	10	2,10
8307405/25	M5	2,5	86	40	32	5,5	SW8	SW4	10	2,10
8307406/3	M6	3,0	100	48	39	6,4	SW10	SW5	10	2,40
8307406/4	M6	4,0	110	48	45	7,5	SW10	SW6	10	3,50
8307408/4	M8	4,0	117	57	45	7,5	SW13	SW6	10	3,60
8307408/5	M8	5,0	124	57	52	9,0	SW13	SW7	10	4,70
8307410/5	M10	5,0	130	63	52	9,0	SW17	SW7	5	5,00
8307410/6	M10	6,0	145	63	64	12,6	SW17	SW10	5	8,70
8307412/6	M12	6,0	162	80	64	12,6	SW19	SW10	5	9,50
8307412/8	M12	8,0	180	80	80	16,0	SW19	SW14	5	16,80
8307414/7	M14	7,0	180	90	70	14,2	SW22	SW12	1	18,00
8307416/8	M16	8,0	200	100	80	16,0	SW24	SW14	1	19,50
8307416/10	M16	10,0	210	100	90	17,8	SW24	SW15	1	23,50
8307420/10	M20	10,0	230	119	90	17,8	SW30	SW15	1	28,50
8307420/12	M20	12,0	245	120	105	20,0	SW30	SW17	1	39,20
8307422/14	M22	14,0	308	140	140	25,0	SW32	SW22	1	55,00
8307424/16	M24	16,0	363	170	160	28,0	SW36	SW24	1	90,50

8467

Terminal mit Linksgewinde / A4-AISI 316

Terminal with left thread / Terminaison avec filetage à gauche

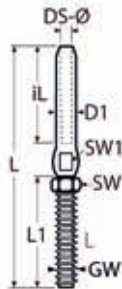

NEW

Artikel-Nr. Item-no.	GW	DS-Ø WR-Ø	L	L1	iL	D1	Antrieb Drive	Antrieb 2 Drive 2	Box	*€/Stück *€/piece
8467404/2	M4L	2,0	73	38	24	4,8	SW7	SW3	10	2,10
8467405/2	M5L	2,0	86	40	32	5,5	SW8	SW4	10	2,20
8467405/25	M5L	2,5	86	40	32	5,5	SW8	SW4	10	2,20
8467406/3	M6L	3,0	100	48	39	6,4	SW10	SW5	10	2,60
8467406/4	M6L	4,0	110	48	45	7,5	SW10	SW6	10	3,70
8467408/4	M8L	4,0	117	57	45	7,5	SW13	SW6	10	3,80
8467408/5	M8L	5,0	124	57	52	9,0	SW13	SW7	10	4,80
8467410/5	M10L	5,0	130	63	52	9,0	SW17	SW7	5	5,20
8467410/6	M10L	6,0	145	63	64	12,6	SW17	SW10	5	8,90
8467412/6	M12L	6,0	162	80	64	12,6	SW19	SW10	5	9,90
8467412/8	M12L	8,0	180	80	80	16,0	SW19	SW14	5	17,10
8467414/7	M14L	7,0	180	90	70	14,2	SW22	SW12	1	18,50
8467416/8	M16L	8,0	200	100	80	16,0	SW24	SW14	1	19,90
8467416/10	M16L	10,0	210	100	90	17,8	SW24	SW15	1	23,90
8467420/10	M20L	10,0	230	119	90	17,8	SW30	SW15	1	29,90
8467420/12	M20L	12,0	245	120	105	20,0	SW30	SW17	1	39,90

Spannschlösser, Terminals und Drahtseile

Turnbuckles, terminals and wire ropes

Tendeurs, ridoirs, embouts à sertir et câbles

2

Mini-Terminal mit Rechtsgewinde / A4-AISI 316

Mini-terminal with right thread / Mini-terminaison avec filetage à droite

8445

Artikel-Nr. Item-no.	GW	DS-Ø WR-Ø	L	L1	iL	D1	Box	*€/Stück *€/piece
8445405/2	M5	2	50	27	18	5,5	10	2,10
8445405/25	M5	2,5	50	27	18	5,5	10	2,40
8445405/3	M5	3	50	27	18	6,4	10	2,50
8445406/4	M6	4	60	30	26	7,5	10	2,70
8445408/5	M8	5	70	31	32	9,0	5	3,00
8445410/6	M10	6	85	40	38	12,6	5	4,00

NEW

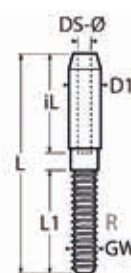

Mini-Terminal mit Linksgewinde / A4-AISI 316

Mini-terminal with left thread / Mini-terminaison avec filetage à gauche

8446

Artikel-Nr. Item-no.	GW	DS-Ø WR-Ø	L	L1	iL	D1	Box	*€/Stück *€/piece
8446405/2	M5L	2	50	27	18	5,5	10	2,20
8446405/25	M5L	2,5	50	27	18	5,5	10	2,50
8446405/3	M5L	3	50	27	18	6,4	10	2,60
8446406/4	M6L	4	60	30	26	7,5	10	3,00
8446408/5	M8L	5	70	31	32	9,0	5	3,30
8446410/6	M10L	6	85	40	38	12,6	5	4,30

NEW

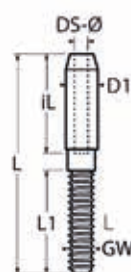

Mini-Terminal mit Rechtsgewinde, lang / A4-AISI 316

Mini-terminal with right thread, long / Mini-terminaison avec filetage long à droite

814866

Artikel-Nr. Item-no.	GW	DS-Ø WR-Ø	L	L1	iL	D1	Box	*€/Stück *€/piece
814866405/2	M5	2	73	50	18	5,5	10	2,20
814866405/25	M5	2,5	73	50	18	5,5	10	2,50
814866405/3	M5	3	73	50	18	6,4	10	2,80
814866406/4	M6	4	89	60	26	7,5	10	3,10
814866408/5	M8	5	98	60	32	9,0	5	3,60
814866410/6	M10	6	124	80	38	12,6	5	5,60

NEW

NEW

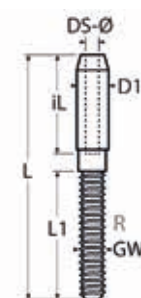

Mini-Terminal mit Linksgewinde, lang / A4-AISI 316

Mini-terminal with left thread, long / Mini-terminaison avec filetage long à gauche

814867

Artikel-Nr. Item-no.	GW	DS-Ø WR-Ø	L	L1	iL	D1	Box	*€/Stück *€/piece
814867405/2	M5L	2	73	50	18	5,5	10	2,50
814867405/25	M5L	2,5	73	50	18	5,5	10	2,80
814867405/3	M5L	3	73	50	18	6,4	10	3,10
814867406/4	M6L	4	89	60	26	7,5	10	3,40
814867408/5	M8L	5	98	60	32	9,0	5	3,90
814867410/6	M10L	6	124	80	38	12,6	5	5,90

NEW

NEW

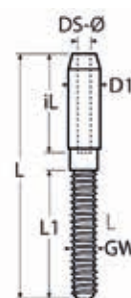

2

Spannschlösser, Terminals und Drahtseile

Turnbuckles, terminals and wire ropes

Tendeurs, ridoirs, embouts à sertir et câbles

8449

Mini-Terminal mit Innengewinde, rechts / A4-AISI 316

Mini-terminal with internal right thread / Mini-terminaison avec filetage interne à droite

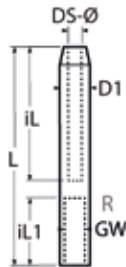

	Artikel-Nr. Item-no.	GW	DS-Ø WR-Ø	L	iL	iL1	D1	Box	*€/Stück *€/piece
NEW	8449404/2	M4	2,0	45	21	20	5,5	10	2,00
NEW	8449405/25	M5	2,5	50	26	20	5,5	10	2,50
	8449405/3	M5	3,0	55	28	20	6,4	10	3,00
	8449406/4	M6	4,0	65	36	22	7,5	10	4,00
	8449406/5	M6	5,0	70	41	22	9,0	5	4,50
	8449408/6	M8	6,0	85	53	25	12,6	5	6,70

8450

Mini-Terminal mit Innengewinde, links / A4-AISI 316

Mini-terminal with internal left thread / Mini-terminaison avec filetage interne à gauche

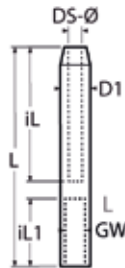

	Artikel-Nr. Item-no.	GW	DS-Ø WR-Ø	L	iL	iL1	D1	Box	*€/Stück *€/piece
NEW	8450404/2	M4L	2,0	45	21	20	5,5	10	2,30
NEW	8450405/25	M5L	2,5	50	26	20	5,5	10	2,80
	8450405/3	M5L	3,0	55	28	20	6,4	10	3,30
	8450406/4	M6L	4,0	65	36	22	7,5	10	4,30
	8450406/5	M6L	5,0	70	41	22	9,0	5	4,80
	8450408/6	M8L	6,0	85	53	25	12,6	5	7,00

815121

Unterlegscheibe mit Innengewinde, MT-Serie / A4-AISI 316

Washer with inside thread, MT-series / Rondelle avec filetage intérieur, MT-séries



NEW

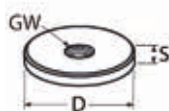

	Artikel-Nr. Item-no.	GW	D	S	Box	*€/Stück *€/piece
	815121404	M4	25	3,0	20	2,80
	815121405	M5	30	3,5	20	3,60
	815121406	M6	30	4,0	20	3,70
	815121408	M8	35	4,5	10	4,90
	815121410	M10	40	5,0	10	6,40

8466

Gewindestück, rechts und links / A4-AISI 316

Stud bolt, right and left thread / Terminaison avec filetage à droite et à gauche

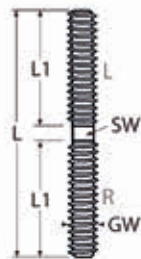

	Artikel-Nr. Item-no.	GW	L	L1	Antrieb Drive	Box	*€/Stück *€/piece
NEW	8466404	M4	45	20	SW2,5	10	0,90
	8466405	M5	65	30	SW3	10	1,00
	8466406	M6	65	30	SW4	10	1,10
	8466408	M8	65	30	SW6	5	1,60
	8466410	M10	85	40	SW7	5	4,90
	8466412	M12	105	50	SW8	5	4,60

Spannschlösser, Terminals und Drahtseile

Turnbuckles, terminals and wire ropes

Tendeurs, ridoirs, embouts à sertir et câbles

2

Mini-Senkkopfterminal / A4-AISI 316

Mini-cone terminal / Mini-terminaison à tête plate à sertir

8459

Artikel-Nr. Item-no.	DS-Ø WR-Ø	L	L1	iL	D	D1	Box	*€/Stück *€/piece
845942	2,0	27	2	20	8,5	5,5	10	1,60
8459425	2,5	30	2	23	8,5	5,5	10	1,60
845943	3,0	34	2	27	8,0	6,4	10	1,70
845944	4,0	43	2	35	9,5	7,5	10	2,10
845945	5,0	50	3	40	13,0	9,0	5	2,90
845946	6,0	64	3	50	16,5	12,6	5	4,80

NEW
NEW

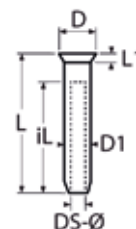

2

Mini-Linsenkopfterminal, dünnwandig / A4-AISI 316

Mini-dome head terminal, thin walled / Mini-terminaison à tête cylindrique bombée à sertir

8448

Artikel-Nr. Item-no.	DS-Ø WR-Ø	L	L1	iL	D	D1	Box	*€/Stück *€/piece
844842	2,0	25	2	18	8	4,8	10	1,50
844842/5	2,5	25	2	18	8	4,8	10	1,50
844843	3,0	25	2,0	18	9	5,5	10	2,50
844844	4,0	30	2,0	24	11	6,4	10	3,00
844845	5,0	35	2,5	28	13	7,5	5	3,50
844846	6,0	40	3,0	32	16	9,0	5	4,00

NEW
NEW

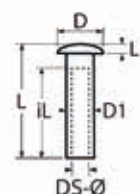

Terminal muß mit einer Press- oder Walzbackengröße kleiner verarbeitet werden. Siehe Maßangabe D1.

Terminals must be pressed or swaged with jaws one size smaller. See dimension D1.

Le terminal doit être traité avec une mâchoire de presse ou de rouleau de plus petite taille. Voir dimension D1.

Linsenkopfhülse mit Innengewinde / A4-AISI 316

Dome case nut with internal thread / Tête bombée avec filetage interne

8464

Artikel-Nr. Item-no.	GW	L	L1	iL	D	D1	Antrieb Drive	Box	*€/Stück *€/piece
8464404	M4	22	3	17	10	6,0	SW4	10	2,50
8464405	M5	25	4	18	12	7,5	SW5	10	3,00
8464406	M6	30	4	24	12	8,0	SW5	10	3,50
8464408	M8	35	5	28	16	12,0	SW6	5	4,00
8464410	M10	40	6	32	20	14,0	SW6	5	5,00

NEW

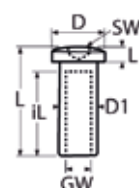

Terminal mit Holzgewinde, rechts / A4-AISI 316

Terminal with right-hand wood thread / Terminaison avec filetage bois à droite

814087

Artikel-Nr. Item-no.	GW	DS-Ø WR-Ø	L	L1	D1	Antrieb Drive	Box	*€/Stück *€/piece
814087403	6	3	97	48	6,4	SW5	10	2,40
814087404	8	4	115	54	7,5	SW6	10	3,20
814087405	10	5	128	61	9,0	SW7	5	5,40
814087406	12	6	162	79	12,6	SW10	5	9,90

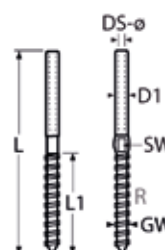

2

Spannschlösser, Terminals und Drahtseile

Turnbuckles, terminals and wire ropes

Tendeurs, ridoirs, embouts à sertir et câbles

814088

Terminal mit Holzgewinde, links / A4-AISI 316

Terminal with left-hand wood thread / Terminaison avec filetage bois à gauche

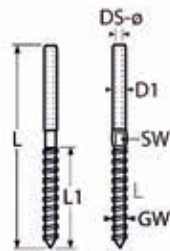

Artikel-Nr. Item-no.	GW	DS-Ø WR-Ø	L	L1	D1	Antrieb Drive	Box	*€/Stück *€/piece
814088403	6	3	97	48	6,4	SW5	10	2,60
814088404	8	4	115	54	7,5	SW6	10	3,50
814088405	10	5	128	61	9,0	SW7	5	5,90
814088406	12	6	162	79	12,6	SW10	5	10,50

8484

Anschweißende mit Rechtsgewinde / A4-AISI 316

Rod end right threaded for welding / Tige à souder avec filetage à droite

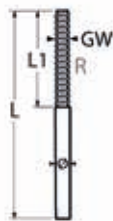

NEW

Artikel-Nr. Item-no.	GW	ø	L	L1	Box	*€/Stück *€/piece
8484404	M4	3,5	55	26	10	0,70
8484405	M5	4,4	85	40	10	1,50
8484406	M6	5,2	100	45	10	1,60
8484408	M8	7,0	112	52	10	1,80
8484410	M10	8,8	127	62	5	2,70
8484412	M12	10,7	140	75	5	4,10
8484414	M14	12,5	150	82	1	11,80
8484416	M16	14,2	170	95	1	12,00
8484420	M20	18,1	185	105	1	14,00

8511

Anschweißende mit Linksgewinde / A4-AISI 316

Rod end left threaded for welding / Tige à souder avec filetage à gauche



NEW

Artikel-Nr. Item-no.	GW	ø	L	L1	Box	*€/Stück *€/piece
8511404	M4L	3,5	55	26	10	0,80
8511405	M5L	4,4	85	40	10	1,60
8511406	M6L	5,2	100	45	10	1,70
8511408	M8L	7,0	112	52	10	2,00
8511410	M10L	8,8	127	62	5	3,00
8511412	M12L	10,7	140	75	5	4,50
8511414	M14L	12,5	150	82	1	12,40
8511416	M16L	14,2	170	95	1	12,60
8511420	M20L	18,1	185	105	1	15,00

Spannschlösser, Terminals und Drahtseile

Turnbuckles, terminals and wire ropes
Tendeurs, ridoirs, embouts à sertir et câbles

2

Stockschraube mit Rechtsgewinde / A4-AISI 316 Hanger bolt with right thread / Goujon avec filetage à droite

8515

Artikel-Nr. Item-no.	GW	L	L1	L2	Antrieb Drive	Box	*€/Stück *€/piece	
8515405 080	M5	80	43	32	SW3	10	1,50	NEW
8515406 060	M6	60	20	37	–	10	0,80	NEW
8515406 070	M6	70	20	47	–	10	0,90	NEW
8515406 080	M6	80	25	52	–	10	1,00	NEW
8515406 090	M6	90	35	52	–	10	1,10	NEW
8515408 060	M8	60	20	37	–	10	1,30	NEW
8515408 070	M8	70	25	37	–	10	1,50	NEW
8515408 080	M8	80	30	37	SW6	10	1,70	NEW
8515408 100	M8	100	40	47	SW6	10	2,10	NEW
8515408 120	M8	120	50	47	SW6	10	2,50	NEW
8515408 130	M8	130	50	47	SW6	10	2,60	NEW
8515410 080	M10	80	20	47	SW8	10	2,60	NEW
8515410 100	M10	100	30	57	SW8	10	3,00	NEW
8515410 120	M10	120	50	57	SW8	10	3,40	NEW
8515410 140	M10	140	50	57	SW8	10	3,80	NEW
8515410 150	M10	150	50	57	SW8	10	3,90	NEW

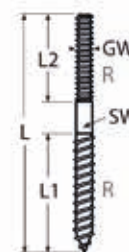

2

Stockschraube mit Linksgewinde / A4-AISI 316 Hanger bolt with left thread / Goujon avec filetage à gauche

8516

Artikel-Nr. Item-no.	GW	L	L1	L2	Antrieb Drive	Box	*€/Stück *€/piece
8516405	M5L	80	43	32	SW3	10	1,80
8516406	M6L	90	50	35	SW4	10	2,10
8516408	M8L	130	65	55	SW5	10	3,50
8516410	M10L	150	75	55	SW7	10	4,80

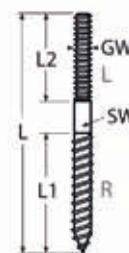

Mini-Augterminal / A4-AISI 316 Mini-eye terminal / Mini-embout à œil à sertir

8469

Artikel-Nr. Item-no.	DS-Ø WR-Ø	L1	iL	iD	S	D1	Box	*€/Stück *€/piece	
846942	2,0	38	18	4,5	4,5	3,0	10	2,00	NEW
8469425	2,5	38	18	5,5	4,5	3,0	10	2,00	NEW
846943	3,0	40	18	6,5	4,0	6,4	10	2,10	
846944	4,0	52	24	8,5	6,0	7,5	10	2,50	
846945	5,0	62	30	9,5	7,0	9,0	5	3,70	
846946	6,0	75	36	13,0	8,0	12,6	5	5,80	

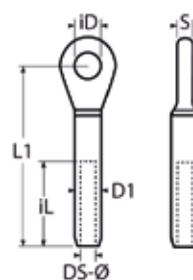

2

Spannschlösser, Terminals und Drahtseile

Turnbuckles, terminals and wire ropes

Tendeurs, ridoirs, embouts à sertir et câbles

8281

Augterminal / A4-AISI 316

Eye terminal / Embout à œil à sertir

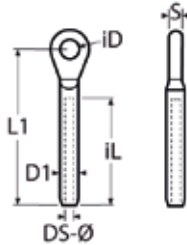

Artikel-Nr. Item-no.	DS-Ø WR-Ø	L1	iL	iD	D1	S	Box	*€/Stück *€/piece
NEW 8281402	2,0	48	25	5,4	5,5	3	10	2,00
82814025	2,5	49	30	5,4	5,5	3	10	2,10
8281403	3,0	55	36	6,5	6,4	4	10	2,20
8281404	4,0	56	39	8,5	7,5	6	10	2,80
8281405	5,0	80	50	10,5	9,0	7	5	4,10
8281406	6,0	94	62	12,5	12,6	8	5	6,30
8281407	7,0	105	68	12,7	14,2	9	5	8,10
8281408	8,0	124	85	14,5	16,0	10	1	12,00
8281410	10,0	142	90	16,4	17,8	12	1	22,20
8281412	12,0	160	105	19,3	20,0	16	1	25,20

814863

Auge mit Rechtsgewinde / A4-AISI 316

Eye with right thread / Œil avec filetage à droite

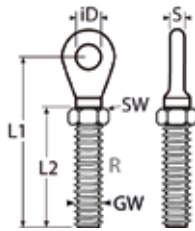

Artikel-Nr. Item-no.	GW	L1	L2	iD	S	Antrieb Drive	Box	*€/Stück *€/piece
NEW 814863404	M4	55	37	4,5	3	SW7	10	2,70
814863405	M5	60	42	5,5	3	SW8	10	2,80
814863406	M6	66	48	6,5	4	SW10	10	2,90
814863408	M8	78	56	8,5	5	SW13	5	3,10
814863410	M10	91	63	10,5	6	SW17	5	4,70
814863412	M12	112	80	13,0	8	SW19	5	6,50
NEW 814863414	M14	125	90	13,0	9	SW22	1	11,50
NEW 814863416	M16	135	100	14,5	10	SW27	1	17,00
NEW 814863420	M20	160	115	15,5	15,5	SW30	1	36,50

814864

Auge mit Linksgewinde / A4-AISI 316

Eye with left thread / Œil avec filetage à gauche

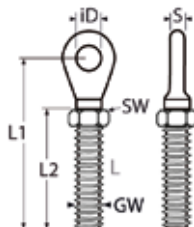

Artikel-Nr. Item-no.	GW	L1	L2	iD	S	Antrieb Drive	Box	*€/Stück *€/piece
NEW 814864404	M4	55	37	4,5	3	SW7	10	2,90
814864405	M5L	60	42	5,5	3	SW8	10	3,00
814864406	M6L	66	48	6,5	4	SW10	10	3,10
814864408	M8L	78	56	8,5	5	SW13	5	3,30
814864410	M10L	91	63	10,5	6	SW17	5	4,90
814864412	M12L	112	80	13,0	8	SW19	5	6,70
NEW 814864414	M14	125	90	13,0	9	SW22	1	11,70
NEW 814864416	M16	135	100	14,5	10	SW27	1	17,20
NEW 814864420	M20	160	115	15,5	15,5	SW30	1	36,70

Spannschlösser, Terminals und Drahtseile

Turnbuckles, terminals and wire ropes

Tendeurs, ridoirs, embouts à sertir et câbles

2

Mini-Auge mit Rechtsgewinde / A4-AISI 316

Mini-eye with right thread / Mini-œil avec filetage à droite

8454

Artikel-Nr. Item-no.	GW	L1	L2	iD	S	Box	*€/Stück *€/piece
8454404	M4	37	20	4,5	3	10	2,60
8454405	M5	45	23	5,5	3	10	2,70
8454406	M6	47	28	6,5	4	10	2,80
8454408	M8	55	40	8,5	5	5	3,00
8454410	M10	65	47	10,5	6	5	3,20

M4, M5 und M6 mit Teilgewinde / M4, M5 and M6 with partial thread / M4, M5 et M6 avec filetage partie
M8 und M10 mit Vollgewinde / M8 and M10 with full thread / M8 et M10 avec filetage complet

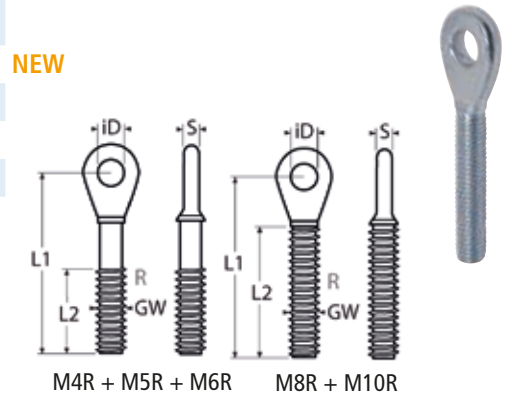

Mini-Auge mit Linksgewinde / A4-AISI 316

Mini-eye with left thread / Mini-œil avec filetage à gauche

8458

Artikel-Nr. Item-no.	GW	L1	L2	iD	S	Box	*€/Stück *€/piece
8458404	M4L	37	20	4,5	3	10	2,70
8458405	M5L	45	23	5,5	3	10	3,00
8458406	M6L	47	28	6,5	4	10	3,10
8458408	M8L	55	40	8,5	5	5	3,30
8458410	M10L	65	47	10,5	6	5	3,50

M4L, M5L und M6L mit Teilgewinde / M4L, M5L and M6L with partial thread / M4L, M5L et M6L avec filetage partie
M8L und M10L mit Vollgewinde / M8L and M10L with full thread / M8L et M10L avec filetage complet

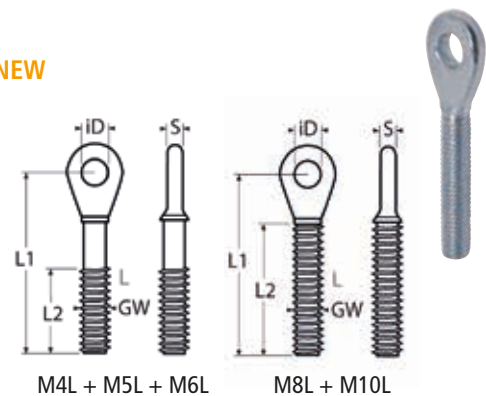

Auge mit Holzgewinde, MT-Serie / A4-AISI 316

Thread eye with wood thread, MT series / Embout à oeil fixe avec pas de vis, Série MT

815015

Artikel-Nr. Item-no.	GW	L1	L2	L3	iD	S	Box	*€/Stück *€/piece
815015405 065	5	65	50	55	5,5	3	10	2,80
815015406 065	6	65	50	55	6,5	4	10	3,40
815015408 085	8	85	60	70	8,5	5	5	4,80
815015410 090	10	90	60	70	10,5	6	5	7,90

Passend für Gabeln:

8386: Seite 68

8432, 8452, 8453, 8455: Seite 69

8280: Seite 81

8447, 814067: Seite 82

Fits for forks:

8386: page 68

8432, 8452, 8453, 8455: page 69

8280: page 81

8447, 814067: page 82

Approprié pour chape

8386: page 68

8432, 8452, 8453, 8455: page 69

8280: page 81

8447, 814067: page 82

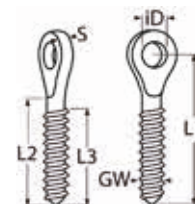

2

Spannschlösser, Terminals und Drahtseile

Turnbuckles, terminals and wire ropes

Tendeurs, ridoirs, embouts à sertir et câbles

8282

T-Terminal / A4-AISI 316

T-terminal / Embout en T à sertir

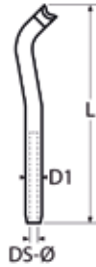

Artikel-Nr. Item-no.	DS-Ø WR-Ø	L	D1	Box	*€/Stück *€/piece
8282403	3	85	6,4	10	3,90
8282404	4	100	7,5	10	4,50
8282405	5	115	9,0	10	6,00
8282406	6	140	12,6	5	7,40
8282407	7	145	14,2	5	11,80
8282408	8	185	16,0	1	25,20
8282410	10	215	19,0	1	26,00

In Kombination mit Artikel 8302 | In combination with article 8302 | En combinaison avec d'article 8302

8302

Halteplatte für T-Terminal / A4-AISI 316

Back plate for T-terminal / Plaque d'ancrage pour embout en T



NEW

Artikel-Nr. Item-no.	DS-Ø WR-Ø	L	B	iL	iB	BD	Box	*€/Stück *€/piece
8302403	3	50	15	14,3	7,4	4,5	10	1,80
8302405	4+5	88	27	27,0	9,9	5,0	10	3,20
8302407	6+7	122	39	35,0	15,9	6,4	5	7,00
8302410	8+10	151	39	41,0	18,8	6,5	1	12,50

815100

Drehbares Terminal mit Presshülse, MT-Serie / A4-AISI 316

Rotatable terminal with crimping sleeve, MT-series / Terminaison rotative avec manchon, MT-séries



NEW

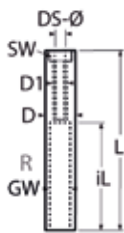

Artikel-Nr. Item-no.	GW	DS-Ø WR-Ø	L	iL	D	D1	Antrieb Drive	**BL kg	Box	*€/Stück *€/piece
815100406/2	M6	2	40	17	7	4,8	SW6	230	10	3,70
815100408/3	M8	3	50	25	10	5,5	SW8	420	10	5,20
815100408/4	M8	4	55	28	10	6,4	SW8	510	10	6,00
815100410/5	M10	5	65	30	12,5	7,5	SW10	960	6	8,40

Presshülse muss mit einer Pressbackengröße kleiner verpresst werden. Siehe Maßangabe D1.

**BL kg Auszugsfestigkeit gilt für Drahtseile der Konstruktion 7x7.

Crimping sleeve must be pressed with jaws one size smaller. Please check dimension D1.

**BL kg applies to wire ropes of construction 7x7.

Le manchon doit être traité avec une mâchoire de presse ou de rouleau de plus petite taille. Veuillez vérifier la dimension D1.

**BL kg s'applique aux câbles de construction 7x7.

Spannschlösser, Terminals und Drahtseile

Turnbuckles, terminals and wire ropes

Tendeurs, ridoirs, embouts à sertir et câbles

2



Presshülse für drehbares Terminal, MT-Serie / A4-AISI 316

Crimping sleeve for rotatable terminal, MT-series / Manchon pour terminaison rotative, MT-séries

815101

Artikel-Nr. Item-no.	DS-Ø WR-Ø	L	D	**BL kg	Box	*€/Stück *€/piece
81510142	2	17	4,8	230	25	0,90
81510143	3	17	5,5	420	25	1,00
81510144	4	19	6,4	510	20	1,10
81510145	5	25	7,5	960	20	1,60

Presshülse muss mit einer Pressbackengröße kleiner verpresst werden. Siehe Maßangabe D.

**BL kg gilt für Drahtseile der Konstruktion 7x7.

Crimping sleeve must be pressed with jaws one size smaller. Please check dimension D.

BL kg applies to wire ropes of construction 7x7.

Le manchon doit être traité avec une mâchoire de presse ou de rouleau de plus petite taille.

Veillez vérifier le dimension D. BL kg s'applique aux câbles de construction 7x7.



Gabelterminal / A4-AISI 316

Fork terminal / Embout à chape à sertir

8280

Artikel-Nr. Item-no.	DS-Ø WR-Ø	ø	L1	iL	iL1	iB	D1	Box	*€/Stück *€/piece
8280402	2,0	4,0	55	8,0	24	5,5	5,5	10	2,00
82804025	2,5	5,0	55	10,0	24	6,5	5,5	10	2,20
8280403	3,0	6,4	65	10,0	32	6,5	6,4	10	2,80
8280404-6	4,0	6,0	77	11,0	40	10,0	7,5	10	4,00
8280404	4,0	8,0	77	11,0	40	11,0	7,5	10	4,10
8280405	5,0	9,0	88	14,0	57	12,0	9,0	5	5,60
8280406	6,0	12,0	106	20,0	63	14,0	12,6	5	10,20
8280407	7,0	12,0	116	22,0	70	15,0	14,2	5	12,80
8280408	8,0	16,0	145	26,0	85	17,0	16,0	5	23,20
8280410	10,0	18,0	150	30,0	90	20,0	19,0	1	33,80
8280412	12,0	19,0	195	35,0	105	23,0	20,0	1	41,00
8280414	14,0	22,0	232	46,5	140	30,0	25,0	1	82,00
8280416	16,0	25,0	264	49,0	160	30,0	28,0	1	110,00



Mini-Gabelterminal / A4-AISI 316

Mini-fork terminal / Mini-embout à chape à sertir

8447

Artikel-Nr. Item-no.	DS-Ø WR-Ø	ø	L1	iL	iB	D1	Box	*€/Stück *€/piece
844743	3	5	55	10	8	6,4	10	3,00
844744	4	6	65	10	8	7,5	10	3,50
844745	5	8	70	12	10	9,0	5	5,70
844746	6	10	85	14	12	12,6	5	7,40

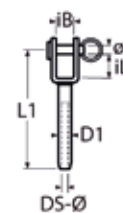

2

Spannschlösser, Terminals und Drahtseile

Turnbuckles, terminals and wire ropes

Tendeurs, ridoirs, embouts à sertir et câbles

814067

Gabelterminal, gedrehte Ausführung / A4-AISI 316

Fork terminal, machined / Embout à chape usinée à sertir

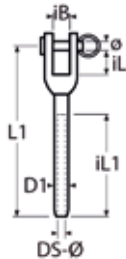

Artikel-Nr. Item-no.	DS-Ø WR-Ø	ø	L1	iL	iL1	iB	D1	Box	*€/Stück *€/piece
814067403	3	6	73	10	39	7,5	6,4	10	7,80
814067404	4	8	86	11	45	11	7,5	10	15,20
814067405	5	9	100	14	52	12	9,0	5	16,80
814067406	6	12	128	20	64	14	12,6	5	32,20
814067407	7	12	135	22	80	15	14,2	5	37,70
814067408	8	16	155	26	90	17	16,0	5	54,00

8483

Toggle-Terminal / A4-AISI 316

Toggle terminal / Embout à chape articulée à sertir

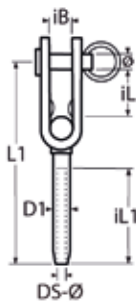

Artikel-Nr. Item-no.	DS-Ø WR-Ø	ø	L1	iL	iL1	iB	D1	Box	*€/Stück *€/piece
8483403	3	6	75	15	39	7	6,4	5	5,00
8483404	4	8	89	20	45	10	7,5	5	6,00
8483405	5	9	104	25	52	12	9,0	5	11,00
8483406	6	12	127	30	64	13	12,6	5	20,30
8483408	8	16	163	40	80	17	16,0	1	42,50
8483410	10	19	184	45	90	20	20,0	1	48,00

815016

Toggle Terminal zur Wandbefestigung, MT-Serie / A4-AISI 316

Wall mounting toggle terminal, MT series / Embout articulé mural à sertir, Série MT

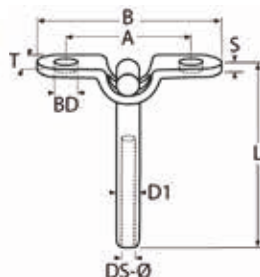

Artikel-Nr. Item-no.	DS-Ø WR-Ø	L	B	T	D1	A	S	BD	Box	*€/Stück *€/piece
815016403	3	53	50	20	6,4	35	3	6,3	5	4,60
815016404	4	63	50	20	7,5	35	3	6,3	5	5,10
815016405	5	68	60	25	9,0	40	3	8,4	2	6,40
815016406	6	79	75	30	12,6	50	4	10,5	2	9,70

Spannschlösser, Terminals und Drahtseile

Turnbuckles, terminals and wire ropes

Tendeurs, ridoirs, embouts à sertir et câbles

2

Toggle mit Rechtsgewinde / A4-AISI 316

Toggle with right thread / Chape articulée avec filetage à droite

8486

Artikel-Nr. Item-no.	GW	ø	L1	L2	iL	iB	Antrieb Drive	Box	*€/Stück *€/piece
8486405	M5	5	62	42	13	6	SW8	10	3,10
8486406	M6	6	77	48	15	7	SW10	10	4,20
8486408	M8	8	94	56	20	10	SW13	5	6,00
8486410	M10	9	115	67	25	12	SW17	5	11,00
8486412	M12	12	136	81	30	13	SW19	5	17,30
8486416	M16	16	163	103	40	17	SW24	1	38,10
8486420	M20	19	198	115	45	20	SW30	1	53,60

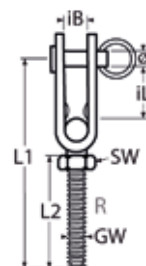

Toggle mit Linksgewinde / A4-AISI 316

Toggle with left thread / Chape articulée avec filetage à gauche

8503

Artikel-Nr. Item-no.	GW	ø	L1	L2	iL	iB	Antrieb Drive	Box	*€/Stück *€/piece
8503405	M5L	5	62	42	13	6	SW8	10	3,40
8503406	M6L	6	77	48	15	7	SW10	10	4,80
8503408	M8L	8	94	56	20	10	SW13	5	6,40
8503410	M10L	9	115	67	25	12	SW17	5	11,40
8503412	M12L	12	136	81	30	13	SW19	5	17,70
8503416	M16L	16	163	103	40	17	SW24	1	38,70
8503420	M20L	19	198	115	45	20	SW30	1	54,50

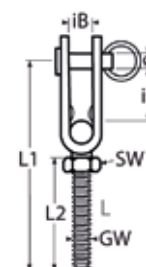

Toggle mit Gewinde zur Wandbefestigung, MT-Serie / A4-AISI 316

Wall mounting toggle with thread, MT series / Embout fileté articulé mural à sertir, Série MT

815017

Artikel-Nr. Item-no.	GW	L	L1	B	T	A	S	BD	Box	*€/Stück *€/piece
815017405	M5	55	40	50	20	35	3	6,3	5	4,70
815017405L	M5L	55	40	50	20	35	3	6,3	5	4,70
815017406	M6	57	40	50	20	35	3	6,3	5	5,00
815017406L	M6L	57	40	50	20	35	3	6,3	5	5,00
815017408	M8	68	50	60	25	40	3	8,4	2	6,40
815017408L	M8L	68	50	60	25	40	3	8,4	2	6,40
815017410	M10	74	50	75	30	50	4	10,5	2	9,60
815017410L	M10L	74	50	75	30	50	4	10,5	2	9,60

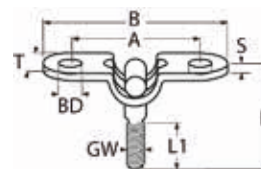

2

Spannschlösser, Terminals und Drahtseile

Turnbuckles, terminals and wire ropes

Tendeurs, ridoirs, embouts à sertir et câbles

8278

Toggle Gabel-Auge / A4-AISI 316

Toggle fork-eye / Articulation de chape

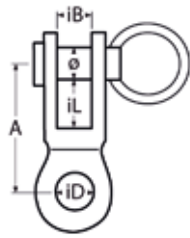

Artikel-Nr. Item-no.	ø	iD	iL	iB	A	**BL kg	Box	*€/Stück *€/piece
8278405	5,2	5,5	7	6	22	900	5	2,30
8278406	6,3	6,6	9	7	27	1100	5	2,80
8278408	8,3	8,5	10	10	31	2200	5	3,70
8278410	9,3	10,0	12	12	36	2700	1	5,90
8278412	12,4	13,0	17	13	50	4900	1	7,70
8278414	15,0	14,3	20	15	60	6800	1	12,60
8278416	17,0	17,0	29	14	80	7500	1	19,00

8403

DIY Montage-Augterminal / A4-AISI 316

DIY quick attach eye terminal / DIY embout à œill à sertissage manuel

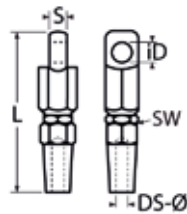

Artikel-Nr. Item-no.	DS-ø WR-ø	L	iD	S	Antrieb Drive	Box	*€/Stück *€/piece
8403404	4	67	8	6,5	SW14	1	34,50
8403405	5	80	10	8,0	SW16	1	37,20
8403406	6	95	12	9,0	SW19	1	49,60
8403408	8	119	14	10,0	SW24	1	83,50

Für Seile: 1x19 / 7x7 / 7x19 · BL= ca. 85% der Drahtseilbruchlast

For wire rope: 1x19 / 7x7 / 7x19 · BL= ca. 85% of wire rope breaking load

Pour câbles 1x19 / 7x7 / 7x19 · BL = ca. 85% de la charge de rupture du câble.



Technische Informationen

Technical information

Informations techniques

8404

DIY Montage-Gabelterminal / A4-AISI 316

DIY quick attach eye terminal / DIY embout à œill à sertissage manuel

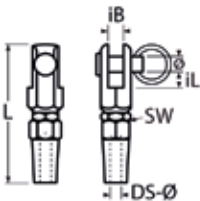

Artikel-Nr. Item-no.	DS-ø WR-ø	ø	L	iL	iB	Antrieb Drive	Box	*€/Stück *€/piece
8404404	4	8	72	8	8	SW14	1	36,50
8404405	5	10	82	10	10	SW16	1	49,90
8404406	6	12	94	12	12	SW19	1	50,30
8404408	8	14	116	14	14	SW24	1	76,00

Für Seile: 1x19 / 7x7 / 7x19 · BL= ca. 85% der Drahtseilbruchlast

For wire rope: 1x19 / 7x7 / 7x19 · BL= ca. 85% of wire rope breaking load

Pour câbles 1x19 / 7x7 / 7x19 · BL = ca. 85% de la charge de rupture du câble.



Technische Informationen

Technical information

Informations techniques

Spannschlösser, Terminals und Drahtseile

Turnbuckles, terminals and wire ropes

Tendeurs, ridoirs, embouts à sertir et câbles

2

DIY Montage-Gewindeterminal / A4-AISI 316

DIY quick attach eye terminal / DIY embout à œill à sertissage manuel

8406

Artikel-Nr. Item-no.	DS-Ø WR-Ø	GW	L	L1	Antrieb Drive	Box	*€/Stück *€/piece
8406404	4	M8	100	57	SW14	1	39,30
8406405	5	M10	117	63	SW16	1	50,20
8406406	6	M12	145	80	SW19	1	60,00
8406408	8	M16	182	100	SW24	1	87,30

Für Seile: 1x19 / 7x7 / 7x19 · BL= ca. 85% der Drahtseilbruchlast

For wire rope: 1x19 / 7x7 / 7x19 · BL= ca. 85% of wire rope breaking load

Pour câbles 1x19 / 7x7 / 7x19 · BL = ca. 85% de la charge de rupture du câble.

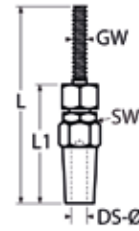

Technische Informationen
Technical information
Informations techniques

DIY Schraubterminal mit Innengewinde / A4-AISI 316

DIY terminal with internal thread / DIY embout avec filetage interne à sertissage man.

8451

Artikel-Nr. Item-no.	DS-Ø WR-Ø	GW	L	iL	iL1	D1	Box	*€/Stück *€/piece
8451434RE	3+4	M6	80	45	35	12	5	7,90
8451434LI	3+4	M6L	80	45	35	12	5	7,90
8451405RE	5	M6	80	45	35	12	5	7,90
8451405LI	5	M6L	80	45	35	12	5	7,90

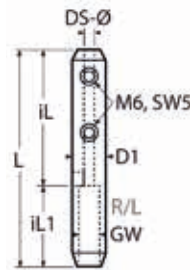

DIY Schraubterminal mit Gewindestift / A4-AISI 316

DIY terminal with set screw / DIY embout avec filetage externe à sertissage man.

814868

Artikel-Nr. Item-no.	DS-Ø WR-Ø	GW	L	L1	L2	D1	Box	*€/Stück *€/piece
814868405/3	3	M5	87	53	34	11	5	6,50
814868406/4	4	M6	95	58	37	13	5	7,50
814868406/5	5	M6	102	65	37	14	2	8,00
814868408/6	6	M8	118	73	45	16	2	10,50

Der Gewindestift ist herausdrehbar.

The grub screw is removable.

La vis sans tête est amovible.

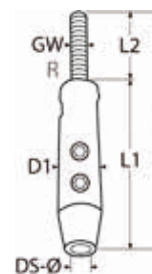

2

Spannschlösser, Terminals und Drahtseile

Turnbuckles, terminals and wire ropes

Tendeurs, ridoirs, embouts à sertir et câbles

8346

Wantenversteller / A4-AISI 316

Stay adjuster / Latte ridoir

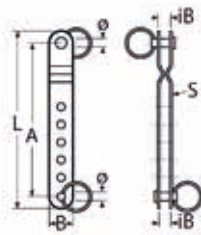

Artikel-Nr. Item-no.	Ø	L	B	iB	A	S	Box	*€/Stück *€/piece
83464104	5	104	15	10	87	1,5	5	8,40

8350

Wantenversteller / A2-AISI 304

Stay adjuster / Latte ridoir

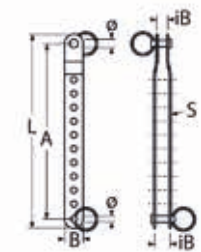

Artikel-Nr. Item-no.	Ø	L	B	iB	A	S	Box	*€/Stück *€/piece
83502100	5	100	15	9	84	1,5	5	6,80
83502155	5	155	15	9	145	1,5	5	8,10
83502200	5	200	15	9	184	1,5	5	12,50

8283

Pelikanhaken mit Innengewinde / A4-AISI 316

Pelican hook with internal thread / Crochet pélican avec filetage interne

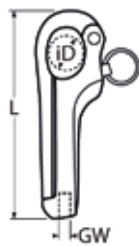

Artikel-Nr. Item-no.	GW	L	iD	**BL kg	Box	*€/Stück *€/piece
8283406	M6	75	15,0	570	1	7,60
8283408	M8	100	16,5	1030	1	11,50
8283410-125	M10	125	20,5	1590	1	25,20
8283410	M10	144	20,5	1590	1	27,40
8283412	M12	150	21,0	1750	1	28,00

814077

Pelikanhaken mit Auge / A4-AISI 316

Pelican hook with eye / Crochet pélican à œil

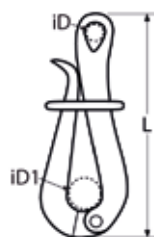

Artikel-Nr. Item-no.	L	iD	iD1	Box	*€/Stück *€/piece
8140774100	100	10	18	5	9,60
8140774150	150	13	22	5	18,20

Spannschlösser, Terminals und Drahtseile

Turnbuckles, terminals and wire ropes

Tendeurs, ridoirs, embouts à sertir et câbles

2

Sliphaken mit Ring / A4-AISI 316

Slip hook with ring / Ridoir pélican avec anneau

814167

Artikel-Nr. Item-no.	ø	L	B	iD	Box	*€/Stück *€/piece
8141674132 5	5	132	5,3	5,1	5	7,20
8141674142 6	6	142	7,0	6,2	5	7,50
8141674192 8	8	192	10,7	8,5	2	10,70
8141674235 12	12	235	13,7	13,0	2	24,00



2

Edelstahldrahtseil weich/flexibel 7x19 sZ / A2-AISI 304 / A4-AISI 316

Wire rope flexible 7x19 sZ / Câble extra-souple 7x19 sZ

8382

Artikel-Nr. A2 Item-no. A2	Artikel-Nr. A4 Item-no. A4	DS-Ø WR-Ø	**BL kg	Haspellänge m Reel length m	*€/m A2	*€/m A4
83822015100	83824015100	1,5	120	100	0,50	0,60
83822015250	83824015250	1,5	120	250	0,40	0,55
83822015	83824015	1,5	120	2000	0,30	0,50
8382202100	8382402100	2,0	210	100	0,60	0,70
8382202250	8382402250	2,0	210	250	0,50	0,65
8382202	8382402	2,0	210	2000	0,40	0,50
83822025100	83824025100	2,5	330	100	0,90	1,00
83822025250	83824025250	2,5	330	250	0,70	0,90
83822025	83824025	2,5	330	1000	0,50	0,70
8382203100	8382403100	3,0	480	100	0,90	1,20
8382203250	8382403250	3,0	480	250	0,70	1,10
8382203	8382403	3,0	480	1000	0,60	0,90
8382204100	8382404100	4,0	850	100	1,30	1,80
8382204250	8382404250	4,0	850	250	1,10	1,60
8382204	8382404	4,0	850	1000	0,90	1,30
8382205100	8382405100	5,0	1330	100	1,60	2,50
8382205250	8382405250	5,0	1330	250	1,40	2,20
8382205	8382405	5,0	1330	1000	1,20	1,90
8382206100	8382406100	6,0	1910	100	2,80	3,90
8382206250	8382406250	6,0	1910	250	2,60	3,50
8382206	8382406	6,0	1910	500	2,40	3,20
-	8382407250	7,0	2600	250	-	4,50
8382208100	8382408100	8,0	3390	100	4,20	5,60
8382208250	8382408250	8,0	3390	250	3,80	5,30
8382208	8382408	8,0	3390	500	3,50	5,10
-	8382410100	10,0	5310	100	-	8,60
-	8382410250	10,0	5310	250	-	8,30
-	8382410	10,0	5310	500	-	7,90
-	8382412250	12,0	7650	250	-	12,00
-	8382412	12,0	7650	500	-	11,20
-	8382414	14,0	10410	250	-	14,00
-	8382416250	16,0	13600	250	-	17,50

7x19

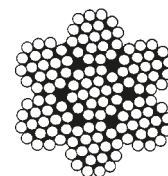

Spannschlösser, Terminals und Drahtseile

Turnbuckles, terminals and wire ropes

Tendeurs, ridoirs, embouts à sertir et câbles

815056

Edelstahldrahtseil, Duplex, weich/flexibel 7x19 sZ, MT-serie / D6-AISI 318 LN
Duplex wire rope flexible 7x19 sZ, MT-series / Câble en Duplex extra-souple 7x19 sZ, MT-séries



NEW



Artikel-Nr. Item-no.	DS-Ø WR-Ø	**BL kg	Haspellänge m Reel length m	*€/m
815056446203	3	530	250	2,30
815056446204	4	950	250	5,80
815056446205	5	1490	250	8,00
815056446206	6	2150	250	11,30
815056446208	8	3400	250	12,00

815082

Edelstahldrahtseil weich/flexibel 6x36 IWRC sZ / A4-AISI 316
Wire rope flexible 6x36 IWRC sZ / Cable extra-souple 6x36 IWRC sZ

NEW

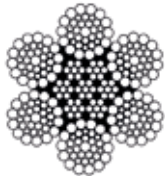

Artikel-Nr. Item-no.	DS-Ø WR-Ø	**BL kg	Haspellänge m Reel length m	*€/m
815082406250	6	1870	250	3,90
815082406500	6	1870	500	4,10
815082408250	8	3320	250	6,30
815082408500	8	3320	500	5,70
815082410250	10	5180	250	10,30
815082410500	10	5180	500	9,10
815082412250	12	7460	250	14,80
815082412500	12	7460	500	13,30
815082414250	14	10150	250	16,80
815082414500	14	10150	500	15,70
815082416250	16	13260	250	22,20
815082416500	16	13260	500	21,10
815082418250	18	16800	250	30,20
815082418500	18	16800	500	25,80
815082420250	20	20700	250	34,00
815082420500	20	20700	500	32,20
815082422250	22	25100	250	43,30
815082422500	22	25100	500	39,00
815082424250	24	29800	250	59,50

815055

Edelstahldrahtseil, Duplex, mittelweich 7x7 sZ, MT-Serie / D6-AISI 318 LN
Duplex wire rope semi-soft 7x7 sZ, MT-series / Câble en Duplex souple 7x7 sZ, MT-Séries



NEW



Artikel-Nr. Item-no.	DS-Ø WR-Ø	**BL kg	Haspellänge m Reel length m	*€/m
815055446203	3	580	250	1,90
815055446204	4	1030	250	3,20
815055446205	5	1620	250	4,90
815055446206	6	2330	250	6,90
815055446208	8	4140	250	12,00

Spannschlösser, Terminals und Drahtseile

Turnbuckles, terminals and wire ropes

Tendeurs, ridoirs, embouts à sertir et câbles

2

Edelstahldrahtseil mittelweich 7x7 sZ / A2-AISI 304 / A4-AISI 316
Wire rope semi-soft 7x7 sZ / Câble souple 7x7 sZ

8379

Artikel-Nr. A2 Item-no. A2	Artikel-Nr. A4 Item-no. A4	DS-Ø WR-Ø	**BL kg	Haspellänge m Reel length m	*€/m A2	*€/m A4
8379201100	8379401100	1,0	60	100	0,30	0,40
8379201250	8379401250	1,0	60	250	0,20	0,30
8379201	8379401	1,0	60	2000	0,15	0,20
83792015100	83794015100	1,5	130	100	0,30	0,50
83792015250	83794015250	1,5	130	250	0,20	0,40
83792015	83794015	1,5	130	2000	0,15	0,30
8379202100	8379402100	2,0	230	100	0,50	0,60
8379202250	8379402250	2,0	230	250	0,40	0,50
8379202	8379402	2,0	230	2000	0,30	0,40
83792025100	83794025100	2,5	360	100	0,60	0,80
83792025250	83794025250	2,5	360	250	0,50	0,70
83792025	83794025	2,5	360	1000	0,40	0,60
8379203100	8379403100	3,0	510	100	0,80	1,00
8379203250	8379403250	3,0	510	250	0,70	0,90
8379203	8379403	3,0	510	1000	0,60	0,80
8379204100	8379404100	4,0	910	100	1,10	1,60
8379204250	8379404250	4,0	910	250	1,00	1,40
8379204	8379404	4,0	910	1000	0,80	1,30
8379205100	8379405100	5,0	1430	100	1,60	2,30
8379205250	8379405250	5,0	1430	250	1,40	2,10
8379205	8379405	5,0	1430	1000	1,20	1,80
8379206100	8379406100	6,0	2060	100	2,50	3,80
8379206250	8379406250	6,0	2060	250	2,30	3,10
8379206	8379406	6,0	2060	500	2,00	2,90
-	8379407250	7,0	2810	250	-	4,10
8379208100	8379408100	8,0	3670	100	4,00	5,20
8379208250	8379408250	8,0	3670	250	3,70	4,90
8379208	8379408	8,0	3670	500	3,20	4,70
-	8379410100	10,0	5740	100	-	8,00
-	8379410250	10,0	5740	250	-	7,70
-	8379410	10,0	5740	500	-	6,90
-	8379412250	12,0	8270	250	-	12,30
-	8379412	12,0	8270	500	-	11,00

7x7

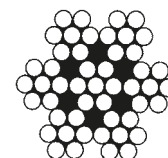

2

NEW

Edelstahldrahtseil 8x7+PP "Entmistingsseil" / A2-AISI 304
Wire rope 8x7+PP "Manure scraper rope" / Câble 8x7+PP "Câble d'enlèvement du fumier"

815161

Artikel-Nr. Item-no.	DS-Ø WR-Ø	**BL kg	Haspellänge m Reel length m	*€/m
815161208250	8	3140	250	3,20
815161210250	10	4910	250	5,00

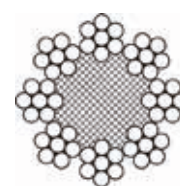

2

Spannschlösser, Terminals und Drahtseile

Turnbuckles, terminals and wire ropes

Tendeurs, ridoirs, embouts à sertir et câbles

814593

Edelstahldrahtseil 7x7 sZ PVC klar ummantelt / A4-AISI 316 / PVC

Wire rope 7x7 sZ PVC clear coated / Câble souple 7x7 sZ gainé PVC transparent



7x7

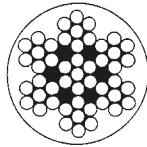

Artikel-Nr. Item-no.	DS-Ø WR-Ø	ø	**BL kg	Haspellänge m Reel length m	*€/m
81459341/15250	1,0	1,5	60	250	0,50
8145934125/2250	1,25	2,0	90	250	0,60
81459342/3250	2,0	3,0	230	250	0,70
81459343/4250	3,0	4,0	510	250	1,20
81459344/5250	4,0	5,0	910	250	1,60
81459345/7250	5,0	7,0	1430	250	2,80

8381

Edelstahldrahtseil 7x7 sZ PVC weiß ummantelt / A4-AISI 316 / PVC

Wire rope 7x7 sZ PVC white coated / Câble souple 7x7 sZ gainé PVC blanc



7x7

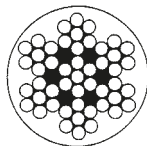

Artikel-Nr. Item-no.	DS-Ø WR-Ø	ø	**BL kg	Haspellänge m Reel length m	*€/m
838143/5250	3	5	510	250	1,40
838144/6250	4	6	910	250	1,90
838144/6	4	6	910	1000	1,60
838144/7250	4	7	910	250	2,30
838144/7	4	7	910	1000	2,00
838145/7250	5	7	1430	250	2,90
838146/9250	6	9	2060	250	3,90

Relingsdrahtset siehe Seite 131 | Guard rail set see page 131 | Kit de montage pour filière voir page 131

815104

Edelstahldrahtseil 7x19 sZ PVC, klar ummantelt / A4-AISI 316 / PVC

Wire rope 7x19 sZ PVC clear coated / Câble souple 7x19 sZ gainé PVC transparent

NEW

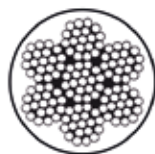

Artikel-Nr. Item-no.	DS-Ø WR-Ø	ø	**BL kg	Haspellänge m Reel length m	*€/m
815104404/5250	4	5	850	250	2,20
815104405/7250	5	7	1330	250	3,40
815104408/10250	8	10	3390	250	6,90
815104410/12250	10	12	5310	250	10,80

816012

Edelstahldrahtseil 7x7 sZ PVC, farbig ummantelt / A4-AISI 316 / PVC

Wire rope 7x7 sZ PVC colour coated / Câble souple 7x7 sZ gainé PVC coloré

NEW



Artikel-Nr. Item-no.	DS-Ø WR-Ø	ø	Farbe Colour	**BL kg	Haspellänge m Reel length m	*€/m
81601243/5RO	3	5	Rot / Red RAL 3000	510	1000	1,90
81601243/5RO250	3	5	Rot / Red RAL 3000	510	250	2,20
81601244/6SC	4	6	Schwarz / Black RAL 9005	910	1000	2,20
81601244/6SC250	4	6	Schwarz / Black RAL 9005	910	250	2,60
81601245/7SC	5	7	Schwarz / Black RAL 9005	1430	1000	2,90
81601245/7SC250	5	7	Schwarz / Black RAL 9005	1430	250	3,60

Spannschlösser, Terminals und Drahtseile

Turnbuckles, terminals and wire ropes
Tendeurs, ridoirs, embouts à sertir et câbles

2

Edelstahldrahtseil hart/steif 1x19 sZ / A4-AISI 316 Wire rope hard/stiff 1x19 sZ / Câble rigide 1x19 sZ

8378

Artikel-Nr. Item-no.	DS-Ø WR-Ø	**BL kg	Haspellänge m Reel length m	*€/m
8378401250	1,0	80	250	0,40
8378401	1,0	80	2000	0,30
83784015250	1,5	180	250	0,50
83784015	1,5	180	2000	0,40
8378402250	2,0	330	250	0,60
8378402	2,0	330	2000	0,40
83784025250	2,5	520	250	0,90
83784025	2,5	520	1000	0,70
8378403250	3,0	750	250	1,20
8378403	3,0	750	1000	1,00
8378404250	4,0	1340	250	1,80
8378404	4,0	1340	1000	1,60
8378405250	5,0	2100	250	2,60
8378405	5,0	2100	1000	2,30
8378406250	6,0	3020	250	3,70
8378406	6,0	3020	500	3,50
8378407250	7,0	4120	250	5,80
8378408250	8,0	5380	250	6,00
8378408	8,0	5380	500	5,80
8378410250	10,0	8400	250	10,50
8378412250	12,0	12100	500	12,50
8378412	12,0	12100	500	11,50

1x19

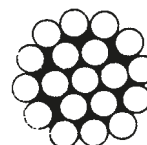

2

Drahtseil steif/hart 1x19 sZ, made in Korea / A4-AISI 316 Wire rope hard/stiff 1x19 sZ, made in korea / Câble rigide 1x19 sZ, fabriqué en corée

814931

Artikel-Nr. Item-no.	DS-Ø WR-Ø	**BL kg	Haspellänge m Reel length m	*€/m
814931402250	2,0	330	250	0,90
8149314025250	2,5	520	250	1,20
814931403250	3,0	750	250	1,60
814931404250	4,0	1340	250	2,30
814931405250	5,0	2100	250	3,80
814931406250	6,0	3020	250	5,20
814931407100	7,0	4120	100	7,80
814931407250	7,0	4120	250	7,50
814931408100	8,0	5380	100	9,40
814931408250	8,0	5380	250	9,00
814931410100	10,0	8400	100	15,00
814931410250	10,0	8400	250	14,60
814931412100	12,0	12100	100	19,50
814931412250	12,0	12100	250	18,90

1x19

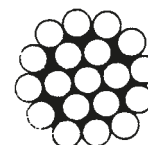

Made in Korea



Spannschlösser, Terminals und Drahtseile

Turnbuckles, terminals and wire ropes

Tendeurs, ridoirs, embouts à sertir et câbles

814979

Drahtseil-Set / A4-AISI 316

Wire rope set / Kit de câble

Drahtseil- \varnothing : 2 mm / Wire rope- \varnothing : 2 mm / Kit de câble- \varnothing : 2 mm

Artikel-Nr. Item-no.	Set	Länge Length	Kausche Thimble	Duplexklemme Duplex clip	Spannschloss Turnbuckle	Box	*€/Stück *€/piece
81497942-010	S	10 m	4 x	4 x	2 x M4	1	25,00
81497942-025	M	25 m	10 x	10 x	5 x M4	1	39,00
81497942-050	L	50 m	20 x	20 x	10 x M4	1	59,00
81497942-250	XL*	250 m	50 x	50 x	25 x M4	1	210,00

Drahtseil- \varnothing : 3 mm / Wire rope- \varnothing : 3 mm / Kit de câble- \varnothing : 3 mm

Artikel-Nr. Item-no.	Set	Länge Length	Kausche Thimble	Duplexklemme Duplex clip	Spannschloss Turnbuckle	Box	*€/Stück *€/piece
81497943-010	S	10 m	4 x	4 x	2 x M6	1	29,00
81497943-025	M	25 m	10 x	10 x	5 x M6	1	59,00
81497943-050	L	50 m	20 x	20 x	10 x M6	1	79,00
81497943-200	XL*	200 m	50 x	50 x	25 x M6	1	279,00

Drahtseil- \varnothing : 4 mm / Wire rope- \varnothing : 4 mm / Kit de câble- \varnothing : 4 mm

Artikel-Nr. Item-no.	Set	Länge Length	Kausche Thimble	Duplexklemme Duplex clip	Spannschloss Turnbuckle	Box	*€/Stück *€/piece
81497944-010	S	10 m	4 x	4 x	2 x M8	1	39,00
81497944-025	M	25 m	10 x	10 x	5 x M8	1	65,00
81497944-050	L	50 m	20 x	20 x	10 x M8	1	89,00
81497944-150	XL*	150 m	50 x	50 x	25 x M8	1	339,00



+



***Set XL**

inkl. KNIPEX® Drahtseilschere

Incl. KNIPEX® wire rope cutter

Incl. cisaille pour câble KNIPEX®

Spannschlösser, Terminals und Drahtseile

Turnbuckles, terminals and wire ropes

Tendeurs, ridoirs, embouts à sertir et câbles

2

Relingdrahtset, zur Selbstmontage / A4-AISI 316

Guardrail set for self mounting / Kit de montage pour filière

8475

Artikel-Nr. Item-no.	Ausführung Type	Box	*€/Stück *€/piece
8475477	Komplettsset Complete set	Rechts / Links Right / left	1 45,00
84754LINKS	¹ Ersatzset ¹ Replacement set	Links Left	1 9,00
84754RECHTS	² Ersatzset ² Replacement set	Rechts Right	1 9,00

Komplettsset:

10m Drahtseil 7x7 4/7mm, PVC weiß ummantelt
 1 Schraubterminal mit Rechtsgewinde
 1 Schraubterminal mit Linksgewinde
 1 Gabel mit Rechtsgewinde und Mutter
 1 Gabel mit Linksgewinde und Mutter
 6 Innensechskantschrauben und 1 Schlüssel

¹Ersatzset, links:

1 Schraubterminal mit Linksgewinde
 1 Gabel mit Linksgewinde und Mutter
 3 Innensechskantschrauben und 1 Schlüssel

²Ersatzset, rechts:

1 Schraubterminal mit Rechtsgewinde
 1 Gabel mit Rechtsgewinde und Mutter
 3 Innensechskantschrauben und 1 Schlüssel

Complete set:

10m wire rope 7x7 4/7mm, PVC white coated
 1 quick attach terminal with right thread
 1 quick attach terminal with left thread
 1 threaded fork with right thread and nut
 1 threaded fork with left thread and nut
 6 hexagon socket screws and 1 key

¹Replacement set, left:

1 quick attach terminal with left thread
 1 threaded fork with left thread and nut
 3 hexagon socket screws and 1 key

²Replacement set, right:

1 quick attach terminal with right thread
 1 threaded fork with right thread and nut
 3 hexagon socket screws and 1 key

Set complet:

10m câble 7x7 4/7mm, PVC gainé blanc
 1 serre câble avec filetage interne, droite
 1 serre câble avec filetage interne, gauche
 1 embout à chape fixe, droite inclus écrou
 1 Embout à chape fixe, gauche inclus écrou
 6 vis à six pans creux et 1 clé

¹Set de remplacement, gauche:

1 serre câble avec filetage interne, gauche
 1 Embout à chape fixe, gauche inclus écrou
 3 vis à six pans creux et 1 clé

²Set de remplacement, droite:

1 serre câble avec filetage interne, droite
 1 Embout à chape fixe, droite inclus écrou
 3 vis à six pans creux et 1 clé



Spannschlösser, Terminals und Drahtseile

Turnbuckles, terminals and wire ropes

Tendeurs, ridoirs, embouts à sertir et câbles

8247

Kausche / A4-AISI 316

Thimble / Cosse cœur

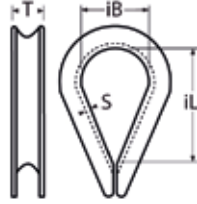

Artikel-Nr. Item-no.	DS-Ø WR-Ø	iL	iB	S	T	Box	*€/Stück *€/piece
8247402	2,0	10	7	0,7	4,0	200	0,20
82474025	2,5	14	8	0,7	4,5	200	0,30
8247403	3,0	15	9	1,0	5,5	200	0,30
8247404	4,0	18	11	1,0	6,0	200	0,40
8247405	5,0	20	14	1,2	7,5	200	0,40
8247406	6,0	26	15	1,2	9,0	200	0,50
8247407	7,0	27	15	1,2	10,0	100	0,80
8247408	8,0	29	18	1,5	12,0	100	0,90
8247410	10,0	37	24	1,5	14,5	50	1,10
8247412	12,0	50	29	1,5	18,0	50	1,60
8247414	14,0	54	33	2,0	21,0	25	2,60
8247416	16,0	64	37	2,0	23,0	25	3,50
8247418	18,0	70	40	2,5	24,0	25	4,50
8247420	20,0	75	45	2,5	28,0	10	5,40
8247422	22,0	88	53	2,5	33,0	10	8,10
8247424	24,0	92	58	3,0	33,0	10	13,00

8536

Kausche, schwere Ausführung / A4-AISI 316

Thimble, heavy duty / Cosse cœur arrondie

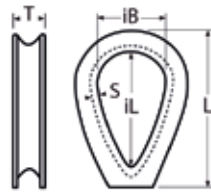

Artikel-Nr. Item-no.	DS-Ø WR-Ø	L	iL	iB	T	S	Box	*€/Stück *€/piece
8536402	2	21	15	9	5	1,6	50	1,80
8536403	3	26	18	11	6	2,0	50	1,90
8536404	4	32	21	14	7	3,0	50	2,00
8536405	5	42	28	15	9	4,5	25	2,50
8536406	6	43	28	17	11	2,6	25	3,50
8536408	8	58	43	24	10	3,2	25	3,70
8536410	10	68	51	28	13	5,0	25	5,60
8536412	12	86	62	37	16	5,0	10	8,50
8536414	14	100	74	39	19	8,5	10	12,30
8536416	16	110	82	47	20	6,5	5	19,30
8536419	19	124	94	60	24	4,5	5	27,40
8536422	22	126	100	63	28	5,5	1	28,40
8536425	25	146	115	74	32	6,0	1	40,00

Spannschlösser, Terminals und Drahtseile

Turnbuckles, terminals and wire ropes

Tendeurs, ridoirs, embouts à sertir et câbles

2



Kausche Duplex, schwere Ausführung, MT-Serie / D6-AISI 318 LN

Duplex thimble, heavy duty, MT-series / Cosse cœur arrondie en Duplex, MT-séries

815058

NEW

Artikel-Nr. Item-no.	DS-Ø WR-Ø	L	iL	iB	T	S	Box	*€/Stück *€/piece
815058446203	3	25	17	10	5,8	2,1	5	2,50
815058446204	4	33	23	13	7,4	2,8	5	2,30
815058446205	5	41	28	16	9,0	3,5	5	3,50
815058446206	6	49	34	19	10,6	4,2	5	4,50
815058446208	8	62	42	22	13,3	5,6	2	7,10

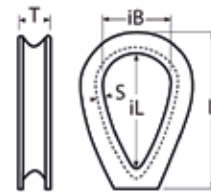

2

Kausche mit Steg / A4-AISI 316

Thimble with bar / Cosse-cœur renfort soudé

8636

Artikel-Nr. Item-no.	DS-Ø WR-Ø	L	iL	iB	S	T	Box	*€/Stück *€/piece
8636406	6	37	11	14	1,2	11,5	25	7,80
8636408	8	50	15	19	1,5	13,5	25	8,30
8636410	10	53	21	26	2,0	14,5	10	9,00
8636412	12	60	25	27	2,5	16,0	10	11,00
8636414	14	74	30	34	2,5	19,0	10	13,60
8636416	16	83	30	40	2,5	23,0	5	15,50
8636418	18	92	32	41	2,0	25,0	5	19,00
8636420	20	104	35	46	2,0	28,0	5	21,00

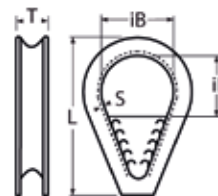

NEW

Rohrkausche / A4-AISI 316

Tube thimble / Cosse pour tube

815061

Artikel-Nr. Item-no.	Für Seil-Ø For rope-Ø	iD	iL	iB	T	S	Box	*€/Stück *€/piece
815061406	6	6,7	35	15	10,0	1,5	5	4,10
815061408	8	10,0	50	18	15,0	1,8	5	8,00
815061410	10	11,7	60	23	16,3	1,8	5	14,20
815061412	12	15,6	75	28	20,9	2,5	2	23,60
815061414	14	18,3	87	34	23,9	3,0	2	25,00
815061416	16	22,7	97	40	29,2	3,0	2	32,40
815061420	20	24,3	125	50	30,6	3,0	1	33,00
815061422	22	30,3	137	55	36,6	3,0	1	52,40
815061426	26	32,6	160	65	40,5	4,0	1	67,30
815061432	32	39,0	192	80	49,5	6,0	1	151,60

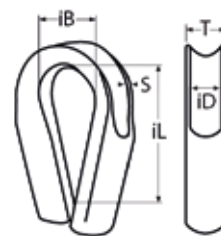

814453

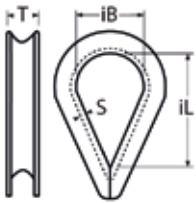
Nylon Kausche / Nylon-PA6
Nylon thimble / Cosse cœur en nylon

	Artikel-Nr. Item-no.	Für Seil-Ø For rope-Ø	Farbe Colour	iL	iB	T	S	Box	*€/Stück *€/piece
	814453304	4	Weiß / White	19	13	7	2	250	0,40
NEW	814453304BL	4	Schwarz / Black	19	13	7	2	250	0,40
	814453306	6	Weiß / White	22	16	8	2	250	0,50
NEW	814453306BL	6	Schwarz / Black	22	16	8	2	250	0,50
	814453308	8	Weiß / White	38	23	10	2	250	0,70
NEW	814453308BL	8	Schwarz / Black	38	23	10	2	250	0,70
	814453310	10	Weiß / White	40	24	13	3	100	0,90
NEW	814453310BL	10	Schwarz / Black	40	24	13	3	100	0,90
	814453312	12	Weiß / White	41	24	15	3	100	1,00
NEW	814453312BL	12	Schwarz / Black	41	24	15	3	100	1,00
	814453314	14	Weiß / White	44	26	17	3	50	1,40
NEW	814453314BL	14	Schwarz / Black	44	26	17	3	50	1,40
	814453316	16	Weiß / White	54	34	19	5	50	2,10
NEW	814453316BL	16	Schwarz / Black	54	34	19	5	50	2,10
	814453318	18	Weiß / White	56	34	21	6	25	2,70
NEW	814453318BL	18	Schwarz / Black	56	34	21	6	25	2,70
	814453320	20	Weiß / White	57	35	25	6	25	3,80
NEW	814453320BL	20	Schwarz / Black	57	35	25	6	25	3,80

Spannschlösser, Terminals und Drahtseile

Turnbuckles, terminals and wire ropes

Tendeurs, ridoirs, embouts à sertir et câbles

2

GleisteinRopes
The Perfect Line

Alu-Rundkausche mit/ohne gespießter Schlaufe / Alu / PE
Alu low friction ring with/without spliced loop / Anneau en aluminium avec/sans boucle de corde

814984

Artikel-Nr. Item-no.	(Für) Seil-Ø (For) rope-Ø	iL	iD	D	B	**BL kg	Box	*€/Stück *€/piece
814984005LOOP	*4	100	7	18	9	660	2	24,90
814984005	5	–	7	18	9	1220	5	10,00
814984007LOOP	*6	130	10	25	12	1280	2	27,90
814984007	7	–	10	25	12	2030	5	12,00
814984010LOOP	*9	160	14	35	15	3000	1	34,90
814984010	10	–	14	35	15	3000	2	13,00
814984014LOOP	*12	220	20	50	22	5500	1	71,50
814984014	14	–	20	50	22	5500	2	15,00

*Schlaufe/Tauwerk aus HMPE von Gleistein

*Loop/Rope made of HMPE from Gleistein

*Boucle de corde en HMPE de Gleistein

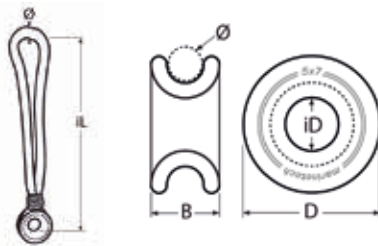

Drahtseilklemme / A4-AISI 316
Wire rope clip / Serre-câble étrier

8248

Artikel-Nr. Item-no.	DS-Ø WR-Ø	GW	Antrieb Drive	Box	*€/Stück *€/piece
8248402	2	M3	SW5,5	100	1,00
8248403	3	M3	SW5,5	100	1,10
8248403-4	3	M4	SW7	50	1,30
8248404	4	M4	SW7	100	1,30
8248405	5	M5	SW8	100	1,50
8248406	6	M6	SW10	25	1,70
8248408	8	M6	SW10	25	2,30
8248410	10	M8	SW13	25	3,80
8248412	12	M10	SW17	10	5,90
8248413	13	M10	SW17	10	6,00
8248416	16	M10	SW17	10	8,90
8248418	19	M12	SW19	5	12,70
8248422	22	M12	SW19	5	17,50

NEW

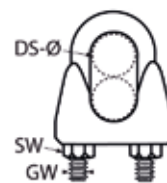

Technische Informationen
Technical information
Informations techniques

DS-Ø = max. Drahtseildurchmesser. Bei Drahtseil-Zwischengrößen ist die nächstgrößere Drahtseilklemme zu wählen.

WR-Ø = max. wire rope diameter. Wire ropes with intermediate diameters must be fixed with the next larger wire rope clip.

DS-Ø / WR-Ø = diamètre maximal du câble. Les câbles d'acier de diamètre intermédiaire doivent être fixés à l'aide de la pince à câble de taille immédiatement supérieure.



815059

Drahtseilklemme Duplex, MT-Serie / D6-AISI 318 LN
 Duplex wire rope clip, MT-series / Serre-câble étrier en Duplex, MT-séries

NEW

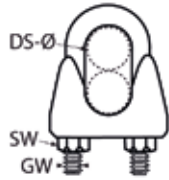

Artikel-Nr. Item-no.	DS-Ø WR-Ø	GW	Antrieb Drive	Box	*€/Stück *€/piece
815059446203	3	M3	SW5,5	20	2,30
815059446204	4	M4	SW7	10	2,80
815059446205	5	M5	SW8	10	3,40
815059446206	6	M6	SW10	10	3,70
815059446208	8	M6	SW10	5	4,30



Technische Informationen

Technical information

Informations techniques

814391

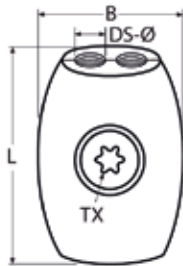
Eiform Drahtseilklemme / A4-AISI 316
 Egg shaped wire rope clip / Serre-câble œuf

Artikel-Nr. Item-no.	DS-Ø WR-Ø	GW	L	B	Antrieb Drive	Box	*€/Stück *€/piece
814391402	2	M5	28	15	TX25	10	6,50
814391403	3	M5	28	15	TX25	10	7,20
814391404	4	M6	34	19	TX30	10	8,00
814391405	5	M6	34	20	TX30	10	9,40
814391406	6	M6	35	24	TX30	10	10,90

8304

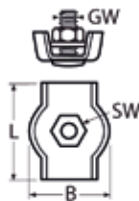
Simplex Drahtseilklemme / A4-AISI 316
 Simplex wire rope clip / Serre-câble plat simple

Artikel-Nr. Item-no.	DS-Ø WR-Ø	GW	L	B	Antrieb Drive	Box	*€/Stück *€/piece
8304402	2	M4	15	11,5	SW7	50	0,50
8304403	3	M4	18	14,5	SW7	50	0,60
8304404	4	M5	20	16,5	SW8	50	1,00
8304405	5	M5	24	20,0	SW8	25	1,20
8304406	6	M6	29	24,5	SW10	25	1,90
8304408	8	M8	35	31,5	SW13	25	3,50
8304410	10	M10	48	38,0	SW17	10	4,90

Spannschlösser, Terminals und Drahtseile

Turnbuckles, terminals and wire ropes
Tendeurs, ridoirs, embouts à sertir et câbles

2

Duplex Drahtseilklemme / A4-AISI 316 Duplex wire rope clip / Serre-câble plat double

8284

Artikel-Nr. Item-no.	DS-Ø WR-Ø	GW	L	B	Antrieb Drive	Box	*€/Stück *€/piece
8284402	2	M4	33	11,5	SW7	50	1,40
8284403	3	M4	38	14,5	SW7	50	1,40
8284404	4	M5	43	16,5	SW8	50	1,70
8284405	5	M5	51	20,0	SW8	25	2,50
8284406	6	M6	63	24,5	SW10	25	3,30
8284408	8	M8	78	31,5	SW13	25	5,60
8284410	10	M10	85	38,0	SW17	10	9,20



Klemmstopper / A4-AISI 316 Wire rope stopper / Bague d'arrêt pour câble

814722

Artikel-Nr. Item-no.	DS-Ø WR-Ø	GW	L	D	Antrieb Drive	Box	*€/Stück *€/piece
814722402	2	M4	8	10	SW2	10	2,80
814722403	3	M6	12	15	SW3	10	2,90
814722404	4	M8	12	15	SW4	10	3,40
814722405	5	M10	15	20	SW5	10	3,50
814722406	6	M10	15	20	SW5	10	3,90
814722408	8	M12	15	28	SW6	10	5,70

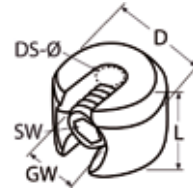

NEW

Kreuzklemme mit Sackgewinde / A4-AISI 316 Wire rope cross clip with blind thread / Serre-câble croisé fond fermé

8424

Artikel-Nr. Item-no.	DS-Ø WR-Ø	GW	L	D	Antrieb Drive	Box	*€/Stück *€/piece
842442	2	M12	20	19	SW6	10	5,60
842443	3	M12	19	20	SW6	10	5,80
842444	4	M12	21	20	SW6	10	5,90
842445	5	M12	23	20	SW6	10	6,00
842446	6	M12	25	20	SW6	10	7,00

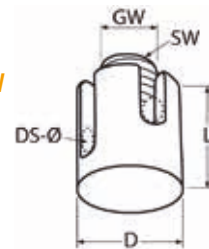

NEW

Kreuzklemme mit Durchgangsgewinde / A4-AISI 316 Wire rope cross clip with through-hole thread / Serre-câble croisé fond ouvert

814817

Artikel-Nr. Item-no.	DS-Ø WR-Ø	GW	L	D	Antrieb Drive	Box	*€/Stück *€/piece
81481743	3	M10	19	17	SW5	10	6,20
81481744	4	M12	21	20	SW6	10	8,70
81481745	5	M12	23	20	SW6	10	9,00



Spannschlösser, Terminals und Drahtseile

Turnbuckles, terminals and wire ropes

Tendeurs, ridoirs, embouts à sertir et câbles

815068

Kreuzklemme 0-90° / A4-AISI 316

Wire rope net clip 0-90° / Serre-câble croisé réglable 0-90°

NEW

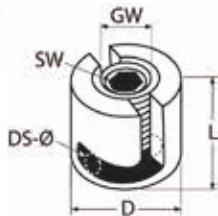

Artikel-Nr. Item-no.	DS-Ø WR-Ø	L	D	GW	Antrieb Drive	Box	*€/Stück *€/piece
815068402	2	16,5	20	M12	SW6	5	9,70
815068403	3	18,5	20	M12	SW6	5	11,80
815068404	4	20,5	20	M12	SW6	5	12,30
815068405	5	22,5	20	M12	SW6	5	13,20
815068406	6	24,5	20	M12	SW6	5	13,60



815069

Kreuzklemme 0-90° mit M10 Anschluß / A4-AISI 316

Wire rope net clip 0-90° with M10 connection / Serre-câble croisé 0-90° avec connexion M10

NEW

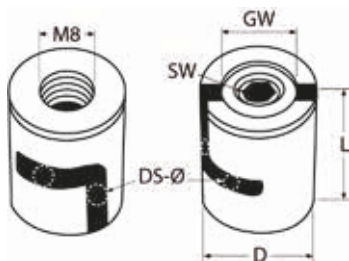

Artikel-Nr. Item-no.	DS-Ø WR-Ø	L	D	GW	Antrieb Drive	Box	*€/Stück *€/piece
815069402	2	25	20	M12	SW6	5	10,90
815069403	3	27	20	M12	SW6	5	11,20
815069404	4	29	20	M12	SW6	5	11,40
815069405	5	31	20	M12	SW6	5	12,20
815069406	6	33	20	M12	SW6	5	12,70

Zu empfehlen mit Stockschrauben M10 als Halterung für Drahtseilnetze oder Rankgitter.

Recommended with hanger bolts M10 as wall brackets for wire rope nets or trellis.

Recommandé avec des boulons de suspension M10 comme support pour filets ou treillis en câble.



815091

Kugel-Klemmstopper, geschliffen / A4-AISI 316

Wire rope ball stopper, grinded surface / Butée de boule de câble, surface poncée

NEW

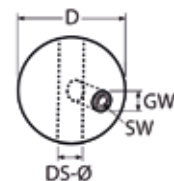

Artikel-Nr. Item-no.	DS-Ø WR-Ø	D	GW	Antrieb Drive	Box	*€/Stück *€/piece
815091403 15	3	15	M4	SW2	10	5,70
815091404 20	4	20	M5	SW2,5	10	6,50
815091405 22	5	22	M5	SW2,5	10	6,80
815091406 26	6	26	M6	SW3	5	8,30
815091408 28	8	28	M8	SW4	5	10,00

Spannschlösser, Terminals und Drahtseile

Turnbuckles, terminals and wire ropes

Tendeurs, ridoirs, embouts à sertir et câbles

2

NEW

Kugel-Klemmstopper, poliert / A4-AISI 316
Wire rope ball stopper, polished / Butée de boule de câble, surface poli

815092

Artikel-Nr. Item-no.	DS-Ø WR-Ø	D	GW	Antrieb Drive	Box	*€/Stück *€/piece
815092403 15	3	15	M4	SW2	10	6,20
815092404 20	4	20	M5	SW2,5	10	7,10
815092405 22	5	22	M5	SW2,5	10	7,80
815092406 26	6	26	M6	SW3	5	9,50
815092408 28	8	28	M8	SW4	5	11,10

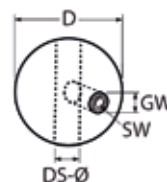

2

Klemmring 2-tlg. mit 2 Schrauben / A4-AISI 316
2-part clamping ring with 2 screws / Bague d'arrêt pour câble, 2 parties (2 vis)

814700

Artikel-Nr. Item-no.	DS-Ø WR-Ø	GW	L	D	Antrieb Drive	Box	*€/Stück *€/piece
814700402	2	M3	10	15	SW2,5	10	3,30
814700403	3	M3	10	15	SW2,5	10	3,80
814700404	4	M3	10	15	SW2,5	10	3,90
814700405	5	M3	10	20	SW2,5	10	4,10
814700406	6	M3	10	20	SW2,5	10	4,20
814700408	8	M4	12	20	SW3	10	4,60

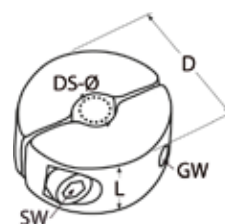

Klemmring 2-tlg. mit 4 Schrauben / A4-AISI 316
2-part clamping ring with 4 screws / Bague d'arrêt pour câble, 2 parties (4 vis)

814701

Artikel-Nr. Item-no.	DS-Ø WR-Ø	GW	L	D	Antrieb Drive	Box	*€/Stück *€/piece
814701403	3	M4	27	22	SW3	10	8,40
814701404	4	M4	27	22	SW3	10	8,50
814701405	5	M5	42	28	SW4	5	17,50
814701406	6	M5	42	28	SW4	5	17,70
814701408	8	M5	42	28	SW4	5	17,90

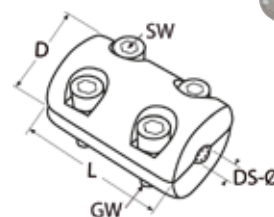

Spannschlösser, Terminals und Drahtseile

Turnbuckles, terminals and wire ropes

Tendeurs, ridoirs, embouts à sertir et câbles

8470

Pressklemme Edelstahl / A4-AISI 316

Stainless steel ferrule / Manchon en inox

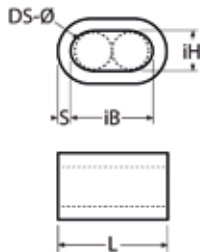

Artikel-Nr. Item-no.	DS-Ø WR-Ø	Klemmgröße Crimp size	iH	iB	S	L	Box	*€/Stück *€/piece
8470401	1,0	1,0	1,2	2,4	0,65	5	50	1,40
84704015	1,5	1,5	1,7	3,4	0,85	6	50	1,60
8470402	2,0	2,0	2,5	4,5	1,0	7	50	1,80
84704025	2,5	2,5	2,7	5,4	1,0	9	50	2,00
8470403	3,0	3,0	3,5	7,5	1,0	11	50	2,20
8470404	4,0	4,0	4,5	9,2	1,5	14	50	2,60
8470405	5,0	5,0	5,6	11,5	2,0	18	25	4,00
8470406	6,0	6,0	6,8	13,5	2,5	21	25	5,50
8470407	7,0	7,0	8,0	16,5	2,5	25	10	12,90
8470408	8,0	8,0	9,0	18,0	3,0	28	10	7,50
8470410	10,0	10,0	11,5	22,5	3,2	35	10	10,80
8470412	12,0	12,0	14,2	28,5	4,0	42	10	14,40

8285

Pressklemme Kupfer / CU

Copper ferrule / Manchon en cuivre

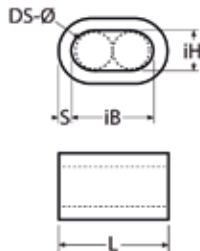

Artikel-Nr. Item-no.	DS-Ø WR-Ø	Klemmgröße Crimp size	iH	iB	S	L	Box	*€/Stück *€/piece
8285101	1,0	1,5	1,7	3,4	0,75	6	250	0,18
82851015	1,5	2,0	2,4	4,8	0,85	7	250	0,24
8285102	2,0	2,5	2,7	5,4	1,05	9	250	0,30
82851025	2,5	3,0	3,3	6,6	1,25	11	250	0,40
8285103	3,0	3,5	3,8	7,6	1,5	13	250	0,60
8285104	4,0	4,5	4,9	9,8	1,9	16	100	1,00
8285105	5,0	6,0	6,6	13,2	2,5	21	50	2,10
8285106	6,0	6,5	7,2	14,4	2,7	23	50	3,50
8285107	7,0	8,0	8,8	17,6	3,3	28	10	5,20
8285108	8,0	9,0	9,9	19,8	3,7	32	10	7,60
8285110	10,0	11,0	12,1	24,2	4,5	39	10	13,70
8285112	12,0	13,0	14,2	28,4	5,4	46	10	26,20
8285116	16,0	18,0	19,6	39,2	7,6	63	5	52,50

Spannschlösser, Terminals und Drahtseile

Turnbuckles, terminals and wire ropes

Tendeurs, ridoirs, embouts à sertir et câbles

2

Pressklemme Kupfer verzinkt / Cu vz

Copper ferrule tinned / Manchon en cuivre étamé

8285

Artikel-Nr. Item-no.	DS-Ø WR-Ø	Klemmgröße Crimp size	iH	iB	S	L	Box	*€/Stück *€/piece
8285101VZ	1,0	1,5	1,7	3,4	0,75	6	250	0,24
82851015VZ	1,5	2,0	2,4	4,8	0,85	7	250	0,30
8285102VZ	2,0	2,5	2,7	5,4	1,05	9	250	0,32
8285103VZ	3,0	3,5	3,8	7,6	1,5	13	250	0,90
8285104VZ	4,0	4,5	4,9	9,8	1,9	16	100	1,80
8285105VZ	5,0	6,0	6,6	13,2	2,5	21	50	2,50
8285106VZ	6,0	6,5	7,2	14,4	2,7	23	50	4,80
8285108VZ	8,0	9,0	9,9	19,8	3,7	32	10	9,20

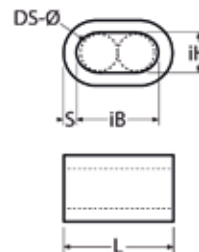

Kupfer-Pressklemmen mit einer verzinnnten Oberflächenbeschichtung sehen in Verbindung mit silbernem Drahtseil oder anhängenden Beschlägen nicht nur optisch ansprechender aus (auch nach der Verarbeitung!). Die Beschichtung bewirkt einen zusätzlichen Korrosionsschutz und verhindert die nachträgliche Bildung einer grünlichen Patina bzw. Passivschicht des Kupfers nach Berührung mit leicht aggressiven Laugen und Säuren.

Copper ferrules with a tinned coating in combination with silver wire rope or fittings are not only visually looking better (even after processing!). The coating additionally prevents the formation of green patina or passive layer of the copper in contact with lower aggressive alkalis or acids.

Les manchons en cuivre avec revêtement superficiel étamé sont très attrayants en conjonction avec un câble inox argenté ou des raccords (même après la fabrication). Également, le revêtement offre une protection anticorrosion et empêche la formation d'une patine verdâtre ultérieure ou bien d'une couche passive de cuivre au contact d'alcalins et d'acides légèrement agressifs.

Pressklemme Aluminium / Alu

Alu ferrule / Manchon en alu

8471

Artikel-Nr. Item-no.	DS-Ø WR-Ø	Klemmgröße Crimp size	iH	iB	S	L	Box	*€/Stück *€/piece
8471001	1,0	1,5	1,7	3,4	0,75	6	500	0,08
84710015	1,5	2,0	2,4	4,8	0,85	7	500	0,10
8471002	2,0	2,5	2,7	5,4	1,05	9	500	0,12
84710025	2,5	3,0	3,3	6,6	1,25	11	500	0,14
8471003	3,0	3,5	3,8	7,6	1,5	13	250	0,16
8471004	4,0	4,5	4,9	9,8	1,9	16	250	0,26
8471005	5,0	6,0	6,6	13,2	2,5	21	100	0,40
8471006	6,0	6,5	7,2	14,4	2,7	23	100	0,50
8471007	7,0	8,0	8,8	17,6	3,3	28	100	0,70
8471008	8,0	9,0	9,9	19,8	3,7	32	50	1,50
8471010	10,0	11,0	12,1	24,2	4,5	39	25	1,70
8471012	12,0	13,0	14,2	28,4	5,4	46	25	2,60

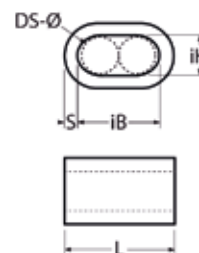

Nicht empfohlen für die Verarbeitung mit Drahtseilen aus Edelstahl.

Not recommended for processing with wire ropes made of stainless steel.

Non recommandé pour le traitement avec des câbles en acier inoxydable.

2

Spannschlösser, Terminals und Drahtseile

Turnbuckles, terminals and wire ropes

Tendeurs, ridoirs, embouts à sertir et câbles



815001

Drahtseilklemme mit Auge, MT-Serie / A4-AISI 316

Wire rope clip with eye, MT series / Serre-câbles avec œil, Série MT

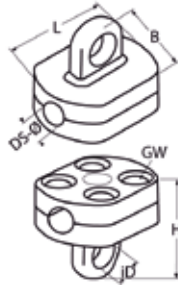

NEW

Artikel-Nr. Item-no.	DS-Ø WR-Ø	L	B	H	iD	GW	Box	*€/Stück *€/piece
815001406	6	45	35	39	12	M5	1	27,00
815001408	8	45	35	39	12	M5	1	27,00
815001410	10	45	35	39	12	M5	1	27,00



815002

Drahtseilklampe, MT-Serie / A4-AISI 316

Cleat for wire rope, MT series / Taquet pour câble, Série MT

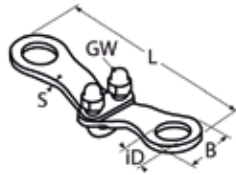

Artikel-Nr. Item-no.	DS-Ø WR-Ø	L	B	iD	S	GW	Box	*€/Stück *€/piece
8150024110	8+10	110	30	16	3	M6	1	6,50

8279

Steckbolzen / A4-AISI 316

Clevis pin / Axe pour ridoir

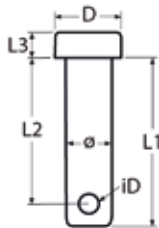

NEW

NEW

Artikel-Nr. Item-no.	ø	L1	L2	L3	D	iD	Box	*€/Stück *€/piece
8279404 14	4,0	14	11,0	2,0	6	2,0	50	1,10
8279404 20	4,0	20	16,0	2,0	6	2,0	50	1,10
8279405 15	5,0	15	11,0	2,0	8	2,5	50	1,20
8279405 18	5,0	18	14,0	2,0	8	2,5	50	1,20
8279405 19	5,0	19	15,0	2,0	8	2,5	50	1,20
8279405 21	5,0	21	17,0	2,0	8	2,5	50	1,30
8279406 15	6,0	15	11,0	2,0	10	2,5	50	1,40
8279406 19	6,0	19	15,0	2,0	10	2,5	50	1,50
8279406 20	6,0	20	16,0	2,0	10	2,5	50	1,60
8279406 24	6,0	24	20,0	2,0	10	2,5	50	1,70
8279406 25	6,0	25	21,0	2,0	10	2,5	50	1,70
8279406 29	6,0	29	25,0	2,0	10	2,5	50	1,80
8279406 34	6,0	34	30,0	2,0	10	2,5	50	1,90
8279406 36	6,0	36	32,0	2,0	10	2,5	50	1,90
8279406 44	6,0	44	40,0	2,0	10	2,5	50	2,00

Spannschlösser, Terminals und Drahtseile

Turnbuckles, terminals and wire ropes

Tendeurs, ridoirs, embouts à sertir et câbles

2

Steckbolzen / A4-AISI 316
Clevis pin / Axe pour ridoir

8279

Artikel-Nr. Item-no.	ø	L1	L2	L3	D	iD	Box	*€/Stück *€/piece
8279406 45	6,0	45	41,0	2,0	10	2,5	50	2,00
8279406 54	6,0	54	50,0	2,0	10	2,5	50	2,10
8279406 64	6,0	64	60,0	2,0	10	2,5	50	2,20
8279408 21	8,0	21	17,0	2,5	12	3,0	25	2,30
8279408 22	8,0	22	18,5	2,5	12	3,0	25	2,30
8279408 24	8,0	24	20,0	2,5	12	3,0	25	2,40
8279408 25	8,0	25	21,0	2,5	12	3,0	25	2,40
8279408 27	8,0	27	23,0	2,5	12	3,0	25	2,40
8279408 32	8,0	32	28,0	2,5	12	3,0	25	2,50
8279408 34	8,0	34	30,0	2,5	12	3,0	25	2,60
8279408 44	8,0	44	40,0	2,5	12	3,0	25	2,60
8279408 54	8,0	54	50,0	2,5	12	3,0	25	2,70
8279408 64	8,0	64	60,0	2,5	12	3,0	25	2,70
8279408 74	8,0	74	70,0	2,5	12	3,0	25	2,80
8279408 84	8,0	84	80,0	2,5	12	3,0	25	2,90
8279409 25	9,0	25	21,5	2,5	12	3,0	25	2,90
8279409 28	9,0	28	24,0	2,5	12	3,0	25	2,90
82794095 26	9,5	26	22,0	2,5	13	3,0	25	2,90
82794095 30	9,5	30	26,0	2,5	13	3,0	25	3,00
8279410 26	10,0	26	22,0	2,5	14	3,0	25	3,10
8279410 34	10,0	34	30,0	2,5	14	3,0	25	3,10
8279410 44	10,0	44	40,0	2,5	14	3,0	25	3,20
8279410 54	10,0	54	50,0	2,5	14	3,0	25	3,20
8279410 64	10,0	64	60,0	2,5	14	3,0	25	3,50
8279410 74	10,0	74	70,0	2,5	14	3,0	25	3,60
8279410 84	10,0	84	80,0	2,5	14	3,0	25	3,80
8279410 94	10,0	94	90,0	2,5	14	3,0	25	3,90
8279410 104	10,0	104	100,0	2,5	14	3,0	25	4,20
8279411 29	11,0	29	25,0	3,0	16	3,0	10	5,20
8279412 30	12,0	30	26,0	3,0	16	3,0	10	5,30
8279412 32	12,0	32	28,0	3,0	16	3,0	10	5,30
8279412 45	12,0	45	40,0	3,0	16	3,0	10	5,40
8279412 55	12,0	55	50,0	3,0	16	3,0	10	5,60
8279412 65	12,0	65	60,0	3,0	16	3,0	10	5,80
8279412 75	12,0	75	70,0	3,0	16	3,0	10	5,90
8279412 85	12,0	85	80,0	3,0	16	3,0	10	6,00
8279412 95	12,0	95	90,0	3,0	16	3,0	10	6,10
8279412 105	12,0	105	100,0	3,0	16	3,0	10	6,40
8279412 115	12,0	115	110,0	3,0	16	3,0	10	6,50
8279412 125	12,0	125	120,0	3,0	16	3,0	10	6,70
8279414 41	14,0	41	36,0	3,0	18	4,0	10	6,80
8279416 36	16,0	36	31,0	4,0	21	4,0	10	7,00
8279416 41	16,0	41	36,0	4,0	21	4,0	10	7,10

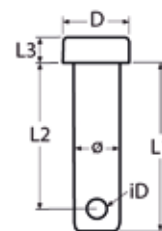

NEW

NEW

NEW

NEW

NEW

NEW

NEW

NEW

2

Spannschlösser, Terminals und Drahtseile

Turnbuckles, terminals and wire ropes

Tendeurs, ridoirs, embouts à sertir et câbles

8356

Klappnasenbolzen / A2-AISI 304

Drop nose pin / Axe pour ridoir avec languette



Artikel-Nr. Item-no.	ø	L	L1	Box	*€/Stück *€/piece
8356206 20	6	20	12	10	6,00
8356206 26	6	26	18	10	6,50
8356206 31	6	31	23	10	7,00
8356206 56	6	56	48	10	8,00
8356206 65	6	65	57	10	9,00
8356208 28	8	28	20	10	7,00
8356208 34	8	34	25	10	7,50
8356208 38	8	38	30	10	8,00
8356208 43	8	43	35	10	8,50
8356210 35	10	35	25	10	9,00
8356210 45	10	45	35	10	9,50
8356210 55	10	55	45	10	10,00

815014

Klappnasenbolzen, MT-Serie, made in Germany / A5-AISI 316 Ti

Drop nose pin, MT series / Axe pour ridoir avec languette, Série MT

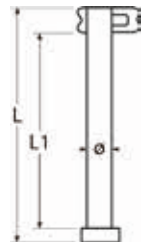

Artikel-Nr. Item-no.	ø	L	L1	Box	*€/Stück *€/piece
815014406 20	6	20	12	5	13,00
815014406 26	6	26	18	5	13,30
815014406 31	6	31	23	5	13,60
815014406 56	6	56	48	5	14,40
815014406 65	6	65	57	5	15,10
815014408 30	8	30	20	2	14,00
815014408 35	8	35	25	2	14,30
815014408 40	8	40	30	2	14,60
815014408 45	8	45	35	2	15,00
815014410 37	10	37	25	1	16,50
815014410 47	10	47	35	1	17,50
815014410 57	10	57	45	1	18,90

Spannschlösser, Terminals und Drahtseile

Turnbuckles, terminals and wire ropes
Tendeurs, ridoirs, embouts à sertir et câbles

2

Steckbolzen mit Kugelsicherung / A2-AISI 304

Pin with ball lock / Goupille à bille

8474

Artikel-Nr. Item-no.	ø	L	L1	Box	*€/Stück *€/piece
847425 28	5,0	28	13	25	3,50
847426 35	6,3	35	22	25	3,70
847426 42	6,3	42	31	25	6,10
847428 33	8,0	33	22	25	5,00
847428 53	8,0	53	38	25	5,70

NEW



Steckbolzen mit manueller Kugelsicherung / A1-AISI 303

Quick release pin with manual ball lock / Goupille à bille manuelle

814729

Artikel-Nr. Item-no.	ø	L	L1	D	Box	*€/Stück *€/piece
814729206 25	6	55	25	20	1	55,60
814729206 40	6	70	40	20	1	58,70
814729208 25	8	55	25	20	1	58,90
814729208 40	8	70	40	20	1	59,10
814729210 25	10	60	25	25	1	59,90
814729210 40	10	75	40	25	1	64,30



Klappsplint mit Ring / A4-AISI 316

Linch pin / Goupille clip

814076

Artikel-Nr. Item-no.	ø	ø1	L	L1	iD	Box	*€/Stück *€/piece
8140764440	4,4	2,4	49,6	35	39,0	25	3,00
8140764600	6,0	3,2	56,2	39	44,8	25	3,50
8140764790	7,4	3,1	56,5	39	44,9	10	5,70
8140764106	10,6	3,2	56,5	39	43,4	10	7,40

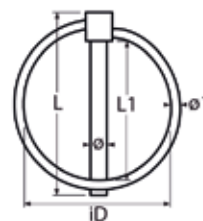

Federstecker / A4-AISI 316

Spring cotter / Goupille beta

8273

Artikel-Nr. Item-no.	ø	L	Box	*€/Stück *€/piece
827342	2,0	49	250	0,40
8273425	2,5	55	250	0,60
827343	3,0	70	250	0,80
827344	4,0	79	100	1,40
827345	5,0	101	50	2,50
827346	6,0	126	50	3,30

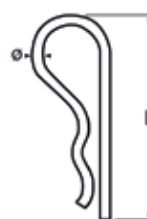

2

Spannschlösser, Terminals und Drahtseile

Turnbuckles, terminals and wire ropes

Tendeurs, ridoirs, embouts à sertir et câbles

8431

Federstecker ähnl. DIN 11024 / A4-AISI 316

Spring cotter similar to DIN 11024 / Goupille beta double similaire à DIN 11024

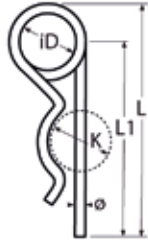

Artikel-Nr. Item-no.	ø	L	L1	iD	K	Box	*€/Stück *€/piece
8431425	2,25	54	42	20	9-11	50	2,20
8431432	2,8	61	48	20	11-14	50	3,50
8431440	3,6	78	64	20	14-20	25	4,20
8431450	4,5	97	80	25	20-26	25	5,20
8431463	5,6	115	97	25	26-34	25	6,50
8431470	6,3	146	125	30	34-45	10	7,80
8431480	7,0	169	150	30	45-56	10	9,90

814911

Fokkernadel / A4-AISI 316

Safety spring / Épingle de sécurité

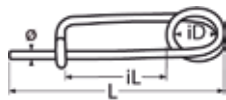

Artikel-Nr. Item-no.	ø	L	iL	iD	Box	*€/Stück *€/piece
814911402	2	60	32	12	50	1,00
814911403	3	80	40	16	50	2,00
814911404	4	100	48	20	50	3,00

8383

Ringsplint / A4-AISI 316

Ring pin / Anneau brisé

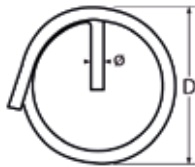

Artikel-Nr. Item-no.	ø	D	Für Steckbolzen-Ø For clevis pin-Ø	Box	*€/Stück *€/piece
8383410 10	1,0	11	4	250	0,10
NEW 8383412 13	1,2	13	4-6	250	0,15
8383412 15	1,2	15	5-6	250	0,15
NEW 8383415 18	1,5	18	8	250	0,20
8383415 20	1,5	20	8-10	250	0,20
NEW 8383415 25	1,5	25	12	250	0,25
8383418 25	1,8	25	11-14	250	0,25
NEW 8383420 30	2,0	30	16	250	0,30

8358

Sicherungsring / A2-AISI 304

Cotter ring / Anneau de sécurité



Artikel-Nr. Item-no.	ø	D	Box	*€/Stück *€/piece
8358210	1,5	10	250	0,20
8358216	1,5	16	250	0,25
8358218	1,5	18	250	0,30
8358222	1,5	22	250	0,35
8358226	1,5	26	250	0,40
8358230	1,5	30	250	0,45

Spannschlösser, Terminals und Drahtseile

Turnbuckles, terminals and wire ropes
Tendeurs, ridoirs, embouts à sertir et câbles

2

Sicherungsseil PVC transparent ummantelt / A2-AISI 304 / PVC Security wire rope PVC clear coated / Câble de sécurité

8719

Artikel-Nr. Item-no.	DS-Ø WR-Ø	L	iD	iD1	Box	*€/Stück *€/piece
87192200	1,2	145	5,4	8	10	3,00

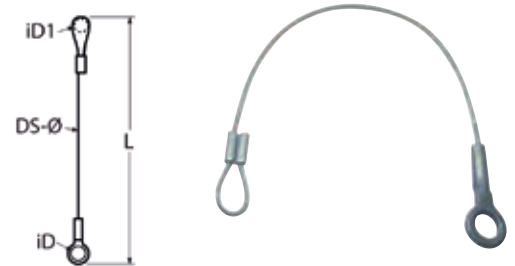

2

Sicherungsseil mit Steckbolzen / A2-AISI 304 Security wire with ball lock pin / Câble de sécurité avec goupille à bille

8590

Artikel-Nr. Item-no.	DS-Ø WR-Ø	ø	L	B	S	BD	Box	*€/Stück *€/piece
859026 25	1,0	6,3	250	13	1,5	5,2	10	9,00

Länge kann um +/- 20% variieren.

Length can vary +/- 20%.

La longueur peut varier +/- 20%.



Sicherungsseil mit Klappnasenbolzen / A2-AISI 304 Security wire with drop nose pin / Câble de sécurité avec axe à languette

814996

Artikel-Nr. Item-no.	DS-Ø WR-Ø	ø	L	B	S	BD	Box	*€/Stück *€/piece
8149964255	1,0	6	255	13	1,2	5	10	5,30



Drahtseilschere / Stahl gehärtet Wire rope cutter / Cisaille pour câble

8504

Artikel-Nr. Item-no.	DS-Ø WR-Ø	L	Box	*€/Stück *€/piece
85041004	4*	195	1	28,50
85041012	12	470	1	265,00
85041016	16	800	1	630,00
850410ERSATZ12	Ersatzmesser für 12 / Replacement blade for 12		1	180,00
850410ERSATZ16	Ersatzmesser für 16 / Replacement blade for 16		1	250,00

* max. 4mm 7x19 + 7x7

max. 3mm 1x19



850410ERSATZ12
850410ERSATZ16



85041004



85041012 + 85041016

2

Spannschlösser, Terminals und Drahtseile

Turnbuckles, terminals and wire ropes

Tendeurs, ridoirs, embouts à sertir et câbles

814678

Hydraulische Presszange, 7t / Stahl

Hydraulic crimping tool 7t / Pince hydraulique à sertissage manuel

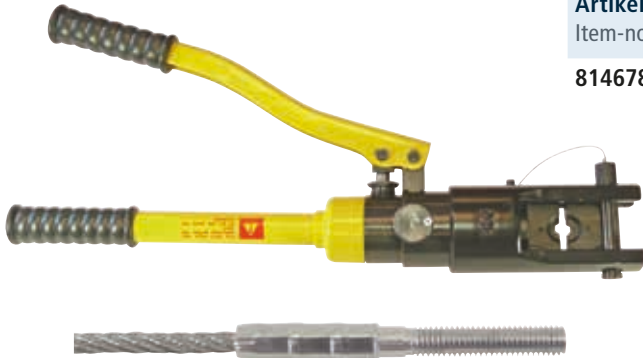

Artikel-Nr. Item-no.	Max. Presskraft Max. pressing force	L	Box	*€/Stück *€/piece
8146781012	7 Tonnen / 7 tons	480	1	200,00

Mit einer Kraft von 7 Tonnen und einer Werkzeugbreite von 12mm ist die hydraulische Presszange optimal geeignet um Terminals und Oval-Presshülsen schnell und kostengünstig direkt vor Ort zu verpressen. Lieferung im Kunststoffkoffer ohne Presseinsätze.

With a force of 7 tons and a width of 12mm, the hydraulic crimping tool is ideally suited for quickly and inexpensively crimping for terminals and ferrules directly on site. Supplied in a plastic case without crimping dies.

Avec une force de 7 tonnes et une largeur d'outil de 12mm, la pince hydrolique convient parfaitement aux terminaisons et manchons pour presser rapidement et à moindre coût directement sur place. Livraison en coffret plastique sans machoirs.

814679

Pressbacken für Terminals / Stahl gehärtet

Dies for terminal crimping / Machoir pour terminaison



Artikel-Nr. Item-no.	DS-Ø WR-Ø	Terminal Außen-Ø Terminal outside-Ø	Pressbreite Pressing width	Box	*€/Stück *€/piece
81467912-02	2,0	4,8	8,0	1	150,00
81467912-025	2,5	5,5	8,0	1	150,00
81467912-03	3,0	6,4	8,0	1	150,00
81467912-04	4,0	7,5	6,0	1	150,00
81467912-05	5,0	9,0	6,0	1	150,00
81467912-06	6,0	12,5	4,7	1	150,00

Für Artikel 814678 - Hydraulische Presszange
Gefertigt aus hochwertigem Werkzeugstahl
mit optimaler Härte und Zähigkeit. Qualität
made in Germany gewährleistet maximale
Lebensdauer.

For article 814678 - Hydraulic crimping tool
Made from high quality tool steel with opti-
mum hardness and toughness. Quality made
in Germany ensures maximum durability.

Pour article 814678 - Pince hydraulique à sertissage manuel
Fabriqué en acier à outils de haute qualité avec une dureté et
une ténacité optimales. La qualité made in Germany garantit
une durée de vie maximale.

814810

Pressbacken für Oval-Pressklemmen / Stahl gehärtet

Dies for oval-ferrules crimping / Machoirs pour manchon ovale



Abb. 81481012-01

Abb. 81481012-025
Abb. 81481012-04

AAbb. 81481012-05

Artikel-Nr. Item-no.	DS-Ø WR-Ø	Pressbreite Pressing width	Box	*€/Stück *€/piece
81481012-01	1,0 / 1,5 / 2,0	12	1	300,00
81481012-025	2,5	12	1	200,00
81481012-03	3,0	12	1	200,00
81481012-04	4,0	12	1	200,00
81481012-05	5,0	4	1	200,00

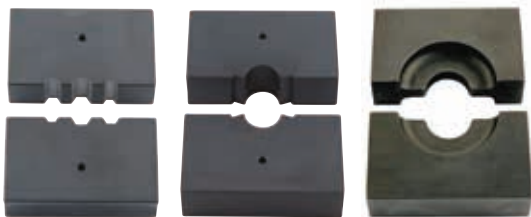
Für Hydraulische Presszange
Drahtseildurchmesser (DS-Ø)
gültig für Drahtseile mit Stahllein-
lage (SE). Nicht für Pressklemmen
aus Edelstahl geeignet.

For Hydraulic crimping tool
Wire rope diameter (DS-Ø) only for
wire ropes with wire core (WC).
Not usable for stainless steel ferrules.

Pour Pince hydraulique à sertissage manuel
Diamètre de câble (DS-Ø) valable pour les
câbles avec âme en acier.
Ne convient pas pour les manchons en acier
inoxydable.

Spannschlösser, Terminals und Drahtseile

Turnbuckles, terminals and wire ropes
Tendeurs, ridoirs, embouts à sertir et câbles

2

Massivkugel mit Innengewinde, blank / A2-AISI 304

Massive ball with internal thread, machined / Boule massive mate avec filetage interne

8462

Artikel-Nr. Item-no.	GW	iL	D	Box	*€/Stück *€/piece
8462215	M6	6	15	10	8,00
8462220	M6	17	20	10	6,30
8462225	M6	17	25	10	9,90
8462230	M6	18	30	10	15,00
8462240	M8	24	40	5	25,00
8462250	M8	24	50	5	39,90

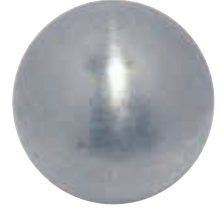
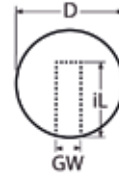

2

Kombi-Wandkonsole / A4-AISI 316

Combi wall bracket / Support mural

8499

Artikel-Nr. Item-no.	GW	A	B	BD	H1	H2	H3	D	iD	iD1	S	Box	*€/Stück *€/piece
84994A135 90	M4	135	25	10	90	69	14	16	8	8	4	1	25,00
84994B135 90	–	135	25	10	90	–	–	–	9	–	4	1	25,00
84994A136 124	M4	136	24	10	124	85	30	16	8	8	4	1	27,00
84994A136 124	–	136	24	10	124	–	–	–	8	–	4	1	27,00

NEW
NEW

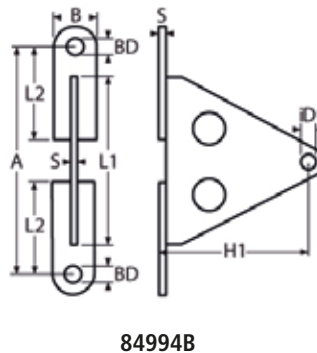
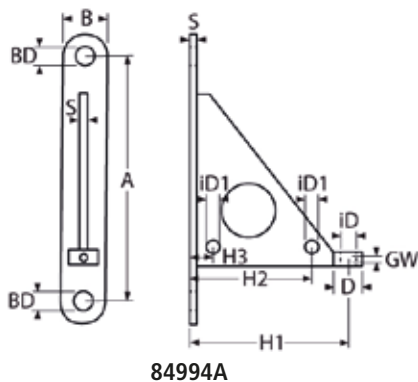



Druckknopfsysteme

Snap fastening systems

Système de bouton à pression

Kapitel 3

Chapter 3



Sperrverschluß System
Self-locking fastener system
Système de verrouillage



**Lift-The-DOT
Druckknopfsystem**
Lift-The-DOT snap fasteners
Boutons-pression Lift-The-DOT



Minax-Verschlußsystem
Minax-quick fasteners
Boutons Minax



**DOT-Common-Sense
Drehverschlüsse**
DOT-Common-Sense
turn-lock fasteners
Fixation tournant DOT-
Common-Sense



**Durable-DOT
Druckknopfsystem**
Durable-DOT snap fasteners
Boutons-pression Durable-DOT



**Ösen +
Paneelbefestigungen**
Eyelets and Panel Clips
Oeillets et clips de panneau

815095

Tenax Oberteil, großer Knopf
 Tenax upper part, big knob / Bouton Tenax partie supérieure

NEW



Artikel-Nr. Item-no.	Gewindelänge Length of thread	Ausführung Type	Box	*€/Stück *€/piece
8150952GROSS	4,9	Edelstahl A2 Stainless steel A2 Acier inox A2	50	4,00
8150956GROSS	4,9	Messing vernickelt Brass, nickel plated Laiton nickelé	50	3,20
8150956GROSSXL	6,9	Messing vernickelt Brass, nickel plated Laiton nickelé	50	3,70
8150957GROSS	4,9	Messing verchromt Brass, chrome plated Laiton chromé	50	3,80
8150957GROSS-SCHWARZ	4,9	Messing schwarz verchromt Brass, chrome plated black Laiton chromé noir	50	4,40

Werkzeug: 815097 und 816003 / Tool: 815097 and 816003 / Outil: 815097 et 816003

816000

Tenax-Knopf Oberteil mit Ring
 Tenax knob upper part with ring / Bouton Tenax avec bague

NEW



Artikel-Nr. Item-no.	Gewindelänge Length of thread	Ausführung Type	Box	*€/Stück *€/piece
8160006R	4,9	Messing vernickelt Brass, nickel plated Laiton nickelé	50	4,80
8160007RS	4,9	Messing schwarz verchromt Brass, chrome plated black Laiton chromé noir	50	5,20

Werkzeug: 815097 und 816003 / Tool: 815097 and 816003 / Outil: 815097 et 816003

815096

Tenax Stoffunterteil
 Tenax lower part for fabric / Bouton Tenax partie inférieure pour tissu

NEW



Artikel-Nr. Item-no.	Ausführung Type	Box	*€/Stück *€/piece
8150966STOFFE	Messing vernickelt Brass, nickel plated Laiton nickelé	50	1,90

Werkzeug: 815097 und 816003 / Tool: 815097 and 816003 / Outil: 815097 et 816003

GHE TENAX®

Blechschaube für Tenax-Knopf
Tapping screw for Tenax-knob / Vis à tôle pour bouton Tenax

815098

NEW

Artikel-Nr. Item-no.	GW	L1	Ausführung Type	Antrieb Drive	Box	*€/Stück *€/piece
815098242 10	4,2	10	Edelstahl A2 Stainless steel A2 Acier inox A2	SW9	50	3,10
815098242 12	4,2	12	Edelstahl A2 Stainless steel A2 Acier inox A2	SW9	50	3,20
815098242 16	4,2	16	Edelstahl A2 Stainless steel A2 Acier inox A2	SW9	50	3,40



GHE TENAX®

Metrische Schraube für Tenax-Knopf
Tapping screw for Tenax-knob / Vis à tôle pour bouton Tenax

815099

NEW

Artikel-Nr. Item-no.	GW	L1	Ausführung Type	Antrieb Drive	Box	*€/Stück *€/piece
815099210	M5	10	Edelstahl A2 Stainless steel A2 Acier inox A2	SW9	50	2,30
815099610VERN	M5	10	Messing vernickelt Brass, nickel plated Laiton nikkélé	SW9	50	2,10
815099710VERC	M5	10	Messing verchromt Brass, chrome plated Laiton chromé	SW9	50	2,20
815099710VER-SCHWARZ	M5	10	Messing schwarz verchromt Brass, chrome plated black Laiton chromé noir	SW9	50	2,70



GHE TENAX®

Tenax Unterteil zum Verschrauben
Tenax lower part for screw fixing / Bouton Tenax plaquette partie inférieure à visser

816002

NEW

Artikel-Nr. Item-no.	L	B	H	A	BD	Ausführung Type	Box	*€/Stück *€/piece
816002727 11	27	11	9	15,1	4,9	Messing verchromt Brass, chrome plated Laiton chromé	50	1,70
816002727 11SCHWARZ	27	11	9	15,1	4,9	Messing schwarz verchromt Brass, chrome plated black Laiton chromé noir	50	2,00

Passend für Linsensenk-Blechschauben DIN 7983, ISO 14587 3,5mm oder Linsensenk-Holzschrauben DIN 7995 3,5mm.

For countersunk tapping screws DIN 7983, ISO 14587 3.5mm or countersunk wood screws DIN 7995 3.5mm.

Approprié pour les vis à tête fraisée bombée DIN 7983, ISO 14587 3,5mm ou vis à bois à tête fraisée DIN 7995 3,5mm.

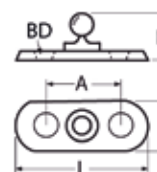

816001

Tenax Unterteil Rundplatte / A2-AISI 304
Tenax stud with round plate / Bouton Tenax plaquette ronde partie inférieure

GHE TENAX®

NEW

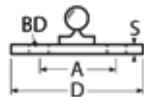

Artikel-Nr. Item-no.	D	S	A	BD	Ausführung Type	Box	*€/Stück *€/piece
816001224S	24	1,6	16	4,6	Zum Verschrauben For screw fixing Pour visser	50	5,60
816001224K	24	1,6	–	–	Zum Verkleben For glue fixing Pour coller	50	4,80

815097

Tenax Schlüssel aus Stahlblech / Stahl vernickelt
Tenax small key / Clé pour Tenax

GHE TENAX®

NEW



Artikel-Nr. Item-no.	L	Antrieb Drive	Box	*€/Stück *€/piece
815097210	32	SW9	10	0,60

816003

Tenax Schlüssel mit Holzgriff
Tenax key with wood handle / Clé pour Tenax avec manche en bois

GHE TENAX®

NEW



Artikel-Nr. Item-no.	L	Box	*€/Stück *€/piece
81600310140	140	1	30,00

8667

Blechschaube für Druckknopf
Tapping screw for snap fastener / Vis à tôle pour fermeture de sécurité

GHE TENAX®



Artikel-Nr. Item-no.	GW	L1	Ausführung Type	Antrieb Drive	Box	*€/Stück *€/piece
8667242 10	4,2	10	Edelstahl A2 ¹	SW9	50	1,00
8667242 12	4,2	12	Edelstahl A2 ¹	SW9	50	1,10
8667242 16	4,2	16	Edelstahl A2 ¹	SW9	50	1,30

¹Stainless steel A2 / Acier inox A2

Druckknopfsysteme

Snap fastening systems

Système de bouton à pression

3

Metrische Schraube für Druckknopf

Metric screw for snap fastener / Vis métrique pour fermeture de sécurité

8696

Artikel-Nr. Item-no.	GW	L1	Ausführung Type	Antrieb Drive	Box	*€/Stück *€/piece
8696210	M5	10	Edelstahl A2 ²	SW8	50	1,50

¹Brass, nickel plated / Laiton nickelé

²Stainless steel A2 / Acier inox A2

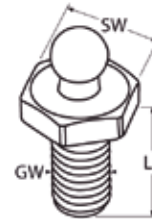

3

Minax Oberteil / Plastik

Minax upper part / Bouton Minax partie femelle en

814411

Artikel-Nr. Item-no.	D	Box	*€/Stück *€/piece
814411323 11	23	100	2,00

Stoff 14mm vorstanzen
Textile punch hole 14mm
Tissu 14mm pré-découpe



NEW

Minax Schlüssel / Stahl

Minax key / Clé pour Minax

816013

Artikel-Nr. Item-no.	L	Ausführung Type	Box	*€/Stück *€/piece
81601310	115	Für Ober- und Unterteile For upper and bottom parts Pour partie mâle et femelle	1	38,00



Minax Unterteil / Plastik

Minax lower part / Bouton Minax partie mâle en

814412

Artikel-Nr. Item-no.	D	Box	*€/Stück *€/piece
814412323	23	100	1,40

Stoff 14mm vorstanzen.
Textile punch hole 14mm.
Tissu 14mm pré-découpe.



3

Druckknopfsysteme Snap fastening systems Système de bouton à pression

814413

Minax Blechschaube mit TX-Antrieb / A2-AISI 304
Minax tapping screw TX-Drive / Bouton Minax partie mâle avec vis de empreinte TX

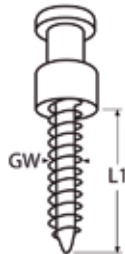

Artikel-Nr. Item-no.	GW	L1	Antrieb Drive	Box	*€/Stück *€/piece
814413235 25	3,5	14	TX10	100	2,00
814413235 32	3,5	22	TX10	100	2,10

814414

Minax Schraube für Polyester / Messing vernickelt
Minax screw for Polyester / Brass, nickel-plated / Bouton Minax partie mâle avec vis pour polyester / Laiton nickelé

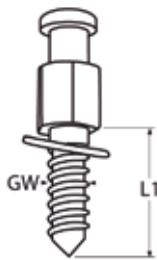

Artikel-Nr. Item-no.	GW	L1	Box	*€/Stück *€/piece
814414643 25	4,3	13	100	2,00

814415

Minax Schraube mit metrischen Gewinde / Messing vernickelt
Minax screw with metr. thread / Brass, nickel-plated / Bouton Minax partie mâle avec vis métrique / Laiton nickelé

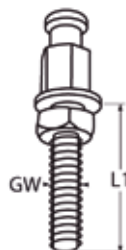

Artikel-Nr. Item-no.	GW	L1	Box	*€/Stück *€/piece
81441564 20	M4	8	100	1,80
81441564 24	M4	12	100	1,90
81441564 32	M4	20	100	2,00



Durable™ DOT® Kappe / Messing vernickelt

Durable™ DOT® cap, brass, nickel finish / Bouton Durable™-DOT® partie femelle - Laiton nickelé

814035

Artikel-Nr. Item-no.	D	L1	Box	*€/Stück *€/piece
814035615 44	15,2	4,7	100	0,30
814035615 61	15,2	6,2	100	0,40
814035615 80	15,2	8,0	100	0,60

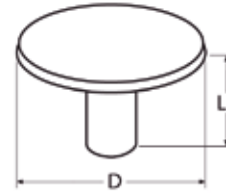

In Kombination mit Artikel 814036
In combination with article 814036
En combinaison avec l'article 814036



Durable™ DOT® Sockel / Messing vernickelt

Durable™ DOT® socket, brass, nickel finish / Bouton Durable™-DOT® partie femelle intermédiaire - Laiton nickelé

814036

Artikel-Nr. Item-no.	D	Box	*€/Stück *€/piece
814036615	15	100	0,30

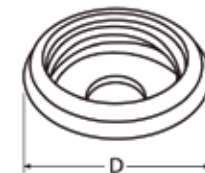

In Kombination mit Artikel 814035
In combination with article 814035
En combinaison avec l'article 814035.



Durable™ DOT® Zapfen / Messing vernickelt

Durable™ DOT® stud, brass, nickel finish / Bouton Durable™-DOT® partie mâle intermédiaire - Laiton nickelé

814037

Artikel-Nr. Item-no.	D	Box	*€/Stück *€/piece
814037615	14,1	100	0,30

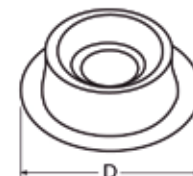

In Kombination mit Artikel 814038
In combination with article 814038
En combinaison avec l'article 814038



Durable™ DOT® Unterteil / Messing vernickelt

Durable™ DOT® post, brass, nickel finish / Bouton Durable™-DOT® partie mâle - Laiton nickelé

814038

Artikel-Nr. Item-no.	D	L1	Box	*€/Stück *€/piece
814038614 61	14,3	6,1	100	0,20
814038614 75	14,3	7,5	100	0,30
814038614 94	14,3	9,4	100	0,40

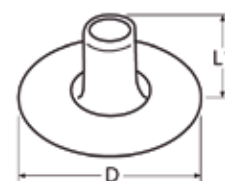

In Kombination mit Artikel 814037
In combination with article 814037
En combinaison avec l'article 814037

3

Druckknopfsysteme Snap fastening systems Système de bouton à pression

814760

Durable™ DOT® Kappe / A4-AISI 316
Durable™ DOT® cap / Bouton Durable™-DOT® partie femelle

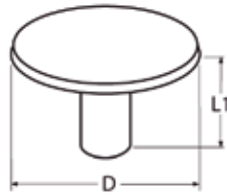

Artikel-Nr. Item-no.	D	L1	Box	*€/Stück *€/piece
814760415 44	15,2	4,4	100	0,50
814760415 64	15,2	6,4	100	0,60

In Kombination mit Artikel 814761
In combination with article 814761
En combinaison avec l'article 814761

814761

Durable™ DOT® Sockel / A4-AISI 316
Durable™ DOT® socket, brass, nickel finish / Bouton Durable™-DOT® partie femelle intermédiaire - Laiton nickelé

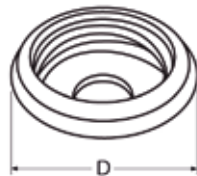

Artikel-Nr. Item-no.	D	Box	*€/Stück *€/piece
814761415	15	100	0,60

In Kombination mit Artikel 814760
In combination with article 814760
En combinaison avec l'article 814760

814762

Durable™ DOT® Zapfen / A4-AISI 316
Durable™ DOT® stud / Bouton Durable™-DOT® partie mâle intermédiaire

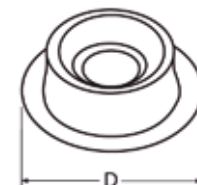

Artikel-Nr. Item-no.	D	Box	*€/Stück *€/piece
814762415	14,1	100	0,40

In Kombination mit Artikel 814763
In combination with article 814763
En combinaison avec l'article 814763

814763

Durable™ DOT® Unterteil / A4-AISI 316
Durable™ DOT® post / Bouton Durable™-DOT® partie mâle

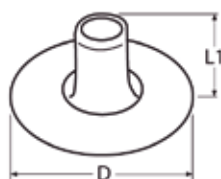

Artikel-Nr. Item-no.	L1	D	Box	*€/Stück *€/piece
814763414 64	6,4	14,3	100	0,30
814763414 79	7,9	14,3	100	0,40

In Kombination mit Artikel 814762
In combination with article 814762
En combinaison avec l'article 814762



Durable™ DOT® mit Bohrschraube, selbstschneidend / A2 / Messing vernickelt
Durable™ DOT® screw stud self drilling / A2 / brass, nickel finish / Bouton Durable-DOT® avec vis autoperceuse / A2 / Laiton nickelé

814040

Artikel-Nr. Item-no.	GW	L1	D	Box	*€/Stück *€/piece
814040615 095	4,1	11,1	15	100	1,40
814040615 159	4,1	15,9	15	100	1,60

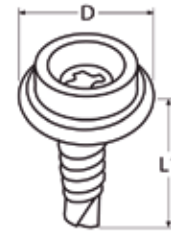

Zapfen Messing vernickelt. Schraube Edelstahl A2.
Stud part made of nickel plated brass. Screw made of stainless steel AISI 304.
Partie supérieure laiton nickelé. Vis inox A2.



Durable™ DOT® mit Bohrschraube / A2 / Messing vernickelt
Durable™ DOT® screw stud with self drilling screw / A2 / Brass, nickel finish / ***

814041

Artikel-Nr. Item-no.	GW	L1	D	Box	*€/Stück *€/piece
814041615 095	4,1	9,5	15	100	1,10
814041615 159	4,1	15,9	15	100	1,30



***Bouton Durable™-DOT® avec vis autoperceuse / A2 / Laiton nickelé
Zapfen Messing vernickelt. Schraube Edelstahl A2.
Stud made of nickel plated brass. Screw made of stainless steel AISI 304.
Bouton laiton nickelé. Vis inox A2.



Durable™ DOT® Unterteil für Windschutzscheiben / Messing vernickelt
Durable™ DOT® windshield clip, brass, nickel finish / Bouton Durable™-DOT® pour pare-brise - Laiton nickelé

814039

Artikel-Nr. Item-no.	iL	Box	*€/Stück *€/piece
814039634	19,1	100	1,50
814039678	22,2	100	1,70

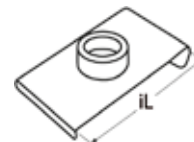

Lift-The-DOT® Sockel für Stoffe / Messing vernickelt
Lift-The-DOT® socket for textile, brass, nickel finish / Système Lift-The-DOT® socle femelle pour tissu - Laiton nickelé

814228

Artikel-Nr. Item-no.	L1	Box	*€/Stück *€/piece
814228656	5,6	100	1,60
814228670	7,0	100	1,70



In Kombination mit Artikel 814229
In combination with article 814229
En combinaison avec l'article 814229

3

Druckknopfsysteme Snap fastening systems Système de bouton à pression

814229

Lift-The-DOT® Gegenplatte / Messing vernickelt
Lift-The-DOT® back plate, brass, nickel finish / Système Lift-The-DOT® plaque femelle pour tissu - Laiton nickelé



Artikel-Nr. Item-no.	Box	*€/Stück *€/piece
8142296	100	0,40

In Kombination mit Artikel 814228
In combination with article 814228
En combinaison avec l'article 814228

814230

Lift-The-DOT® Unterteil für Stoffe / Messing vernickelt
Lift-The-DOT® stud for textile, brass, nickel finish / Système Lift-The-DOT® socle mâle pour tissu - Laiton nickelé



Artikel-Nr. Item-no.	L1	Box	*€/Stück *€/piece
814230643	4,3	100	1,00

In Kombination mit Artikel 814231
In combination with article 814231
En combinaison avec l'article 814231

814231

Lift-The-DOT® Gegenplatte / Messing vernickelt
Lift-The-DOT® washer, brass, nickel finish / Système Lift-The-DOT® plaque mâle pour tissu - Laiton nickelé



Artikel-Nr. Item-no.	Box	*€/Stück *€/piece
8142316	100	0,40

In Kombination mit Artikel 814230
In combination with article 814230
En combinaison avec l'article 814230

814232

Lift-The-DOT® Unterteil für Lochstanzung / Messing vernickelt
Lift-The-DOT® stud for punched hole, nickel finish / Système Lift-The-DOT® socle mâle - Laiton nickelé

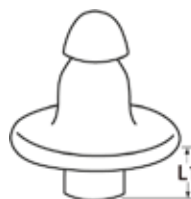

Artikel-Nr. Item-no.	L1	Box	*€/Stück *€/piece
8142326105	10,5	100	2,00

In Kombination mit Artikel 814233
In combination with article 814233
En combinaison avec l'article 814233



Lift-The-DOT® Gegenplatte / Messing vernickelt
 Lift-The-DOT® stud for punched hole, nickel finish / Système Lift-The-DOT® socle mâle - Laiton nickelé

814233

Artikel-Nr. Item-no.	Box	*€/Stück *€/piece
8142336	100	0,30

In Kombination mit Artikel 814232
 In combination with article 814232
 En combinaison avec l'article 814232



Lift-The-DOT® Unterteil mit Holzschraube / Messing vernickelt / Messing
 Lift-The-DOT® stud with wood screw, brass, nickel finish / Système Lift-The-DOT® socle mâle avec vis bois - Laiton nickelé

814234

Artikel-Nr. Item-no.	GW	L1	Box	*€/Stück *€/piece
8142346133 95	4,1	9,5	100	1,90
8142346133 169	4,1	15,9	100	2,00

Kopf Messing vernickelt. Schraube Messing.
 Stud made of nickel plated brass. Screw made of brass.
 Bouton laiton nickelé. Vis laiton.

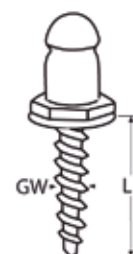

Lift-The-DOT® Unterteil für Windschutzscheibe / Messing vernickelt
 Lift-The-DOT® windshield clip - brass, nickel finish / Système Lift-The-DOT® socle mâle pour pare-brise - Laiton nickelé

814249

Artikel-Nr. Item-no.	iL	Box	*€/Stück *€/piece
814249634	19,1	100	1,90
814249678	22,2	100	2,00

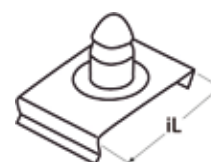

DOT-Common-Sense® Drehverschluss für Lochstanzung / Messing vernickelt
 DOT-Common-Sense® turn button for punched hole / Système DOT-Common-Sense® socle - Laiton nickelé

814237

Artikel-Nr. Item-no.	H1	Box	*€/Stück *€/piece
814237620	20	100	3,10
814237622	22	100	3,30

In Kombination mit Artikel 814238
 In combination with article 814238
 En combinaison avec l'article 814238



3

Druckknopfsysteme Snap fastening systems Système de bouton à pression

814238

DOT-Common-Sense® Gegenplatte / Messing vernickelt
DOT-Common-Sense® back plate - brass, nickel finish / Système DOT-Common-Sense® plaque pour socle - Laiton nickelé



Artikel-Nr. Item-no.	Box	*€/Stück *€/piece
8142386	100	0,40

In Kombination mit Artikel 814237
In combination with article 814237
En combinaison avec l'article 814237

814239

DOT-Common-Sense® Drehverschluss für Stoffe / Messing vernickelt
DOT-Common-Sense® turn button for textile - brass, nickel finish / ***

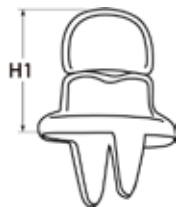

Artikel-Nr. Item-no.	H1	Box	*€/Stück *€/piece
814239618	18	100	1,80
814239621	21	100	2,60

***Systeme DOT-Common-Sense® socle pour tissu - Laiton nickelé

In Kombination mit Artikel 814240
In combination with article 814240
En combinaison avec l'article 814240

814240

DOT-Common-Sense® Gegenplatte / Messing vernickelt
DOT-Common-Sense® back plate - brass, nickel finish / Système DOT-Common-Sense® plaque pour socle - Laiton nickelé



Artikel-Nr. Item-no.	Box	*€/Stück *€/piece
8142406	100	0,40

In Kombination mit Artikel 814239
In combination with article 814239
En combinaison avec l'article 814239

814241

DOT-Common-Sense® Drehverschluss zum Verschrauben / Messing vernickelt
DOT-Common-Sense® turn button for screw fixing - brass, nickel finish / ***

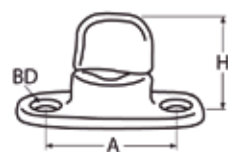

Artikel-Nr. Item-no.	H	A	BD	Box	*€/Stück *€/piece
8142416173	17,3	21,7	4,1	100	1,60
8142416200	20,0	21,7	4,1	100	2,40

***Systeme DOT-Common-Sense® socle à visser - Laiton nickelé



DOT-Common-Sense® Drehverschluss mit Blechschraube / Messing vernickelt
DOT-Common-Sense® turn button, self drilling screw - brass, nickel finish / ***

814242

Artikel-Nr. Item-no.	GW	H1	L1	Box	*€/Stück *€/piece
814242620	5,9	20	15,9	100	6,70

***Système DOT-Common-Sense® socle, vis autoperceuse - Laiton nickélé



DOT-Common-Sense® Drehverschluss mit Holzschraube / Messing vernickelt
DOT-Common-Sense® turn button with wood screw - brass, nickel finish / ***

814243

Artikel-Nr. Item-no.	GW	H1	L1	Box	*€/Stück *€/piece
814243620	4	20	15,9	100	6,60

***Système DOT-Common-Sense® socle avec vis bois - Laiton nickélé



DOT-Common-Sense® Öse für Stoffe / Messing vernickelt
DOT-Common-Sense® grommet - brass, nickel finish / Système DOT-Common-Sense® œillet - Laiton nickélé

814244

Artikel-Nr. Item-no.	L1	Box	*€/Stück *€/piece
814244685	8,5	100	0,50
814244698	9,8	100	0,80

In Kombination mit Artikel 814245

In combination with article 814245

En combinaison avec l'article 814245



DOT-Common-Sense® Gegenplatte / Messing vernickelt
DOT-Common-Sense® washer - brass, nickel finish / Système DOT-Common-Sense® plaque pour œillet - Laiton nickélé

814245

Artikel-Nr. Item-no.	Box	*€/Stück *€/piece
8142456	100	0,60

In Kombination mit Artikel 814244

In combination with article 814244

En combinaison avec l'article 814244



3

Druckknopfsysteme Snap fastening systems Système de bouton à pression

814246

DOT-Common-Sense® Gegenplatte, schwer / Messing vernickelt
DOT-Common-Sense® washer, heavy duty - brass, nickel finish / ***



Artikel-Nr. Item-no.	Box	*€/Stück *€/piece
8142466	100	0,50

***Système DOT-Common-Sense® plaque lourd pour œillet - Laiton nickélé

In Kombination mit Artikel 814244
In combination with article 814244
En combinaison avec l'article 814244

814247

DOT® Öse / Messing vernickelt
DOT® sheet grommet - brass, nickel finish / Système DOT® œillet - Laiton nickélé

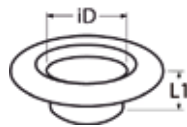

Artikel-Nr. Item-no.	Nr.	L1	iD	Box	*€/Stück *€/piece
8142476063 53	2	5,3	6,3	100	0,12
8142476073 53	3	5,3	7,3	100	0,16
8142476124 102	6	10,2	12,4	100	0,55

In Kombination mit Artikel 814248
In combination with article 814248
En combinaison avec l'article 814248

814248

DOT® Gegenplatte / Messing vernickelt
DOT® plain washer - brass, nickel finish / Système DOT® plaque pour œillet - Laiton nickélé

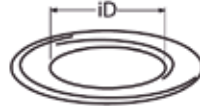

Artikel-Nr. Item-no.	Nr.	iD	Box	*€/Stück *€/piece
8142486074	2	7,4	100	0,10
8142486090	3	9,0	100	0,14
8142486150	6	15,0	100	0,30

In Kombination mit Artikel 814247
In combination with article 814247
En combinaison avec l'article 814247

814951

DOT® Öse und verzahnte Gegenplatte / A2-AISI 304
DOT® sheet grommet with toothed neck washer / Système DOT® œillet et contre-plaque denté

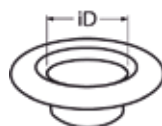

Artikel-Nr. Item-no.	Nr.	iD	Box	*€/Stück *€/piece
8149512067 40	1	6,7	100	0,70
8149512082 62	2	8,2	100	1,00
8149512095 54	3	9,5	100	1,10
8149512112 56	4	11,2	100	1,50
8149512125 65	5	12,5	100	1,60
8149512159 82	6	15,9	100	2,00



Universal Snap-Befestigung Mini / Plastik

Universal snap-in plunger mini / Système de fixation clip universel mini

814742

Artikel-Nr. Item-no.	H	H1	D	D1	Klemmbereich Clamping area	BD	Box	*€/Stück *€/piece
814742339	46	14	39	13	0-13	4	2	22,00
81474210M	ALU						1	29,50

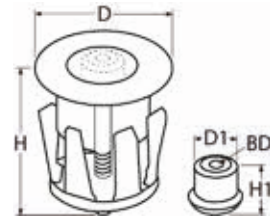

81474210M

Markierungsdorn für Snap-Befestigung
Marking punch for snap-in plunger
Épave de montage pour système de fixation



Universell einsetzbar zur Befestigung von Polsterungen, Türen, Paneelen, Deckenverkleidungen etc. Haltekraft 8kg

Universally applicable for mounting upholstery, doors, panels or ceiling panels. Holding force 8kg.

Utilisation universelle pour la fixation de meubles rembourrés, de portes, de panneaux, de revêtement de plafond, etc. Force de maintien 8kg.



Universal Snap-Befestigung / Plastik

Universal snap-in plunger / Système de fixation clip universel

814743

Artikel-Nr. Item-no.	H	H1	D	D1	Klemmbereich Clamping area	BD	Box	*€/Stück *€/piece
814743360	62	27	60	25	3-19	6	2	22,90
81474310M	ALU						1	33,00

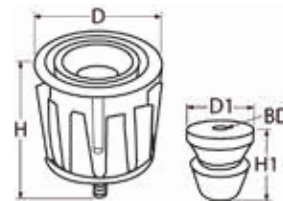

81474310M

Markierungsdorn für Snap-Befestigung
Marking punch for snap-in plunger
Épave de montage pour système de fixation



Universell einsetzbar zur Befestigung von Polsterungen, Türen, Paneelen, Deckenverkleidungen etc. Haltekraft ca.10kg

Universally applicable for mounting upholstery, doors, panels or ceiling panels. Holding force approximately 10kg.

Utilisation universelle pour la fixation de meubles rembourrés, de portes, de panneaux, de revêtement de plafond, etc. Force de maintien env. 10kg.

Installations Anleitung / Installation Instruction

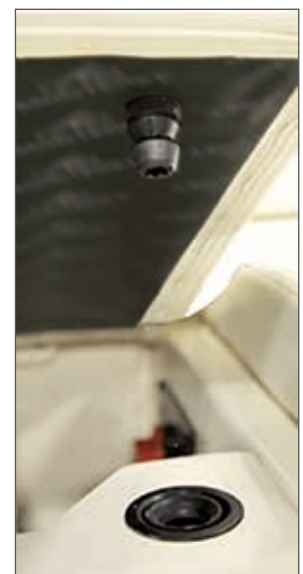



Rohre, Relingsbeschläge, Scheuerleiste und Zubehör

Tubes, rail fittings, rub strakes and accessories

Tubes, embases, liston de protection et accessories

Kapitel 4

Chapter 4



Rohre + Beschläge

Tubes + accessories

Tubes + accessories



Haken und Halter

Hooks and holder

Crochets et supports



Relingsbeschläge

Rail fittings

Embases + platines



Decksplatten + Mastplatten

Mounting plates

Cadènes



Griffe und Handlauf

Handles and rails

Poignées et embouts



Yachtzubehör + Ausrüstung

Yachting accessories + equipment

Accessories pour yachts + equipment

4

Rohre, Relingsbeschläge, Scheuerleiste und Zubehör

Tubes, rail fittings, rub strakes and accessories

Tubes, embases, liston de protection et accessoires

8292

Edelstahlrohr, geschweißt, biegefähig / A2-AISI 304 / A4L-AISI 316L

Stainless steel tube, welded, bendable / Tube soudé et pliable



Artikel-Nr. A2 Item-no. A2	Artikel-Nr. A4L Item-no. A4L	D	S	L	*€/m A2	*€/m A4L
8292219	8292419	19	1,5	6000	10,00	18,10
8292220	8292420	20	1,5	6000	13,50	20,30
8292222	8292422	22	1,5	6000	15,00	22,50
NEW	82924221000	22	1,5	1000	–	23,00
–	82924221500	22	1,5	1500	–	24,00
–	8292422 7	22	1,5	7000	–	22,50
8292225	8292425	25	1,5	6000	16,00	24,80
NEW	82924251000	25	1,5	1000	–	27,40
–	82924251500	25	1,5	1500	–	28,00
–	8292425 7	25	1,5	7000	–	24,80
–	829242520 7	25	2,0	7000	–	26,50
8292230	8292430	30	1,5	6000	21,00	31,50
NEW	82924301000	30	1,5	1000	–	34,30
–	82924301500	30	1,5	1500	–	35,00
–	829243020	30	2,0	6000	–	42,00
–	829244020	40	2,0	6000	–	59,00
–	829245020	50	2,0	6000	–	95,00
–	829246020	60	2,0	6000	–	114,00

8532

Haltegriffverbinder, Doppelschelle / A2-AISI 304

Grab handle connector, double clamp / Fixation pour tube

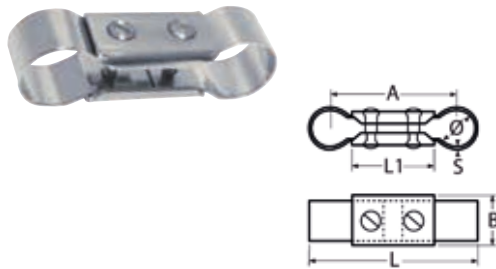

Artikel-Nr. Item-no.	Für Rohr-Ø For tube-Ø	L	L1	B	A	S	Box	*€/Stück *€/piece
8532222	22	90	44	27	68	1	1	9,60
8532225	25	96	44	27	69	1	1	10,00

814642

Haltegriffverbinder, massiv / A4-AISI 316

Grab handle connector, heavy duty / Fixation pour tube

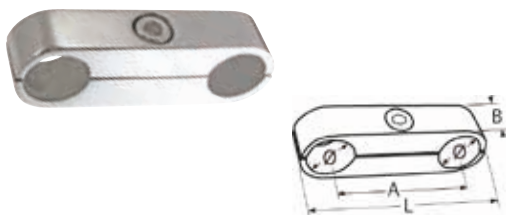

Artikel-Nr. Item-no.	Für Rohr-Ø For tube-Ø	L	B	A	Box	*€/Stück *€/piece
814642422	22	106	20	77	1	23,50
814642425	25	106	20	78	1	32,00

Rohre, Relingsbeschläge, Scheuerleiste und Zubehör

Tubes, rail fittings, rub strakes and accessories
 Tubes, embases, liston de protection et accessoires

4

Rohrschnellverschluss / A4-AISI 316 Tube quick-release / Tube fermeture rapide

8531

Artikel-Nr. Item-no.	Für Rohr-Ø For tube-Ø	L	L1	L2	D	Box	*€/Stück *€/piece
8531422	22	150	80	35	18,7	1	25,30
8531425	25	150	80	35	21,7	1	27,00

Die Angabe "Für Rohr-Ø" gilt für Rohre mit 1,5mm Wandungsstärke.
 The specification "For tube-Ø" applies to tubes with wall thickness 1.5mm.
 La spécification "Pour tube-Ø" s'applique aux tubes avec une épaisseur de paroi de 1,5mm.

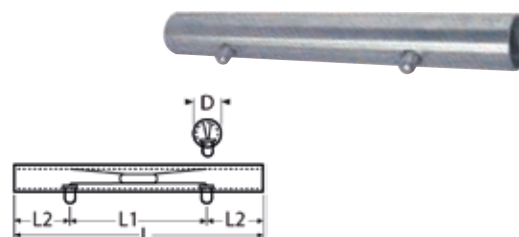

Relingstütze / A4-AISI 316 Stanchion / Chandelier

8546

Artikel-Nr. Item-no.	H	H1	D	iD	S	Box	*€/Stück *€/piece
85464410	450	–	25	10,5	2	1	45,10
85464610	610	300	25	10,5	2	1	57,00
85464740	740	300	25	10,5	2	1	68,80



Pfortenstütze / A4-AISI 316 Rail gate stanchion / Support de porte

814316

Artikel-Nr. Item-no.	H	H1	H2	D	A	L1	S	Box	*€/Stück *€/piece
8143164610	610	310	100	25	300	92	1,5	1	105,00
8143164740	740	440	100	25	300	92	1,5	1	112,00

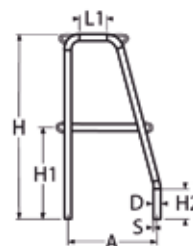

Relingfuß mit Innengewinde, 60° / A4-AISI 316 Rail base with internal thread, 60° / Embase chandelier 60° avec filetage interne

814304

Artikel-Nr. Item-no.	Für Rohr-Ø For tube-Ø	GW	H	L1	B	Box	*€/Stück *€/piece
814304425	25	M8	67	52	44	1	39,00
814304430	30	M8	86	56	47	1	60,00

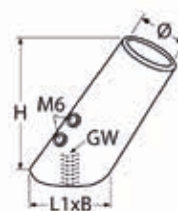

4

Rohre, Relingsbeschläge, Scheuerleiste und Zubehör

Tubes, rail fittings, rub strakes and accessories

Tubes, embases, liston de protection et accessories

814305

Relingfuß mit Innengewinde, 90° / A4-AISI 316

Rail base with internal thread, 90° / Embase chandelier 90° avec filetage interne



Artikel-Nr. Item-no.	Für Rohr-Ø For tube-Ø	GW	D	H	Box	*€/Stück *€/piece
814305425	25	M8	45	69	1	39,00
814305430	30	M8	51	78	1	60,00

814306

Relingfuß mit Innengewinde, 60° / A4-AISI 316

Rail base with internal thread, 60° / Embase chandelier 60° avec filetage interne

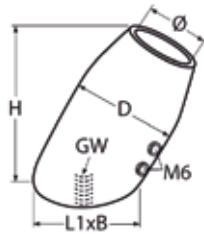

Artikel-Nr. Item-no.	Für Rohr-Ø For tube-Ø	GW	H	D	L1	B	Box	*€/Stück *€/piece
814306425	25	M8	65	45	45	50	1	30,00

814307

Relingfuß mit Innengewinde, 90° / A4-AISI 316

Rail base with internal thread, 90° / Embase chandelier 90° avec filetage interne

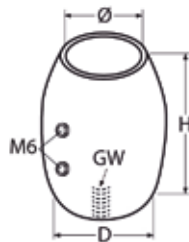

Artikel-Nr. Item-no.	Für Rohr-Ø For tube-Ø	GW	D	H	Box	*€/Stück *€/piece
814307425	25	M8	45	57	1	30,00

8201

Relingfuß mit runder Grundplatte, 90° / A4-AISI 316

Round rail base, 90° / Embase chandelier 90° avec platine ronde

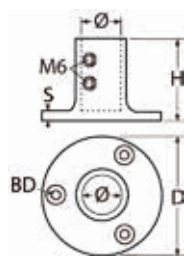

Artikel-Nr. Item-no.	Für Rohr-Ø For tube-Ø	D	H	S	BD	Box	*€/Stück *€/piece
8201422	22	63,5	43	5	5,3	1	17,80
8201425	25	70,0	43	5	6,4	1	18,00

Rohre, Relingsbeschläge, Scheuerleiste und Zubehör

Tubes, rail fittings, rub strakes and accessories
 Tubes, embases, liston de protection et accessoires

4

Relingfuß mit runder Grundplatte, 60° / A4-AISI 316 Round rail base, 60° / Embase chandelier 60° avec platine rectangulaire

8202

Artikel-Nr. Item-no.	Für Rohr-Ø For tube-Ø	D	H	S	BD	Box	*€/Stück *€/piece
8202422	22	66	46	5	5,3	1	15,30
8202425	25	70	46	5	6,4	1	17,30

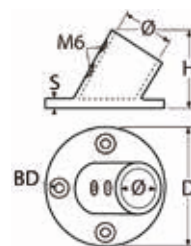

Relingfuß mit rechteckiger Grundplatte, 90° / A4-AISI 316 Square rail base, 90° / Embase chandelier 90° avec platine rectangulaire

8203

Artikel-Nr. Item-no.	Für Rohr-Ø For tube-Ø	L	B	H	S	BD	Box	*€/Stück *€/piece
8203422	22	78	43	43	5	5,3	1	14,60
8203425	25	81	48	43	5	6,4	1	17,60

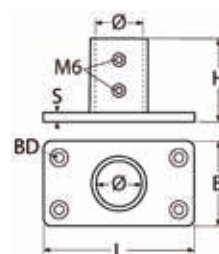

Relingfuß mit rechteckiger Grundplatte, 60° / A4-AISI 316 Square rail base, 60° / Embase chandelier 60° avec platine rectangulaire

8204

Artikel-Nr. Item-no.	Für Rohr-Ø For tube-Ø	L	B	H	S	BD	Box	*€/Stück *€/piece
8204422	22	78	43	46	5	5,3	1	19,10
8204425	25	81	48	46	5	6,4	1	20,00

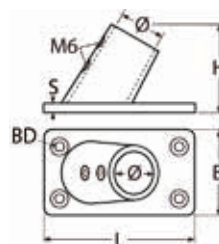

Relingfuß mit runder Grundplatte, 30° / A4-AISI 316 Round rail base, 30° / Embase chandelier 30° avec platine ronde

8325

Artikel-Nr. Item-no.	Für Rohr-Ø For tube-Ø	D	H	S	BD	Box	*€/Stück *€/piece
8325422	22	63,5	39	5	5,3	1	14,00
8325425	25	70,0	39	5	6,4	1	16,00

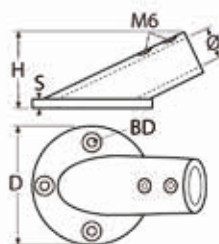

4

Rohre, Relingsbeschläge, Scheuerleiste und Zubehör

Tubes, rail fittings, rub strakes and accessories

Tubes, embases, liston de protection et accessoires

814909

Rohrhalter / A4-AISI 316

Tube holder / Embase pour tube

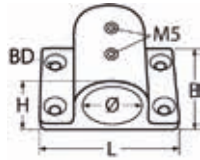

Artikel-Nr. Item-no.	Für Rohr-Ø For tube-Ø	L	B	H	BD	Box	*€/Stück *€/piece
814909422	22	58,0	46	29,5	5	1	23,40
814909425	25	61,5	46	33,0	5	1	26,40



814607

Perseuning-Rohrhalter, versenkt / A4-AISI 316

Tarp tube holder, countersunk / Embase pour tube encastrable

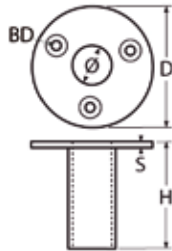

NEW

NEW

Artikel-Nr. Item-no.	Für Rohr-Ø For tube-Ø	D	H	S	BD	Box	*€/Stück *€/piece
814607420	20	63,5	68	4	6,4	1	17,50
814607422	22	63,5	68	4	6,4	1	18,00
81460742568	25	70,0	68	4	6,4	1	24,00
81460743068	30	70,0	68	4	6,4	1	24,50

8360

Relingfuß, 90° / A4-AISI 316

Rail base, 90° / Embase de chandelier 90°

83604RECHTECK

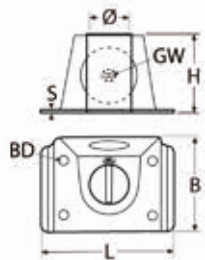

NEW

NEW

Artikel-Nr. Item-no.	Für Rohr-Ø For tube-Ø	L	B	H	S	BD	GW	Box	*€/Stück *€/piece
83604DREIECK	25	87	75	54	2	7,5	M5	1	26,30
83604RECHTECK	25	90	64	54	2	7,5	M5	1	30,00

83604DREIECK

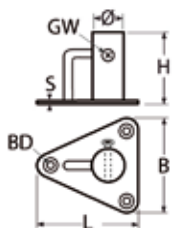

Rohre, Relingsbeschläge, Scheuerleiste und Zubehör

Tubes, rail fittings, rub strakes and accessories
 Tubes, embases, liston de protection et accessories

4

Relingfuß mit Dreiecksplatte, 3° / A4-AISI 316

Triangular stanchion base, 3° / Embase chandelier 3° avec platine triangulaire

8632

Artikel-Nr. Item-no.	Für Rohr-Ø For tube-Ø	L	B	H	A	S	BD	Box	*€/Stück *€/piece
8632425	25	86	86	72	60	3	6,5	1	42,40

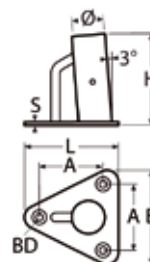

Relingfuß mit Dreiecksplatte, 5° / A4-AISI 316

Triangular stanchion base, 5° / Embase chandelier 5° avec platine triangulaire

8633

Artikel-Nr. Item-no.	Für Rohr-Ø For tube-Ø	L	B	H	A	S	BD	Box	*€/Stück *€/piece
8633425	25	86	86	72	60	3	6,5	1	38,00

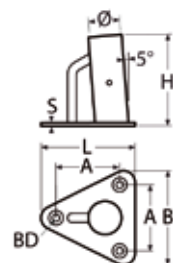

Relingfuß mit Dreiecksplatte, erhöht, 3° / A4-AISI 316

Triangular stanchion base on toe rail, 3° / Embase chandelier 3° avec platine triangulaire

8634

Artikel-Nr. Item-no.	Für Rohr-Ø For tube-Ø	L	B	H	H1	A	S	BD	Box	*€/Stück *€/piece
8634425	25	85	86	78	5	60	3	6,5	1	40,00

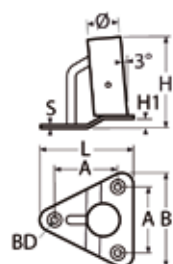

Relingfuß mit Dreiecksplatte, erhöht, 5° / A4-AISI 316

Triangular stanchion base on toe rail, 5° / Embase chandelier 5° avec platine triangulaire

8635

Artikel-Nr. Item-no.	Für Rohr-Ø For tube-Ø	L	B	H	H1	A	S	BD	Box	*€/Stück *€/piece
8635425	25	85	86	78	5	60	3	6,5	1	40,00

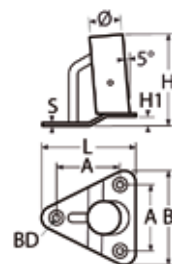

4

Rohre, Relingsbeschläge, Scheuerleiste und Zubehör

Tubes, rail fittings, rub strakes and accessories

Tubes, embases, liston de protection et accessoires

8907

Gegenplatte, rund / A2-AISI 304

Round counter plate / Platine ronde

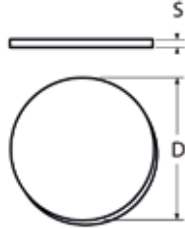

Artikel-Nr. Item-no.	D	S	Box	*€/Stück *€/piece
8907275	75	3	5	14,50

8908

Gegenplatte, oval / A2-AISI 304

Oval counter plate / Platine ovale



Artikel-Nr. Item-no.	L	B	S	Box	*€/Stück *€/piece
8908275 30	75	30	3	5	12,60

8909

Gegenplatte, rechteckig / A2-AISI 304

Square counter plate / Platine rectangulaire



Artikel-Nr. Item-no.	L	B	S	Box	*€/Stück *€/piece
8909280 45	80	45	3	5	17,60

8612

Relingschweißfuß rund, 45° / A4-AISI 316

Round base for welding, 45° / Embase chandelier à souder 45°, platine ronde

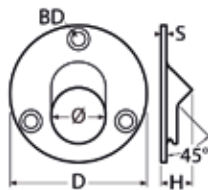

Artikel-Nr. Item-no.	Für Rohr-Ø For tube-Ø	D	H	S	BD	Box	*€/Stück *€/piece
8612422	22	69	15	3	6	1	15,00
8612425	25	75	15	3	8	1	16,00

Rohre, Relingsbeschläge, Scheuerleiste und Zubehör

Tubes, rail fittings, rub strakes and accessories
 Tubes, embases, liston de protection et accessoires

4

Relinganschweißfuß rund, 60° / A4-AISI 316

Round base for welding, 60° / Embase chandelier à souder 60°, platine ronde

8613

Artikel-Nr. Item-no.	Für Rohr-Ø For tube-Ø	D	H	S	BD	Box	*€/Stück *€/piece
8613422	22	69	14	3	6	1	11,70
8613425	25	75	14	3	8	1	14,70

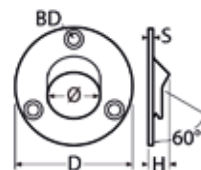

Relinganschweißfuß rund, 90° / A4-AISI 316

Round base for welding, 90° / Embase chandelier à souder 90°, platine ronde

8614

Artikel-Nr. Item-no.	Für Rohr-Ø For tube-Ø	D	H	S	BD	Box	*€/Stück *€/piece
8614422	22	69	10	3	6	1	11,50
8614425	25	75	10	3	8	1	14,00

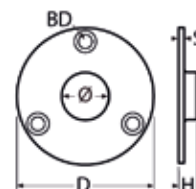

Relinganschweißfuß, 45° / A4-AISI 316

Base for welding, 45° / Embase chandelier à souder 45°, platine rectang.

8615

Artikel-Nr. Item-no.	Für Rohr-Ø For tube-Ø	L	B	H	S	BD	Box	*€/Stück *€/piece
8615422	22	80	45	15	3	6	1	13,80
8615425	25	80	45	15	3	8	1	14,00

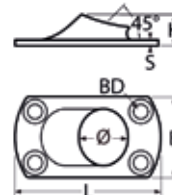

Relinganschweißfuß, 60° / A4-AISI 316

Base for welding, 60° / Embase chandelier à souder 60°, platine rectang.

8616

Artikel-Nr. Item-no.	Für Rohr-Ø For tube-Ø	L	B	H	S	BD	Box	*€/Stück *€/piece
8616422	22	80	45	15	3	6	1	11,90
8616425	25	80	45	15	3	8	1	12,00

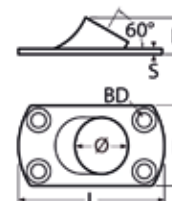

4

Rohre, Relingsbeschläge, Scheuerleiste und Zubehör

Tubes, rail fittings, rub strakes and accessories

Tubes, embases, liston de protection et accessoires

8617

Relinganschweißfuß, 90° / A4-AISI 316

Base for welding, 90° / Embase chandelier à souder 90°, platine rectang.

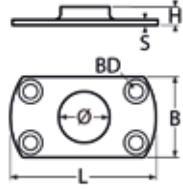

Artikel-Nr. Item-no.	Für Rohr-Ø For tube-Ø	L	B	H	S	BD	Box	*€/Stück *€/piece
8617422	22	80	45	10	3	6	1	10,50
8617425	25	80	45	10	3	8	1	11,00

8205

T-Stück, 90° / A4-AISI 316

T-fitting, 90° / Té droite, 90°

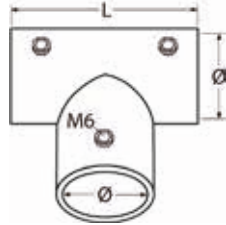

Artikel-Nr. Item-no.	Für Rohr-Ø For tube-Ø	L	Box	*€/Stück *€/piece
8205422	22	50	1	13,30
8205425	25	55	1	16,70
8205430	30	49	1	17,10

8822

T-Stück teilbar, 90° / A4-AISI 316

T-fitting hinged, 90° / Té droit 90° avec charnière



Artikel-Nr. Item-no.	Für Rohr-Ø For tube-Ø	L	Box	*€/Stück *€/piece
8822422	22	50	1	24,60
8822425	25	55	1	29,60

814699

T-Stück geteilt, 60° / A4-AISI 316

T-fitting 2-part, 60° / Té incliné 60° avec charnière

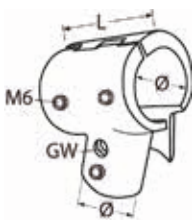

Artikel-Nr. Item-no.	Für Rohr-Ø For tube-Ø	L	GW	Box	*€/Stück *€/piece
814699422	22	50	M8	1	25,90
814699425	25	50	M8	1	29,80

Rohre, Relingsbeschläge, Scheuerleiste und Zubehör

Tubes, rail fittings, rub strakes and accessories
 Tubes, embases, liston de protection et accessoires

4

T-Stück, 60° / A4-AISI 316
 T-fitting, 60° / Té incliné 60°

8206

Artikel-Nr. Item-no.	Für Rohr-Ø For tube-Ø	Ausführung Type	L	Box	*€/Stück *€/piece
82064R22	22	Rechts / Right	50	1	20,00
82064L22	22	Links / Left	50	1	20,00
82064U22	22	Universal	50	1	20,00
82064R25	25	Rechts / Right	55	1	21,00
82064L25	25	Links / Left	55	1	21,00
82064U25	25	Universal	55	1	21,00



Links / left / la gauche



Rechts / right / droite

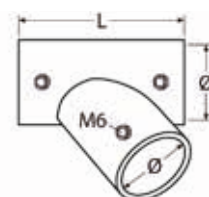

Relingeckverbinder, 90° / A4-AISI 316
 Elbow fitting, 90° / Coude angle, 90°

8210

Artikel-Nr. Item-no.	Für Rohr-Ø For tube-Ø	L	Box	*€/Stück *€/piece
8210422	22	49	1	16,30
8210425	25	51	1	17,00

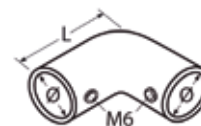

3-Wege Relingeckverbinder / A4-AISI 316
 3-way corner fitting / Angle 90° trois départs

8211

Artikel-Nr. Item-no.	Für Rohr-Ø For tube-Ø	L	Box	*€/Stück *€/piece
8211422	22	55	1	24,00
8211425	25	56	1	25,00



NEW

Vierwege Rohrverbinder / A4-AISI 316
 Four-way tube connector / Connecteur de tube à quatre voies

815158

Artikel-Nr. Item-no.	Ø	L	Box	*€/Stück *€/piece
815158422	22	80	1	28,00
815158425	25	80	1	29,50

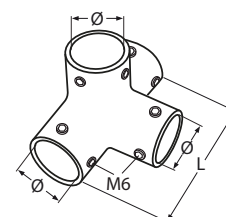

4

Rohre, Relingsbeschläge, Scheuerleiste und Zubehör

Tubes, rail fittings, rub strakes and accessories

Tubes, embases, liston de protection et accessoires

8387

4-Wege-Relingebinder / A4-AISI 316

4-way-fitting / Support en croix

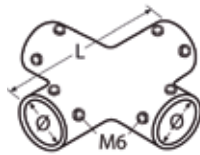

Artikel-Nr. Item-no.	Für Rohr-Ø For tube-Ø	L	Box	*€/Stück *€/piece
8387422	22	84	1	22,90
8387425	25	84	1	26,00

8565

Relingverbinder, 110° / A4-AISI 316

Elbow fitting, 110° / Coude angle, 110°

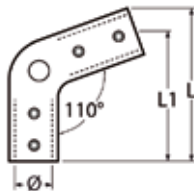

Artikel-Nr. Item-no.	Für Rohr-Ø For tube-Ø	L	L1	Box	*€/Stück *€/piece
8565422	22	90	79	1	36,80
8565425	25	93	82	1	42,53

8562

Relingverbinder, 140° / A4-AISI 316

Elbow fitting, 140° / Coude angle, 140°

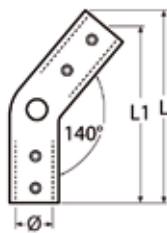

Artikel-Nr. Item-no.	Für Rohr-Ø For tube-Ø	L	L1	Box	*€/Stück *€/piece
8562422	22	112	105	1	22,40
8562425	25	115	108	1	37,00

8208

Handlaufendstück, 60°, MT-Serie / A4-AISI 316

Handrail end fitting, 60°, MT series / Embout main courante, 60°, MT série

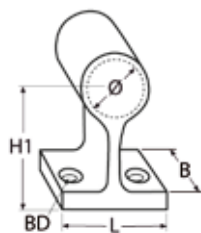

Artikel-Nr. Item-no.	Für Rohr-Ø For tube-Ø	H1	L	B	BD	Box	*€/Stück *€/piece
8208422	22	38	40	29	5,3	1	13,30
8208425	25	38	42	32	5,3	1	16,00

Das Rohr muss in einem Winkel von 60° zugeschnitten werden, damit eine maximale Einstecktiefe gewährleistet und ein axiales Verdrehen des Rohres verhindert wird.

The tube must be cut at an angle of 60°, so that a maximum insertion is guaranteed and an axial twisting of the tube is prevented.

Le tube doit être coupé dans un angle de 60°, de sorte qu'une insertion maximale soit garantie et une torsion axiale du tube soit empêchée.

Rohre, Relingsbeschläge, Scheuerleiste und Zubehör

Tubes, rail fittings, rub strakes and accessories
 Tubes, embases, liston de protection et accessoires

4

Handlaufdurchlass, 60° / A4-AISI 316

Handrail center fitting, 60° / Passage main courante, 60°

8207

Artikel-Nr. Item-no.	Für Rohr-Ø For tube-Ø	H1	L	B	BD	Box	*€/Stück *€/piece
8207422 38	22	38	40	26	5,3	1	10,70
8207425 45	25	38	42	29	5,3	1	13,90

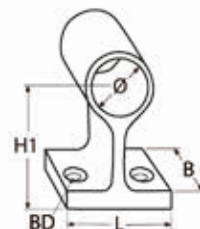

Handlauf Mittelstück / A4-AISI 316

Handrail center fitting / Passage main courante

814410

Artikel-Nr. Item-no.	Für Rohr-Ø For tube-Ø	H1	BD	Box	*€/Stück *€/piece
814410425	25	46	4,8	1	16,10

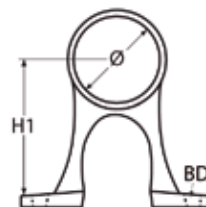

Handlaufdurchlass, 60° / A4-AISI 316

Handrail center fitting, 60° / Passage main courante, 60°

8209

Artikel-Nr. Item-no.	Für Rohr-Ø For tube-Ø	GW	L1	B	H1	S	Box	*€/Stück *€/piece
8209422	22	M6	33	35	38	4,5	1	9,60
8209425	25	M6	33	35	38	4,5	1	10,00

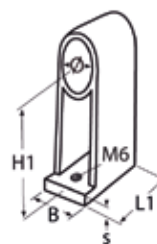

Handlaufendstück, 60° / A4-AISI 316

Handrail end fitting, 60° / Embout main courante 60°

8213

Artikel-Nr. Item-no.	Für Rohr-Ø For tube-Ø	L1	B	H1	BD	Box	*€/Stück *€/piece
8213422	22	33	35	50	5,3	1	12,90
8213425	25	33	35	52	5,3	1	15,10

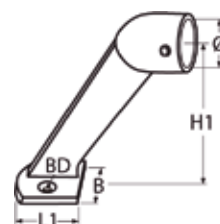

4

Rohre, Relingsbeschläge, Scheuerleiste und Zubehör

Tubes, rail fittings, rub strakes and accessories

Tubes, embases, liston de protection et accessoires

815029

Handlaufdurchlass, 60° / A4-AISI 316

Handrail center fitting, 60° / Passage main courante, 60°

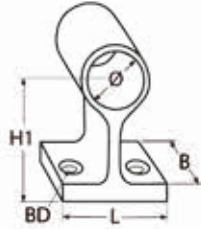

Artikel-Nr. Item-no.	Für Rohr-Ø For tube-Ø	L	B	H1	BD	Box	*€/Stück *€/piece
815029422	22	37	35	50	5,3	1	17,60
815029425	25	42	31	52	5,3	1	19,20

8702

Handlaufendstück mit Gewinde / A4-AISI 316

Handrail end fitting with external thread / Embout main courante avec filetage

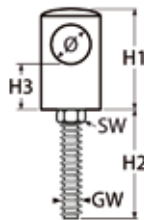

Artikel-Nr. Item-no.	Für Rohr-Ø For tube-Ø	GW	H1	H2	H3	Antrieb Drive	Box	*€/Stück *€/piece
87024022	22	M8	58	55	27	SW13	1	43,00
87024025	25	M8	58	55	27	SW13	1	45,00

8703

Handlaufdurchlass mit Gewinde / A4-AISI 316

Handrail center fitting with external thread / Passage main courante avec filetage

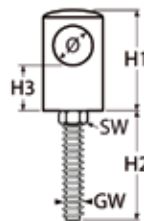

Artikel-Nr. Item-no.	Für Rohr-Ø For tube-Ø	GW	H1	H2	H3	Antrieb Drive	Box	*€/Stück *€/piece
87034022	22	M8	58	55	27	SW13	1	38,00
87034025	25	M8	58	55	27	SW13	1	44,30

814962

Handlaufendstück mit Gewinde / A4-AISI 316

Hand rail end fitting with thread / Embout main courante avec filetage

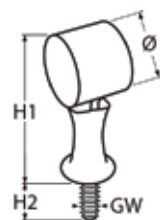

Artikel-Nr. Item-no.	Für Rohr-Ø For tube-Ø	GW	H1	H2	Box	*€/Stück *€/piece
814962425	25	M8	62	28	1	38,70

Rohre, Relingsbeschläge, Scheuerleiste und Zubehör

Tubes, rail fittings, rub strakes and accessories
Tubes, embases, liston de protection et accessories

4



Handlaufdurchlass mit Gewinde / A4-AISI 316
Hand rail centre fitting with thread / Passage main courante avec filetage

814961

Artikel-Nr. Item-no.	Für Rohr-Ø For tube-Ø	GW	H1	H2	Box	*€/Stück *€/piece
814961425	25	M8	62	28	1	37,00

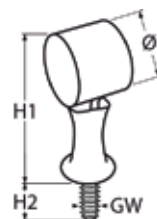

Handlaufendstück, 8° / A4-AISI 316
Handrail end fitting, 8° / Embout main courante, 8°

8214

Artikel-Nr. Item-no.	Für Rohr-Ø For tube-Ø	L	BD	Box	*€/Stück *€/piece
8214422	22	125	5,3	1	18,90



Handlaufendstück, 90° / A4-AISI 316
Handrail end fitting, 90° / Embout main courante, 90°

8212

Artikel-Nr. Item-no.	Für Rohr-Ø For tube-Ø	GW	L	H1	Box	*€/Stück *€/piece
8212422	22	M6	171	38	1	26,80
8212425	25	M6	175	38	1	28,40



Handlaufhalter Mittelstück, MT-Serie / A4-AISI 316
Hand rail center fitting, MT series / Fixation passage pour tube, Série MT

814684

Artikel-Nr. Item-no.	Für Rohr-Ø For tube-Ø	L	L1	GW	Antrieb Drive	Box	*€/Stück *€/piece
814684425	25	112	40	M5	SW4	1	26,30

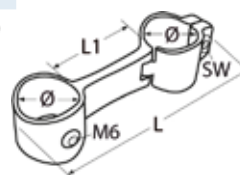

4

Rohre, Relingsbeschläge, Scheuerleiste und Zubehör

Tubes, rail fittings, rub strakes and accessories

Tubes, embases, liston de protection et accessoires



814685

Handlaufhalter Endstück, MT-Serie / A4-AISI 316

Handrail end fitting, MT series / Fixation embout pour tube, Série MT

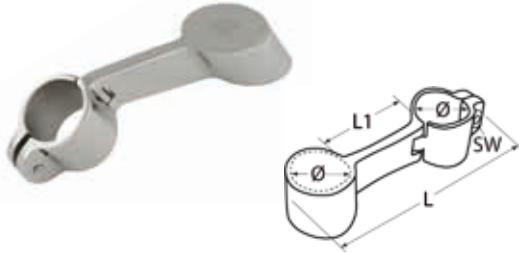

Artikel-Nr. Item-no.	Für Rohr-Ø For tube-Ø	L	L1	GW	Antrieb Drive	Box	*€/Stück *€/piece
814685425	25	112	40	M5	SW4	1	32,50

814589

Spritzkappenhandlaufhalter Set / A4-AISI 316

Sprayhood rail holder set / Kit embout main courante pour deux rampes



Artikel-Nr. Item-no.	Für Rohr-Ø For tube-Ø	Ausführung Type	Box	*€/Stück *€/piece
814589422	22	Set	1	144,00
NEW 814589422R	22	Ersatzstellring / Replacement holder ring	2	10,00
814589425	25	Set	1	146,00
NEW 814589425R	25	Ersatzstellring / Replacement holder ring	2	11,00

Passend zu Art. 814589, 814637 und 814638

For item 814589, 814637 and 814638

Convenable pour art. 814589, 814637 et 814638



Technische Informationen

Technical information

Informations techniques

Bestehend aus:

4x Halter für 22mm Rohr

4x Stellringe für 22/25mm Rohr

4x Gewindestifte DIN 914 M6x16mm

4x Gewindestifte DIN 914 M6x20mm (für dickere Stofflagen)

4x EPDM Dichtscheiben, 4x Schrauben ISO 7380 M6x16mm

Consisting of:

4x end brackets for 22mm tube

4x holder rings for 22/25mm tube

4x set screws DIN 914 M6x16mm

4x set screws DIN 914 M6x20mm (for thicker fabric)

4x EPDM sealing washers, 4x screws ISO 7380 M6x16mm

Se composer de:

4x support pour tube 22mm

4x anneaux de retenue pour 22/25mm tube

4x vis sans tête DIN 914 M6x16mm

4x vis sans tête DIN 914 M6x20mm (pour un tissu plus épais)

4x rondelles avec EPDM, 4x vis à tête ISO 7380 M6x16mm



Rohre, Relingsbeschläge, Scheuerleiste und Zubehör

Tubes, rail fittings, rub strakes and accessories
 Tubes, embases, liston de protection et accessories

4

Spritzkappenhandlaufhalter Set mit Gelenk / A4-AISI 316 Sprayhood rail holder set with joint / Kit embout main courante avec joint

814637

Artikel-Nr. Item-no.	Für Rohr-Ø For tube-Ø	Box	*€/Stück *€/piece
814637422	22	1	126,00
814637425	25	1	128,00



Technische Informationen
 Technical information
 Informations techniques



Bestehend aus:

- 1x Halter für 22mm Rohr
- 1x Gelenk für 22mm Rohr (Schwenkwinkel 90° nach unten und 45° nach oben)
- 1x Stelling für 22/25mm Rohr, 1x Gewindestift DIN 914 M6x20mm
- 1x EPDM Dichtscheibe, 1x Schraube ISO 7380 M6x10mm

Consisting of:

- 1x end bracket for 22mm tube
- 1x joint for 22mm tube (angle of slew 90° down and 45° up)
- 1x holder ring for 22/25mm tube, 1x set screw DIN 914 M6x20mm
- 1x EPDM sealing washer,
- 1x screw ISO 7380 M6x10mm

Se composer de:

- 1x support pour tube 22mm
- 1x joint pour tube 22mm (angle de pivotement 90° vers le bas et 45° vers le haut)
- 1x anneaux de retenue pour 22/25mm tube, 1x vis sans tête DIN 914 M6x20mm
- 1x rondelle avec EPDM, 1x vis à tête ISO 7380 M6x10mm

Rohrstütze für Spritzkappenhandlauf / A4-AISI 316 Tube holder for sprayhood rail / Montant de tube pour main courante

814638

Artikel-Nr. Item-no.	Für Rohr-Ø For tube-Ø	Box	*€/Stück *€/piece
814638422	22	1	62,00
814638425	25	1	64,00



Bestehend aus:

- 1x Rohrstütze für 22mm Rohr
- 1x Stelling für 22/25mm Rohr
- 1x Gewindestift DIN 914 M6x20mm
- 1x EPDM Dichtscheibe

Consisting of:

- 1x tube holder for 22mm tube
- 1x holderring for 22/25mm tube
- 1x set screw DIN 914 M6x20mm
- 1x EPDM sealing washer

Se composer de:

- 1x support de tube 22mm
- 1x anneau de retenue pour 22/25mm tube
- 1x kit de vis DIN 914 M6x20mm
- 1x rondelle étanche EPDM



4

Rohre, Relingsbeschläge, Scheuerleiste und Zubehör

Tubes, rail fittings, rub strakes and accessories

Tubes, embases, liston de protection et accessories

8310

Rohrendkappe / A4-AISI 316

Top cap / Embout pour tube



Artikel-Nr. Item-no.	Für Rohr-Ø For tube-Ø	iD	S	L	Box	*€/Stück *€/piece
8310419	19	6,6	7	55	10	8,90
8310420	20	6,6	7	55	10	9,00
8310422	22	6,6	7	58	10	10,00
8310425	25	6,6	7	58	10	10,70
8310430	30	8,3	7	58	5	12,30

8662

Rohrendkappe, verstärkt / A4-AISI 316

Top cap, heavy duty / Embout renforcé pour tube



Artikel-Nr. Item-no.	Für Rohr-Ø For tube-Ø	L	iD	S	Box	*€/Stück *€/piece
8662422	22	54	7,5	7	10	9,10
8662425	25	58	7,5	7	10	10,50
8662430	30	61	8,5	7	5	14,30

814781

Rohrendkappe mit 2 Schrauben / A4-AISI 316

Top cap with 2 screws / Embout pour tube avec 2 vis



Artikel-Nr. Item-no.	Für Rohr-Ø For tube-Ø	iD	S	L	Box	*€/Stück *€/piece
814781420	20	6,6	7	70	10	10,00
814781422	22	6,6	7	70	10	11,30
814781425	25	6,6	7	70	10	14,90
814781430	30	8,6	7	70	5	15,00
814781432	32	8,6	7	70	5	16,00

814782

Rohrendkappe mit 2 Schrauben, verstärkt / A4-AISI 316

Top cap with 2 screws, heavy duty / Embout renforcé pour tube avec 2 vis

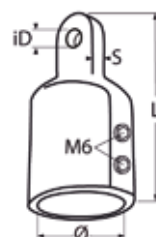

Artikel-Nr. Item-no.	Für Rohr-Ø For tube-Ø	iD	S	L	Box	*€/Stück *€/piece
814782422	22	6,5	7	62	10	12,50
814782425	25	6,5	7	62	10	13,30

Rohre, Relingsbeschläge, Scheuerleiste und Zubehör

Tubes, rail fittings, rub strakes and accessories
Tubes, embases, liston de protection et accessoires

4

Rohrverlängerung, verstärkt / A4-AISI 316

Tube extender, heavy duty / Prolongation d'embout renforcé pour tube avec 2vis

814783

Artikel-Nr. Item-no.	Für Rohr-Ø For tube-Ø	iD	S	L1	L2	Box	*€/Stück *€/piece
814783422	22	6,4	7	76	17	1	21,60
814783425	25	6,4	7	76	17	1	22,40

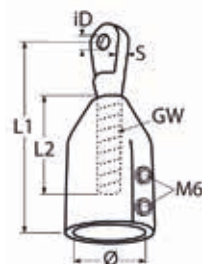

Rohrendkappe mit Lasche, 90° / A4-AISI 316

Top cap with strap, 90° / Embout pour tube avec poignee, 90°

814997

Artikel-Nr. Item-no.	Für Rohr-Ø For tube-Ø	iD	S	Box	*€/Stück *€/piece
814997422	22	6,6	7	1	11,80
814997425	25	6,6	7	1	13,80

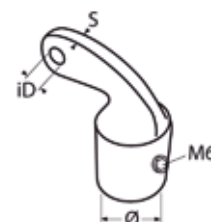

Rohrendkappe mit Gabelkopf / A4-AISI 316

Top cap with fork / Embout pour tube avec chape

814998

Artikel-Nr. Item-no.	Für Rohr-Ø For tube-Ø	ø	iB	Box	*€/Stück *€/piece
814998422	22	6	7,1	1	9,90
814998425	25	6	7,1	1	10,90



Rohrendstück, Spitze / A4-AISI 316

Tube end plug, spike / Bouchon mâle pour tube avec pointe

8216

Artikel-Nr. Item-no.	Für Rohr-Ø For tube-Ø	Box	*€/Stück *€/piece
8216419	19	10	7,00
8216420	20	10	13,60
8216422	22	10	14,00
8216425	25	10	15,50
8216430	30	5	16,00



Die Angabe "Für Rohr-Ø" gilt für Rohre mit 1,5mm Wandungsstärke.

The specification "For tube-Ø" applies to tubes with wall thickness 1.5mm.

La spécification "Pour tube-Ø" s'applique aux tubes avec une épaisseur de paroi de 1,5mm.

4

Rohre, Relingsbeschläge, Scheuerleiste und Zubehör

Tubes, rail fittings, rub strakes and accessories

Tubes, embases, liston de protection et accessoires

8327

Rohrendstück, Lasche / A4-AISI 316

Tube end plug, strap / Bouchon mâle pour tube avec poignée

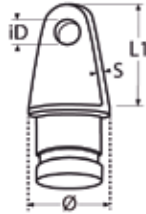

Artikel-Nr. Item-no.	Für Rohr-Ø For tube-Ø	iD	S	L1	Box	*€/Stück *€/piece
8327419	19	7,5	7	27,0	10	12,50
8327420	20	7,5	7	27,0	10	13,00
8327422	22	7,5	7	27,5	10	13,80
8327425	25	7,5	7	280	10	15,70

Die Angabe "Für Rohr-Ø" gilt für Rohre mit 1,5mm Wandungsstärke.

The specification "For tube-Ø" applies to tubes with wall thickness 1.5mm.

La spécification "Pour tube-Ø" s'applique aux tubes avec une épaisseur de paroi de 1,5mm.

8309

Rohrmittelstück / A4-AISI 316

Top slide / Collier de capote pour tube

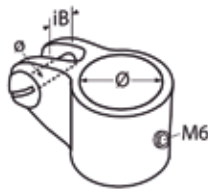

Artikel-Nr. Item-no.	Für Rohr-Ø For tube-Ø	Ø	iB	Box	*€/Stück *€/piece
8309419	19	5,2	7,7	10	8,40
8309420	20	5,2	7,7	10	9,00
8309422	22	5,2	7,7	10	10,50
8309425	25	5,2	7,7	10	10,70
8309430	30	7,1	7,7	5	12,00

8663

Rohrmittelstück, verstärkt / A4-AISI 316

Top slide, heavy duty / Collier de capote renforcé pour tube

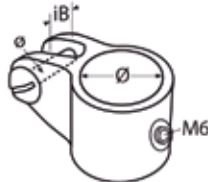

Artikel-Nr. Item-no.	Für Rohr-Ø For tube-Ø	Ø	iB	Box	*€/Stück *€/piece
8663422	22	6,0	7,5	10	13,00
8663425	25	6,0	7,5	10	13,50
8663430	30	7,1	8,0	5	15,00

814995

Rohrmittelstück mit 2 Schrauben, verstärkt / A4-AISI 316

Top slide with 2 screws, heavy duty / Collier de capote renforcé pour tube avec 2 vis

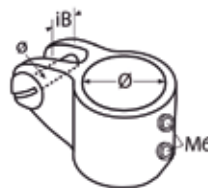

Artikel-Nr. Item-no.	Für Rohr-Ø For tube-Ø	Ø	iB	Box	*€/Stück *€/piece
814995422	22	6	7,5	10	11,30
814995425	25	6	7,5	10	12,20
814995430	30	8	7,5	10	15,20

Rohre, Relingsbeschläge, Scheuerleiste und Zubehör

Tubes, rail fittings, rub strakes and accessories
 Tubes, embases, liston de protection et accessoires

4

Rohrmittelstück mit Seitenbefestigung / A4-AISI 316 Top slide with side mount / Collier de capote pour montage latéral

8658

Artikel-Nr. Item-no.	Für Rohr-Ø For tube-Ø	ø	L	Box	*€/Stück *€/piece
8658422	22	6	30	10	20,50
8658425	25	6	30	10	23,10

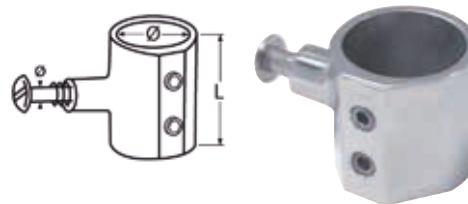

Rohrverlängerung / A4-AISI 316 Tubing extender / Prolongation d'embout pour tube

8665

Artikel-Nr. Item-no.	Für Rohr-Ø For tube-Ø	iD	S	L	L1	GW	Box	*€/Stück *€/piece
8665422	22	7	7	100	65	M16	1	15,50
8665425	25	7	7	100	65	M16	1	17,40

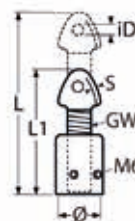

Rohrmittelstück, 2-tlg. / A4-AISI 316 Top slide, 2-part / Collier ouvrant avec goupille et charnière

8478

Artikel-Nr. Item-no.	Für Rohr-Ø For tube-Ø	ø	iB	L	B	H	GW	Box	*€/Stück *€/piece
8478422	22	6	7,5	62	30	28	M6	5	18,40
8478425	25	6	7,5	65	33	28	M6	5	18,90
8478430	30	6	7,5	72	38	28	M6	5	21,80

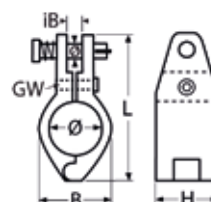

Rohrmittelstück mit Knebel, 2-tlg. / A4-AISI 316 Top slide with handle, 2-part / Collier ouvrant avec goupille, charnière et clef

814048

Artikel-Nr. Item-no.	Für Rohr-Ø For tube-Ø	ø	L	H	GW	Box	*€/Stück *€/piece	
814048422	22	6,2	59	21,5	M4	1	28,80	
814048422 ERSATZ	Ersatzknebel für 22mm / Replacement key for 22mm					M4	1	11,50
814048425	25	6,2	66	24,0	M5	1	32,00	
814048425 ERSATZ	Ersatzknebel für 25mm / Replacement key for 25mm					M5	1	12,50
814048430	30	6,2	75	25,0	M5	1	48,00	
814048430 ERSATZ	Ersatzknebel für 30mm / Replacement key for 30mm					M5	1	12,50

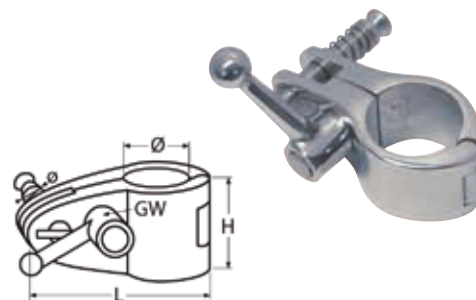

4

Rohre, Relingsbeschläge, Scheuerleiste und Zubehör

Tubes, rail fittings, rub strakes and accessories

Tubes, embases, liston de protection et accessories

8311

Verdeckbeslag / A4-AISI 316

Deck hinge / Platine de capote

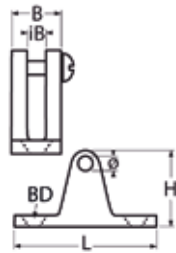

Artikel-Nr. Item-no.	ø	L	B	iB	H	BD	Box	*€/Stück *€/piece
8311456 17	5,5	56	17	7	35	5,3	5	11,20

8313

Verdeckbeslag, 80° / A4-AISI 316

Deck hinge, 80° / Platine de capote, 80°

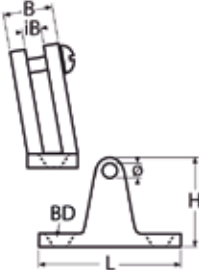

Artikel-Nr. Item-no.	ø	L	B	iB	H	BD	Box	*€/Stück *€/piece
8313456 20	5,5	56	20	7	36	5,3	5	12,00

8328

Verdeckbeslag mit Klappnasenbolzen / A4-AISI 316

Deck hinge with drop nose pin / Platine de capote avec axe à languette

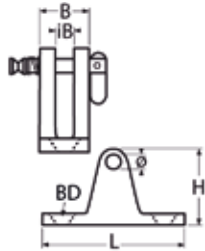

Artikel-Nr. Item-no.	ø	L	B	iB	H	BD	Box	*€/Stück *€/piece	
8328456 17	6	60	17	7	35	5,3	5	13,00	
83284ERSATZ	6	Ersatz-Klappnasenbolzen / Replacement drop nose pin						1	2,90

8856

Verdeckbeslag mit Klappnasenbolzen, 80° / A4-AISI 316

Deck hinge with drop nose pin, 80° / Platine de capote 80° avec axe à languette

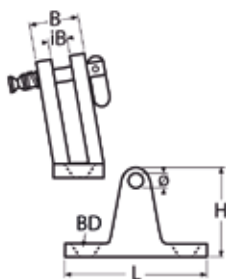

Artikel-Nr. Item-no.	ø	L	B	iB	H	BD	Box	*€/Stück *€/piece	
8856456 17	6	56	17	7	35	5,3	5	13,20	
83284ERSATZ		Ersatz-Klappnasenbolzen / Replacement drop nose pin						1	2,90

Rohre, Relingsbeschläge, Scheuerleiste und Zubehör

Tubes, rail fittings, rub strakes and accessories
 Tubes, embases, liston de protection et accessories

4

Verdeckbeschlag mit Klappnasenbolzen, konkav / A4-AISI 316

Deck hinge with drop nose pin, concave / Platine de capote concave avec axe à languette

8329

Artikel-Nr. Item-no.	Für Rohr-Ø For tube-Ø	ø	L	B	iB	H	BD	Box	*€/Stück *€/piece
8329456 17	25	6	56	17	7	35	5,3	5	13,00
83284ERSATZ	Ersatz-Klappnasenbolzen / Replacement drop nose pin							5	2,90

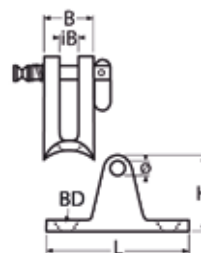

Verdeckbeschlag Seitenplatte / A4-AISI 316

Deck hinge for side mount / Platine de capote pour montage latéral

8312

Artikel-Nr. Item-no.	ø	L	B	H	H1	BD	Box	*€/Stück *€/piece
8312450 23	6	50	23	33	11,6	5,3	5	8,80

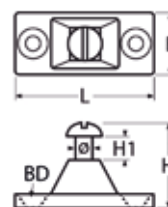

Verdeckbeschlag Seitenplatte / A4-AISI 316

Deck hinge for side mount / Platine de capote pour montage latéral

8853

Artikel-Nr. Item-no.	ø	L	B	H	S	BD	Box	*€/Stück *€/piece
8853473 48	6,2	73	48	34	4,7	7	5	23,50

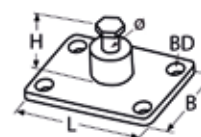

Verdeckbeschlag, Gabelkopf dreh- und abnehmbar / A4-AISI 316

Deck hinge, fork removable and turnable / Platine de capote, chape à tournante et amovible

814166

Artikel-Nr. Item-no.	ø	L	B	iB	H	BD	Box	*€/Stück *€/piece
814166475 35	4,5	75	35	7,5	43	6,4	1	35,00

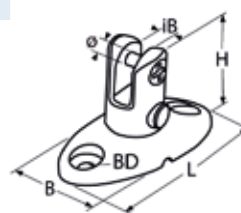

4

Rohre, Relingsbeschläge, Scheuerleiste und Zubehör

Tubes, rail fittings, rub strakes and accessories

Tubes, embases, liston de protection et accessoires

8611

Decksgelenk mit Gabelkopf / A4-AISI 316

Swivel deck hinge / Platine de capote articulée

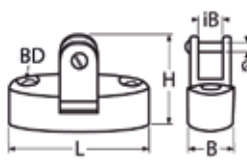

Artikel-Nr. Item-no.	ø	L	B	iB	H	BD	Box	*€/Stück *€/piece
8611425 70	5,3	70	25	7,5	45	6,4	5	20,10

8652

Bimini-Gelenk mit Steckbolzen / A4-AISI 316

Bimini-joint with fast pin / Joint bimini avec goupille

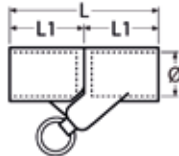

Artikel-Nr. Item-no.	Für Rohr-Ø For tube-Ø	L	L1	Box	*€/Stück *€/piece
8652422	22	78	39	1	26,00
8652425	25	80	40	1	30,00

8819

Bimini-Kugelgelenk für Rohrmontage / A4-AISI 316 / Nylon

Bimini ball joint for tube mounting / Joint bimini articulé pour installation de tuyaux

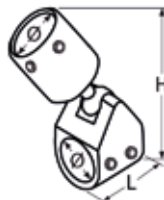

Artikel-Nr. Item-no.	Für Rohr-Ø For tube-Ø	L	H	Box	*€/Stück *€/piece
8819422	22	32	97	1	67,50
8819425	25	32	97	1	71,00

8820

Bimini-Kugelgelenk für Decksmontage / A4-AISI 316 / Nylon

Bimini ball joint for deck mounting / Joint bimini articulé avec goupille pour installation de pont den bateau



Artikel-Nr. Item-no.	Für Rohr-Ø For tube-Ø	L	B	H	Box	*€/Stück *€/piece
8820422	22	42	30	82	1	67,40
8820425	25	42	30	82	1	71,50

Rohre, Relingsbeschläge, Scheuerleiste und Zubehör

Tubes, rail fittings, rub strakes and accessories
Tubes, embases, liston de protection et accessoires

4

Biminispanner / A2-AISI 304

Adjustable bimini pole / Poteau réglable pour bimini

814116

Artikel-Nr. Item-no.	L	L1	D	iD	Box	*€/Stück *€/piece
814116289	890	820	22	7	1	104,60
814116296	960	890	22	7	1	122,50
8141162103	1030	970	22	7	1	130,00
8141162114	1140	1070	22	7	1	135,00

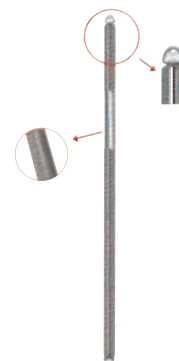
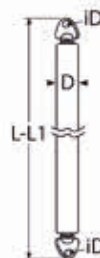

Biminispanner / A4-AISI 316

Bimini tensioner / Bimini tensioner pour tube

814808

Artikel-Nr. Item-no.	Für Rohr-Ø For tube-Ø	L	L1	S	iD	Box	*€/Stück *€/piece
814808422	22	189	138	7	6,3	1	33,00
814808425	25	189	138	7	6,3	1	41,00
814808430	30	189	138	7	6,3	1	42,00

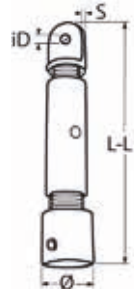

Rohrendkappe mit Kugelkopf-Gelenk / A4-AISI 316

Top cap with ball-joint / Embout pour tube à rotule

814985

Artikel-Nr. Item-no.	Für Rohr-Ø For tube-Ø	Box	*€/Stück *€/piece
814985422	22	1	49,00
814985425	25	1	50,00



Rohrendkappe mit Kugelkopf-Gelenk, 90° / A4-AISI 316

Top cap with ball-joint, 90° / Embout pour tube à rotule, 90°

814986

Artikel-Nr. Item-no.	Für Rohr-Ø For tube-Ø	Box	*€/Stück *€/piece
814986422	22	1	37,00



4

Rohre, Relingsbeschläge, Scheuerleiste und Zubehör

Tubes, rail fittings, rub strakes and accessories

Tubes, embases, liston de protection et accessories

814987

Rohrmittelstück für Kugelkopf-Gelenk / A4-AISI 316

Top slide for ball-joint / Collier de capote pour tube avec articulé



Artikel-Nr. Item-no.	Für Rohr-Ø For tube-Ø	L	Box	*€/Stück *€/piece
814987422	22	33	1	45,00
814987425	25	33	1	49,00

Montage mit Art. 814985 oder 814986

Assembly with art. 814985 or 814986

Montage avec art. 814985 ou 814986

814988

Kugelkopf-Halter für Windschutzscheibe, flach / A4-AISI 316

Windshield fitting for ball-joint, flat base / Collier de capote pour rotule, parebris plat



Artikel-Nr. Item-no.	L	Box	*€/Stück *€/piece
814988433	33	1	66,90

Montage mit Art. 814985 oder 814986

Assembly with art. 814985 or 814986

Montage avec art. 814985 ou 814986

814989

Kugelkopf-Halter für Windschutzscheibe, konkav / A4-AISI 316

Windshield fitting for ball-joint,concave base / Collier de capote pour rotule, parebris concave



Artikel-Nr. Item-no.	L	Box	*€/Stück *€/piece
814989433	33	1	72,00

Montage mit Art. 814985 oder 814986

Assembly with art. 814985 or 814986

Montage avec art. 814985 ou 814986

814990

Verdeckbeschlag für Kugelkopf, flach / A4-AISI 316

Deck hinge for ball joint, flat base / Platine de capote pour rotule, plat



Artikel-Nr. Item-no.	L	Box	*€/Stück *€/piece
814990460	60	1	48,00

Montage mit Art. 814985 oder 814986

Assembly with art. 814985 or 814986

Montage avec art. 814985 ou 814986

Rohre, Relingsbeschläge, Scheuerleiste und Zubehör

Tubes, rail fittings, rub strakes and accessories
 Tubes, embases, liston de protection et accessoires

4

Verdeckbeschlag für Kugelkopf, konkav / A4-AISI 316 Deck hinge for ball joint, concave base / Platine de capote pour rotule, concave

814991

Artikel-Nr. Item-no.	L	Box	*€/Stück *€/piece
814991460	60	1	48,00

Montage mit Art. 814985 oder 814986

Assembly with art. 814985 or 814986

Montage avec art. 814985 ou 814986



NEW

Verdeckbeschlag für Kugelkopf, mit D-Ring, flach / A4-AISI 316 Deck hinge with D-ring / Platine de capote pour rotule, avec anneau en D, plat

815150

Artikel-Nr. Item-no.	Seite Side	L	Box	*€/Stück *€/piece
815150449P	Backbord Port	49	1	82,20
815150449S	Steuerbord Starbord	49	1	82,20

Montage mit Art. 814985 oder 814986

Assembly with art. 814985 or 814986

Montage avec art. 814985 ou 814986



NEW

Verdeckbeschlag für Kugelkopf, mit D-Ring, konkav / A4-AISI 316 Concave deck hinge with D-ring / Platine de capote pour rotule, avec anneau en D, concave

815151

Artikel-Nr. Item-no.	Seite Side	L	Box	*€/Stück *€/piece
815151449P	Backbord Port	49	1	80,10
815151449S	Steuerbord Starbord	49	1	80,10

Montage mit Art. 814985 oder 814986

Assembly with art. 814985 or 814986

Montage avec art. 814985 ou 814986



Steckbolzen mit Sicherungsseil / A4-AISI 316 Plug-in pin with safety wire / Câble de sécurité avec goupille à bille

814992

Artikel-Nr. Item-no.	ø	L	L1	iD	DS-ø	Box	*€/Stück *€/piece
814992448 40	4,8	125	40	8	1,0	1	16,50

Ersatzteil für Art. 814988, 814989, 814990 oder 814991

Spare part for art. 814988, 814989, 814990 or 814991

Pièce de rechange pour art. 814988, 814989, 814990 ou 814991



4

Rohre, Relingsbeschläge, Scheuerleiste und Zubehör

Tubes, rail fittings, rub strakes and accessories

Tubes, embases, liston de protection et accessoires

814993

Kunststoff-Einlage für Kugelkopf-Gelenk / Plastik

Plastic insert for ball-joint / Insère en plastique pour rotule



Artikel-Nr. Item-no.	Box	*€/Stück *€/piece
8149933ERSATZ	1	8,70

Ersatzteil für Art. 814987, 814988, 814989, 814990 oder 814991

Spare part for art. 814988, 814988, 814989, 814990 or 814991

Pièce de rechange pour art. 814988, 814989, 814990 ou 814991

814730

Gabelkopf für Winschaufnahme / A4-AISI 316

Fork for winchDrive / Chape de fixation pour bimini

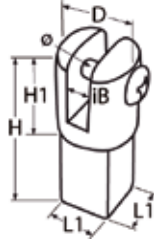

Artikel-Nr. Item-no.	ø	L1	iB	H	H1	D	Box	*€/Stück *€/piece
814730461	6	17	9	61	30	25	2	16,50

8542

Gurtbandbügel / A2-AISI 304

Strap fitting / Pontet pour sangle

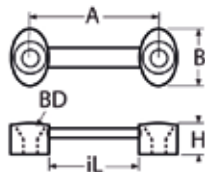

Artikel-Nr. Item-no.	A	B	iL	H	BD	Box	*€/Stück *€/piece
8542225	38	16	25	10	5	10	4,50

814207

Gurtbandbügel "Design" / A4-AISI 316

Strap fitting "Design" / Pontet pour sangle

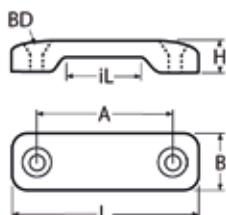

Artikel-Nr. Item-no.	L	B	iL	H	A	BD	Box	*€/Stück *€/piece
814207425	50	15	25	10	37	4,5	5	7,60

Rohre, Relingsbeschläge, Scheuerleiste und Zubehör

Tubes, rail fittings, rub strakes and accessories
 Tubes, embases, liston de protection et accessories

4

Riemenbügel / A4-AISI 316
 Webbing strap / Pontet pour sangle

8366

Artikel-Nr. Item-no.	L	iL	ø	BD	Box	*€/Stück *€/piece
8366426	68	30	5	4,5	10	5,70
8366436	75	40	5	4,5	10	5,90



Gurtbandbügel, flach, MT-Serie / A4-AISI 316
 Webbing bridge, MT series/ Pontet pour sangle, plat, Série MT

814950

Artikel-Nr. Item-no.	L	iL	B1	iH	S	BD	Box	*€/Stück *€/piece
814950425	50	25	8	3,6	1,5	5	20	1,20
814950440	70	40	8	3,6	2,0	5	20	1,60
814950450	80	50	8	3,6	2,0	5	20	1,80

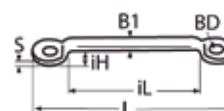

Bügeltasche versenkt / A2-AISI 304

Cover frame bracket flush mounted / Étrier pour arceaux de taud

8698

Artikel-Nr. Item-no.	L1	iL	iB	H	D	S	BD	Box	*€/Stück *€/piece
8698220 35	24	20	3,5	29	30	2	4	5	8,90

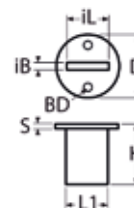

Bügeltasche / A2-AISI 304

Cover frame bracket / Étrier pour arceaux de taud et montage latéral

8699

Artikel-Nr. Item-no.	L	iL	B	iB	S	BD	Box	*€/Stück *€/piece
8699285 30	85	25	30	8	4	7,5	5	17,80

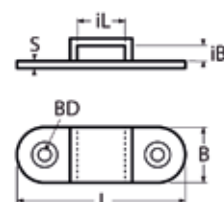

4

Rohre, Relingsbeschläge, Scheuerleiste und Zubehör

Tubes, rail fittings, rub strakes and accessories

Tubes, embases, liston de protection et accessories

8697

Bügeltasche / A2-AISI 304

Cover frame bracket / Étrier pour arceaux de taud et montage latéral

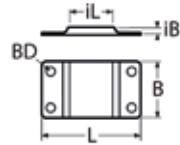
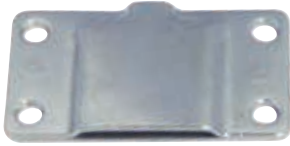

Artikel-Nr. Item-no.	L	iL	B	iB	BD	Box	*€/Stück *€/piece
8697245 25	45	20	25	1,8	4,2	5	7,90

814210

Gummiseilhalter „Persenning Knopf“ / A4-AISI 316

Norwegian knob / Bouton pour corde élastique



814210411 10



814210411 18



814210419 13

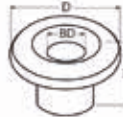

Artikel-Nr. Item-no.	D	H	BD	Für Seil-Ø For rope-Ø	Box	*€/Stück *€/piece
814210411 10	11	10	4,3	5	50	0,90
814210411 18	11	18	4,3	5	25	2,10
814210419 13	19	13	4,3	6	25	2,90

8226

Fenderöse / A2-AISI 304 / A4-AISI 316

Fender eye / Pontet

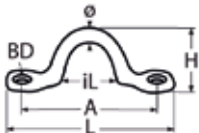

Artikel-Nr. A2 Item-no. A2	Artikel-Nr. A4 Item-no. A4	ø	L	iL	H	A	BD	Box	*€/Stück A2 *€/piece A2	*€/Stück A4 *€/piece A4
8226204	NEW 8226404	4	40	17,0	16	31	3,2	100	0,50	0,60
8226205	NEW 8226405	5	50	18,5	17	37	4,2	100	0,60	0,70
8226206	NEW 8226406	6	60	17,0	22	45	5,2	100	0,70	0,80
8226208	NEW 8226408	8	65	16,5	24	48	6,2	50	1,00	1,50
8226210	NEW 8226410	10	80	24,5	31	62	6,2	20	2,00	2,50

Rohre, Relingsbeschläge, Scheuerleiste und Zubehör

Tubes, rail fittings, rub strakes and accessories
 Tubes, embases, liston de protection et accessories

4

Fenderöse, verstärkt / A4-AISI 316
 Fender eye, heavy duty / Pontet renforcé

8227

Artikel-Nr. Item-no.	ø	L	iL	H	A	BD	Box	*€/Stück *€/piece
8227405	5	48	15,5	15	34	5,3	25	2,50

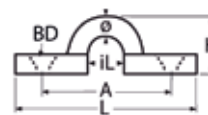

Augbügel / A4-AISI 316
 Eye strap / Pontet plat

8855

Artikel-Nr. Item-no.	L	iL	H	S	BD	Box	*€/Stück *€/piece
8855445	45	10	14	1,2	4	10	3,20
8855448	48	12	17	1,2	4	10	3,40



Augbügel mit langen Laschen / A4-AISI 316
 Eye strap with long flaps / Pontet plat longue

814658

Artikel-Nr. Item-no.	L	iL	B	H	A	A1	S	BD	Box	*€/Stück *€/piece
814658466	66	10	11	11	56,0	26,0	1,2	4,2	50	0,50
814658469	69	13	14	11	57,5	25,5	1,2	4,2	50	0,60
814658472	72	16	17	11	59,0	35,0	1,2	4,2	50	0,70

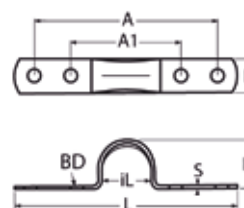

Fenderöse flach / A4-AISI 316
 Flat eye strap / Pontet plat

8860

Artikel-Nr. Item-no.	L	iL	B1	H	S	BD	Box	*€/Stück *€/piece
8860437	37	12	4	13	1,5	4,2	100	0,50
8860437B	37	12	8	13	1,5	5,0	100	0,60
8860446	46	17	6	15	2,0	5,2	100	0,70
8860456	56	24	7	21	2,0	5,2	100	1,20

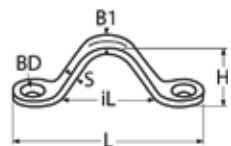

4

Rohre, Relingsbeschläge, Scheuerleiste und Zubehör

Tubes, rail fittings, rub strakes and accessories

Tubes, embases, liston de protection et accessoires

815005

Leitöse / Augbügel / A4-AISI 316

Strap eye / Filoir pour cordage

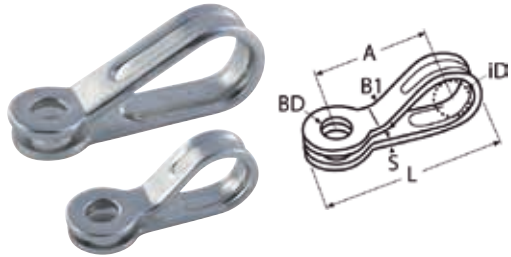

Artikel-Nr. Item-no.	L	B1	iD	A	S	BD	**BL kg	Box	*€/Stück *€/piece
815005407	25	4,7	7	15	1,5	4,2	500	20	1,80
815005409	36	7,3	9	24	2,0	5,0	1000	20	2,40

8540

Gurthaken mit Wirbel / A4-AISI 316

Swivel snap hook for strap / Mousqueton émerillon pour sangle

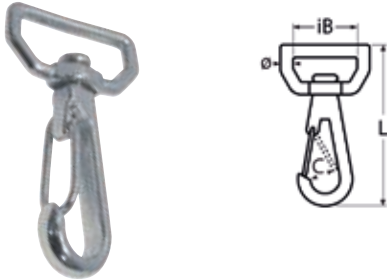

Artikel-Nr. Item-no.	L	iB	C	ø	Box	*€/Stück *€/piece
8540465 37	65	28	9	3,5	10	7,20

8541

Gurthaken mit Schnappsicherung / A2-AISI 304

Spring snap for strap / Mousqueton fixe pour sangle

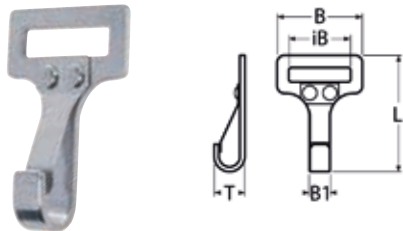

Artikel-Nr. Item-no.	L	B	B1	iB	T	Box	*€/Stück *€/piece
8541250 37	48	36	8	25	12	10	2,50

814655

Gurthaken, schwere Ausführung / A4-AISI 316

Straphook, heavy duty / Crochet double pour sangle

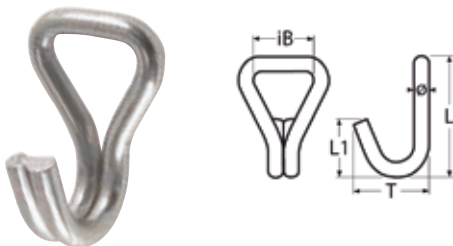

Artikel-Nr. Item-no.	ø	L	L1	iB	T	Box	*€/Stück *€/piece
814655407	7	56	27	28	35,5	10	6,40

Rohre, Relingsbeschläge, Scheuerleiste und Zubehör

Tubes, rail fittings, rub strakes and accessories
 Tubes, embases, liston de protection et accessoires

4

Gurthaken mit Schnappsicherung / A4-AISI 316 Strap hook with safety snap / Mousqueton pour sangle

814902

Artikel-Nr. Item-no.	L	iL	iB	T	C	Box	*€/Stück *€/piece
814902462	62	13,5	25	30	8	10	5,10

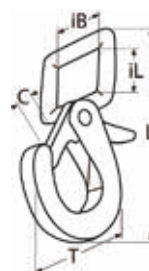

Gurtschnalle / A4-AISI 316 Webbing buckle / Passant double pour sangle

8496

Artikel-Nr. Item-no.	L	iL	B	iB	S	Box	*€/Stück *€/piece
8496462 34	62	50	34	5	3	10	2,90

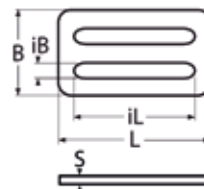

Gurtschnalle mit verzahntem Steg / A4-AISI 316 Webbing buckle with toothed bar / Passant double pour sangle avec axe denté

814955

Artikel-Nr. Item-no.	L	iL	B	S	Box	*€/Stück *€/piece
814955460 23	60	52	23,5	1,5	20	1,00

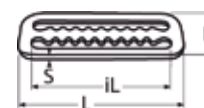

Gurtschnalle / A2-AISI 304 Webbing buckle / Passant double pour sangle

8543

Artikel-Nr. Item-no.	L	iL	B	B1	S	Box	*€/Stück *€/piece
8543225 35	35	25	25	5	3	20	1,50

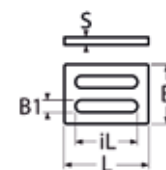

4

Rohre, Relingsbeschläge, Scheuerleiste und Zubehör

Tubes, rail fittings, rub strakes and accessories

Tubes, embases, liston de protection et accessoires

814969

Sprenger Gurtschnellverschluss / A2-AISI 304
Sprenger snap closure for strap / Sprenger boucle pour sangle



Artikel-Nr. Item-no.	L	iB	Box	*€/Stück *€/piece
814969265	65	21	1	16,40

814970

Sprenger Gurtschnellverschluss mit D-Ring / A2-AISI 304
Sprenger snap closure for strap with D-ring / Sprenger boucle pour sangle avec anneau en D

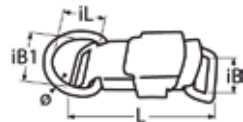

Artikel-Nr. Item-no.	L	iL	iB	iB1	ø	Box	*€/Stück *€/piece
814970265	65	19,5	21	27	4	1	20,40

814910

Gurtschnalle mit Dorn / A4-AISI 316
Webbing buckle with thorn / Passant pour sangle avec ardillon

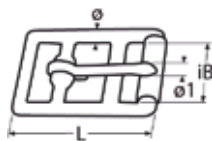

Artikel-Nr. Item-no.	L	iB	ø	ø1	Box	*€/Stück *€/piece
814910425	53	25	7,5	5,1	5	6,40

8764

Gurtschnalle mit beweglichem Steg / A2-AISI 304
Strap latch with brake / Passant pour sangle avec axe réglable

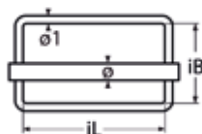

Artikel-Nr. Item-no.	iL	iB	ø	ø1	Box	*€/Stück *€/piece
8764225 25	25	25	9	4,0	10	4,60
8764243 28	40	28	9	4,5	10	7,50
8764250 30	50	30	9	4,5	10	7,80

Rohre, Relingsbeschläge, Scheuerleiste und Zubehör

Tubes, rail fittings, rub strakes and accessories
 Tubes, embases, liston de protection et accessories

4

Spanngurtverschluss / A4-AISI 316 Webbing buckle / Boucle pour sangle

8829

Artikel-Nr. Item-no.	L	iB	H	**BL kg	Box	*€/Stück *€/piece
8829425	52	25	16	1500	10	8,60

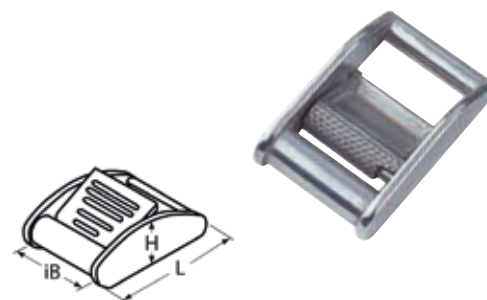

Spanngurtset / A4-AISI 316 / Nylon Strap set / Lot de 2 sangles avec 2 boucles

8823

Artikel-Nr. Item-no.	L	B	Box	*€/Stück *€/piece
8823425	2300	25	1	72,30

Set enthält zwei Spanngurte und zwei Verschlüsse.
 Set contained two straps and two buckles.
 L'ensemble contient deux sangles et deux attaches.



Batteriehaltegurt-Set / A4-AISI 316 / PES Battery strap set / Lot de sangle pour maintien de batterie

814106

Artikel-Nr. Item-no.	L	B	Box	*€/Stück *€/piece
814106496 25	960	25	1	60,60



4

Rohre, Relingsbeschläge, Scheuerleiste und Zubehör

Tubes, rail fittings, rub strakes and accessories

Tubes, embases, liston de protection et accessoires

8824

Spanngurt mit Ratsche / A2-AISI 304 / PES
Strap set with ratchet / Sangle avec crochets et tendeur



Artikel-Nr. Item-no.	L1	B	**BL kg	Box	*€/Stück *€/piece
8824225	4500	25	600	1	61,80

8814

Gurtratsche / A2-AISI 304
Ratchet buckle / Tendeur pour sangle



Artikel-Nr. Item-no.	iB	**BL kg	Box	*€/Stück *€/piece
8814225	25	800	1	19,40
8814225B	25	800	1	26,80
8814250	50	3000	1	67,00

8579

Klappauge / A2-AISI 304
Folding pad eye / Cadène articulée



Artikel-Nr. Item-no.	Ø	L	B	B1	BD	Box	*€/Stück *€/piece
8579206	6	58	55	50	7	5	10,20
8579208	8	58	55	50	7	5	14,00

815045

Klappauge / A4-AISI 316
Folding pad eye / Cadène articulée

NEW

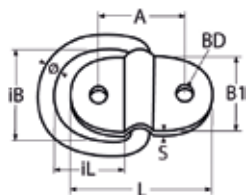

Artikel-Nr. Item-no.	Ø	L	B1	iL	iB	A	S	BD	Box	*€/Stück *€/piece
81504546 20	6	57	20	34	25	37	3	6	10	5,10
81504548 32	8	60	32	32	38	39	3	8	10	7,80

Rohre, Relingsbeschläge, Scheuerleiste und Zubehör

Tubes, rail fittings, rub strakes and accessories
 Tubes, embases, liston de protection et accessoires

4

NEW

Doppel-Klappauge mit Konterplatte / A4-AISI 316
 Double folding pad eye with counterplate / Cadène articulée double avec contreplaqué

815160

Artikel-Nr. Item-no.	∅	L	B	iB	iL	BD	Box	*€/Stück *€/piece
815160406	6	77	31	40	30	6,5	5	16,20

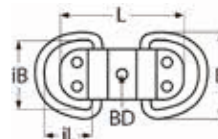

Klappauge, hochglanzpoliert, MT-Serie / A4-AISI 316 / PA
 Folding pad eye, mirror polished, MT-series / Cadène articulée, polie miroir, MT-séries

815046

NEW

Artikel-Nr. Item-no.	∅	L	B	H	iH	A	A1	BD	Box	*€/Stück *€/piece
81504646A	6	45	43	11	14	23	—	***6,4	2	15,60
81504646B	6	45	43	11	14	23	27	***6,4	2	18,00
81504646C	6	70	43	11	14	46	27	***6,4	1	27,70

***Wir empfehlen Linsensenk-Blehschrauben DIN 7983 5,5mm oder Linsensenkschrauben DIN 966 M6.

***We recommend countersunk tapping screws DIN 7983 5.5mm or countersunk screws DIN 966 M6.

***Nous recommandons des vis à tête fraisée DIN 7983 5,5mm ou vis à tête fraisée DIN 966 M6.

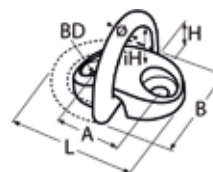

81504646A

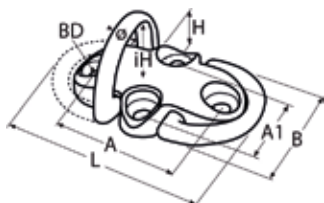

81504646C

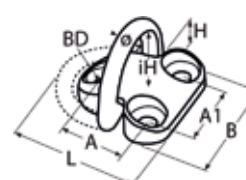

81504646B



Klappauge / A4-AISI 316
 Foldable pad eye / Cadène articulée

814662

Artikel-Nr. Item-no.	Ausführung Type	L	B	A	A1	BD	Box	*€/Stück *€/piece
8146624SINGLE	Einfach / Single	70	60	50	—	6,8	2	40,00
8146624DOUBLE	Doppelt / Double	100	60	28	25	6,8	2	67,00

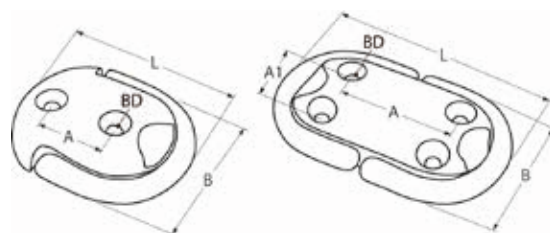

8146624DOUBLE



8146624SINGLE

4

Rohre, Relingsbeschläge, Scheuerleiste und Zubehör

Tubes, rail fittings, rub strakes and accessories

Tubes, embases, liston de protection et accessoires

8266

Mastplatte, oval / A2-AISI 304

Oval pad eye / Pontet sur platine ovale

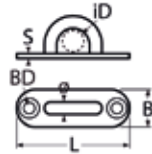

Artikel-Nr. Item-no.	ø	L	B	iD	BD	S	Box	*€/Stück *€/piece
82662045	5	45	16	11	4,5	3	10	2,50
82662065	6	60	19	14	4,5	3	10	3,80
82662081	8	80	25	19	6,2	3	10	5,00
82662100	9	100	36	24	6,2	3	10	6,00

814784

Mastplatte, oval, mit Ring / A2-AISI 304

Oval pad eye with ring / Pontet sur platine ovale avec anneau

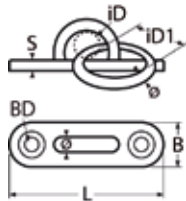

Artikel-Nr. Item-no.	ø	L	B	iD	iD1	BD	S	Box	*€/Stück *€/piece
8147842045	5	45	15	11	30	4,5	3	10	3,00
8147842060	6	60	20	14	40	4,5	3	10	4,30
8147842080	8	80	26	19	45	6,2	3	10	5,90
8147842100	9	100	32	24	50	6,2	3	10	8,80

8224

Decksplatte, oval / A4-AISI 316

Oval pad eye / Pontet sur platine ovale

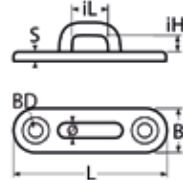

Artikel-Nr. Item-no.	ø	L	iL	B	iH	BD	S	Box	*€/Stück *€/piece
82244075	7,0	75	16	22	12,0	6,4	5,0	5	6,90
82244088	7,5	88	19	32	15,0	6,4	5,5	5	15,50
82244100	8,5	100	22	36	19,5	6,4	6,0	5	17,00

8225

Decksplatte, eckig / A2-AISI 304 / A4-AISI 316

Square pad eye / Pontet sur platine rectangulaire

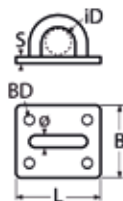

Artikel-Nr. A2 Item-no. A2	Artikel-Nr. A4 Item-no. A4	ø	L	B	iD	BD	S	Box	*€/Stück A2 *€/piece A2	*€/Stück A4 *€/piece A4
8225205	NEW 8225405	5	35	30	12	4,5	3,0	10	1,70	1,80
8225206	NEW 8225406	6	40	35	17	4,5	3,0	10	2,20	2,40
8225208	NEW 8225408	8	50	40	21	6,2	3,0	10	2,70	2,90
8225210	NEW 8225410	10	60	50	26	4,0	6,4	5	3,10	4,70

Rohre, Relingsbeschläge, Scheuerleiste und Zubehör

Tubes, rail fittings, rub strakes and accessories
 Tubes, embases, liston de protection et accessoires

4

Deckplatte, eckig mit Ring / A4-AISI 316

Square pad eye with ring / Pontet sur platine rectangulaire avec anneau

814788

Artikel-Nr. Item-no.	ø	L	B	iD	iD1	S	BD	Box	*€/Stück *€/piece
814788405	5	35	30	12	30	3	4,5	10	2,50
814788406	6	40	35	17	35	3	4,5	10	3,40
814788408	8	50	40	20	45	3	6,2	10	5,60

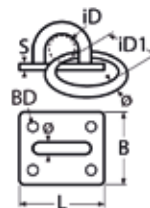

Augplatte, eckig mit Wirbel / A4-AISI 316

Square plate with swivel eye / Pontet sur platine rectangulaire avec émerillon

8396

Artikel-Nr. Item-no.	ø	L	B	iD	H	BD	Box	*€/Stück *€/piece
839645	5	35	35	15	33	4,4	10	3,20 NEW
839646	6	40	40	18	40	4,4	10	4,50 NEW
839648	8	50	50	19	44	6,0	10	7,00 NEW

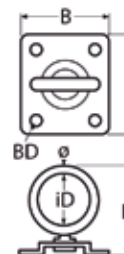

Augplatte, eckig, mit Wirbel und Ring / A4-AISI 316

Square plate with swivel eye and ring / Pontet sur platine rect. avec émerillon et anneau

8397

Artikel-Nr. Item-no.	ø	ø1	L	B	H	iD	iD1	BD	Box	*€/Stück *€/piece
839745	5	5	35	35	33	15	30	4,4	10	6,00 NEW
839746	6	6	40	40	40	18	36	4,4	10	7,00 NEW
839748	8	8	50	50	44	19	47	6,0	10	9,00 NEW

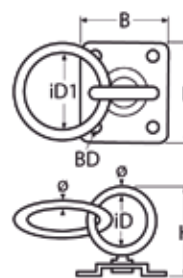

Mastplatte, gewölbt / A2-AISI 304

Mast plate, concave / Pontet sur platine concave

8365

Artikel-Nr. Item-no.	ø	L	B	iD	BD	Box	*€/Stück *€/piece
83652465 42	6	46,5	42	20	5	10	5,60
8365251 39	6	51,0	39	20	5	10	5,60

Für Mastdurchmesser ca.60-70mm.
For mast diameter about 60-70mm.
Pour diamètres de mât env. 60-70mm.

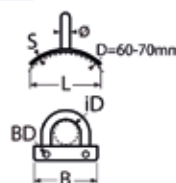

4

Rohre, Relingsbeschläge, Scheuerleiste und Zubehör

Tubes, rail fittings, rub strakes and accessories

Tubes, embases, liston de protection et accessoires

8264

Mastplatte, Raute / A2-AISI 304

Diamond pad eye / Pontet sur platine losange

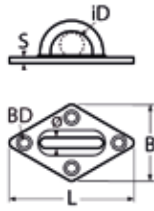

Artikel-Nr. Item-no.	ø	L	B	iD	BD	S	Box	*€/Stück *€/piece
8264205	5	60	36	13	4,5	3	10	4,00
8264206	6	65	40	16	4,5	3	10	4,50
8264208	8	80	50	19	6,2	3	10	5,80

8265

Mastplatte, Raute, mit Ring / A2-AISI 304

Diamond pad eye with ring / Pontet sur platine losange avec anneau

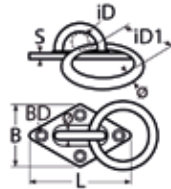

Artikel-Nr. Item-no.	ø	L	B	iD	iD1	BD	S	Box	*€/Stück *€/piece
8265205	5	60	36	13	30	4,5	3	10	5,20
8265206	6	65	40	16	35	4,5	3	10	6,20
8265208	8	80	50	19	45	6,2	3	10	9,00

8223

Decksplatte, Raute / A4-AISI 316

Diamond pad eye / Pontet sur platine losange

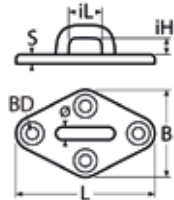
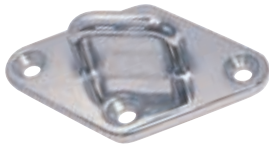

Artikel-Nr. Item-no.	ø	L	iL	B	iH	BD	S	Box	*€/Stück *€/piece
82234080	7,0	80	19	50	11	6,4	4,5	5	9,30
82234090	7,5	90	22	55	13	6,4	5,0	5	14,00
82234100	8,5	100	25	62	16	6,4	5,5	5	21,60

815131

Duplex Decksplatte Raute, MT-Serie / D6-AISI 318 LN

Duplex diamond pad eye, MT-series / Pontet sur platine losange en Duplex, MT-série



NEW

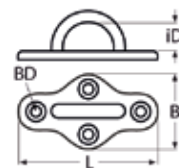

Artikel-Nr. Item-no.	ø	L	B	BD	Box	*€/Stück *€/piece
815131446263	8	63	40	5,3	5	15,20
815131446281	10	81	52	6,4	5	23,80
8151314462100	12	100	59	8,4	5	36,60

Rohre, Relingsbeschläge, Scheuerleiste und Zubehör

Tubes, rail fittings, rub strakes and accessories
 Tubes, embases, liston de protection et accessories

4



Grundplatte mit Ringmutter, MT-Serie / A4-AISI 316 Groundplate with eye nut, MT-series / Plaque de base avec écrou annulaire, MT-série

815053

NEW

Artikel-Nr. Item-no.	ø	L	B	H	iD	S	A	BD	Box	*€/Stück *€/piece
815053408	8	75	36	43	20	7	50	8,5	5	8,00

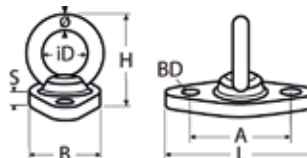

Grundplatte mit Rundschäkel, MT-Serie / A4-AISI 316 Groundplate with D-shackle, MT-series / Plaque de base avec manille, MT-série

815054

NEW

Artikel-Nr. Item-no.	ø	L	B	H	iB	iH	S	A	BD	Box	*€/Stück *€/piece
815054408	8	75	36	51	16	28	7	50	8,5	5	8,90

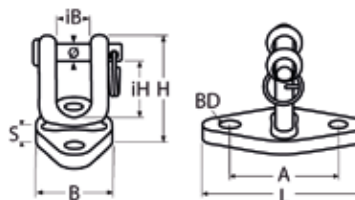

Grundplatte mit Lasche, MT-Serie / A4-AISI 316 Groundplate with strap, MT-series / Plaque de base avec support, MT-série

815063

NEW

Artikel-Nr. Item-no.	iD	L	B	B1	H	H1	S	A	BD	Box	*€/Stück *€/piece
815063406	6,5	65	27	8	23	14	5	42	6,5	10	5,00
815063408	8,5	75	36	12	31	19	7	50	8,5	5	8,50
815063410	10,5	85	45	16	39	24	9	58	10,5	5	17,00
815063413	13,5	100	54	20	47	29	11	68	12,5	2	29,00

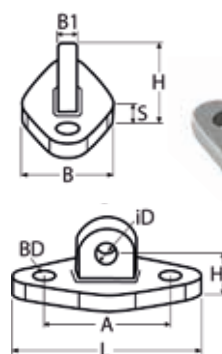

Zur Aufhängung an der Lasche empfehlen wir passende Schäkel und Wirbel aus Kapitel 1.

For suspension from the strap we recommend suitable shackles and swivels from chapter 1.

Pour la suspension au support, nous recommandons les manilles et les émerillons appropriées du chapitre 1.



Grundplatte mit Wirbelschäkel, MT-Serie / A4-AISI 316 / PA Groundplate with swivel shackle, MT-series / Plaque de base avec emerillon manille, MT-série

815052

NEW

Artikel-Nr. Item-no.	ø	L	B1	H	H1	S	A	BD	Antrieb Drive	Box	*€/Stück *€/piece
815052408	8	70	42	92	27	3	36	8,5	SW13	5	14,00

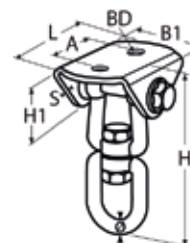

4

Rohre, Relingsbeschläge, Scheuerleiste und Zubehör

Tubes, rail fittings, rub strakes and accessories

Tubes, embases, liston de protection et accessoires

8353

Augplatte, rund / A2-AISI 304 / A4-AISI 316

Round eye plate / Pontet sur platine ronde



Artikel-Nr. A2 Item-no. A2	Artikel-Nr. A4 Item-no. A4	ø	D	A	H	iD	BD	S	Box	*€/Stück A2 *€/piece A2	*€/Stück A4 *€/piece A4
835325	NEW 835345	5	33	19,5	20	12	4,2	3	10	2,20	2,90
835326	NEW 835346	6	40	23,0	26	17	4,2	3	10	2,50	3,30
835328	NEW 835348	8	50	29,5	32	20	5,2	3	10	3,30	4,30

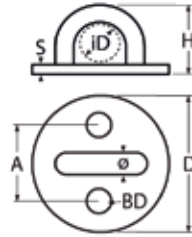

8368

Augplatte, rund, mit Gewinde / A2-AISI 304

Round eye plate with thread / Pontet sur platine ronde avec tige filetée

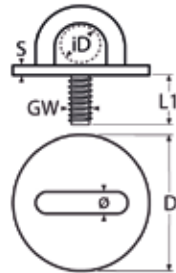

Artikel-Nr. Item-no.	GW	ø	L1	D	iD	S	Box	*€/Stück *€/piece
836825	M6	5	20	33	12	3	10	2,70
836826	M8	6	23	40	17	3	10	3,30
836828	M10	8	25	50	20	3	10	3,90

814785

Augplatte, rund, mit Gewinde und Ring / A2-AISI 304

Round eye plate with thread and ring / Pontet sur platine ronde, tige filetée et anneau

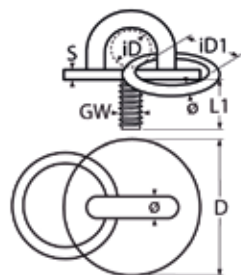

Artikel-Nr. Item-no.	GW	ø	L1	D	iD	S	Box	*€/Stück *€/piece
81478525	M6	5	20	33	12	3	10	4,00
81478526	M8	6	26	40	17	3	10	4,60
81478528	M10	8	30	50	20	3	10	8,60

8972

Hakenplatte, rund / A4-AISI 316

Round hook plate / Pontet sur platine ovale avec crochet

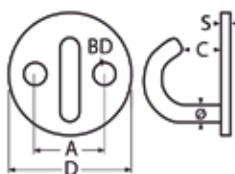

Artikel-Nr. Item-no.	ø	D	C	A	S	BD	Box	*€/Stück *€/piece
8972405	5	33	8	19	3	4,5	10	2,10
8972406	6	40	12	23	3	4,5	10	2,50
8972408	8	50	14	29	3	5,5	10	4,30

Rohre, Relingsbeschläge, Scheuerleiste und Zubehör

Tubes, rail fittings, rub strakes and accessories
 Tubes, embases, liston de protection et accessories

4

Hakenplatte, oval / A4-AISI 316
 Hook plate, oval / Pontet crochet sur platine

814657

Artikel-Nr. Item-no.	ø	L	B	A	C	BD	S	Box	*€/Stück *€/piece
814657405	5	54	16	38	8	5,0	3,6	10	2,30
814657406	6	65	19	46	12	5,5	4,0	10	2,50
814657408	8	81	26	55	13	6,4	4,5	10	4,30
814657409	9	100	32	62	16	5,7	8,3	10	7,20

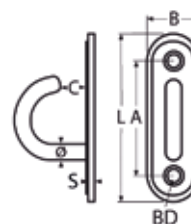

Augverschluss, versenkt / A4-AISI 316
 Swivel locking eye / Couvercle à oeil droit

814117

Artikel-Nr. Item-no.	ø	L	B	D	iD	H1	S	BD	Box	*€/Stück *€/piece
814117444	5	44	22	12	10	14	3	6,1	5	24,00

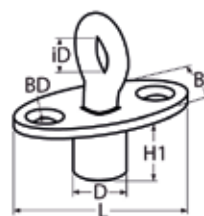

Augverschluss, versenkt, 90° / A4-AISI 316
 Swivel locking eye, 90° / Couvercle à oeil avec angle 90°

814118

Artikel-Nr. Item-no.	ø	L	B	D	iD	H1	S	BD	Box	*€/Stück *€/piece
814118444	5	44	22	12	10	14	3	6,1	5	26,10

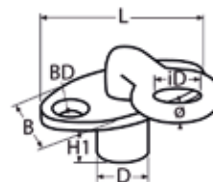

4

Rohre, Relingsbeschläge, Scheuerleiste und Zubehör

Tubes, rail fittings, rub strakes and accessories

Tubes, embases, liston de protection et accessories

8263

Scheuerleiste, halbrund, massiv / A4-AISI 316

Rub strakes, half-round, full material / Liston de protection demi-rond et massif

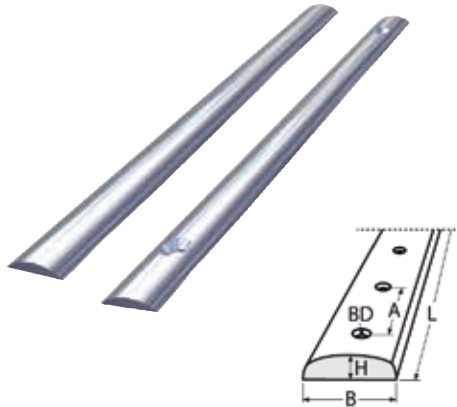

Artikel-Nr. Item-no.	L	B	H	A	BD	Ausführung Type	Box	*€/m
8263410 35POL	3000	10	3,5	–	–	poliert ¹	1	25,00
8263410 35GEB	3000	10	3,5	122	3,0	poliert+gebohrt ²	1	58,00
8263414 4POL	3000	14	4,0	–	–	poliert ¹	1	30,50
8263414 4GEB	3000	14	4,0	122	3,0	poliert+gebohrt ²	1	50,50
8263420 4POL	3000	20	4,0	–	–	poliert ¹	1	37,50
8263420 4GEB	3000	20	4,0	150	3,0	poliert+gebohrt ²	1	57,50
8263430 9POL	3000	30	9,0	–	–	poliert ¹	1	171,00
8263430 9GEB	3000	30	9,0	200	4,5	poliert+gebohrt ²	1	213,00

¹ polished / ¹ Poli,

² polished and drilled / ² Poli et percé

814100

Scheuerleiste, flach, massiv / A4-AISI 316

Rub strakes flat, full material / Liston de protection plat et massif

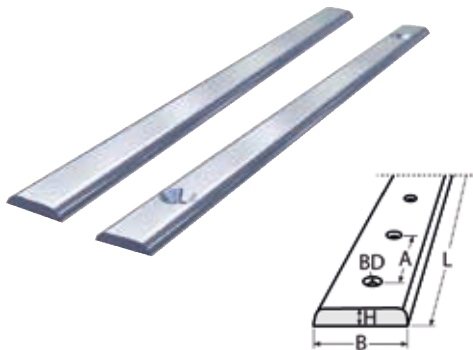

Artikel-Nr. Item-no.	L	B	H	A	BD	Ausführung Type	Box	*€/m
814100414P	3000	14	4	–	–	poliert ¹	1	42,20
814100414PG	3000	14	4	150	3,8	poliert+gebohrt ²	1	75,10
814100420P	3000	20	4	–	–	poliert ¹	1	53,00
814100420PG	3000	20	4	150	4,5	poliert+gebohrt ²	1	76,00

¹ polished / ¹ Poli,

² polished and drilled / ² Poli et percé

814601

Scheuerleiste, halbrund, hohl / A4-AISI 316

Rub strake, half round, hollow / Liston de protection demi-rond et creux



Artikel-Nr. Item-no.	L	B	A	H	BD	S	Ausführung Type	Box	*€/m
814601419	3000	19	147	6	5,8	2	poliert+gebohrt ²	1	30,50
NEW 814601419UG	3000	19	–	6	–	2	poliert ¹	1	23,15
814601425	3000	25	147	6	7,0	2	poliert+gebohrt ²	1	41,70
NEW 814601425UG	3000	25	–	6	–	2	poliert ¹	1	27,00
814601432	3000	32	147	8	7,0	2	poliert+gebohrt ²	1	48,40
NEW 814601432UG	3000	32	–	8	–	2	poliert ¹	1	36,10
NEW 814601438	3000	38	147	10	7,0	2	poliert+gebohrt ²	1	57,90
NEW 814601438UG	3000	38	–	10	–	2	poliert ¹	1	54,00

UG = ohne Bohrung / undrilled

¹ polished / ¹ Poli,

² polished and drilled / ² Poli et percé

Rohre, Relingsbeschläge, Scheuerleiste und Zubehör

Tubes, rail fittings, rub strakes and accessories
 Tubes, embases, liston de protection et accessoires

4

Scheuerleistenendstück / A4-AISI 316 Rub end cap / Embout de liston de protection

814115

Artikel-Nr. Item-no.	L	B	H	BD	Box	*€/Stück *€/piece
814115445	60	45	19	5,5	2	12,70
814115447	60	47	19	5,5	2	14,30
814115457	73	57	25	5,5	2	22,40

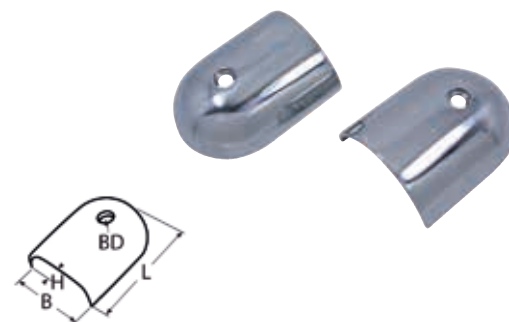

Kratzerstop, halbrund und hohl / A4-AISI 316

Rub strake, half-round and hollow / Liston de protection demi-rond et creux

8439

Artikel-Nr. Item-no.	L	B	A	BD	Box	*€/Stück *€/piece
84394200	200	20	112	6,6	5	9,00
84394200 25	200	25	118	6,5	5	10,00
84394300	300	20	107	6,5	5	11,00
84394300 25	300	25	107	7,1	5	12,00
84394450	450	20	120	6,3	5	14,00
84394450 25	450	25	120	7,9	5	15,00
84394600	600	20	127	5,9	5	17,60
84394600 25	600	25	127	7,3	5	18,50

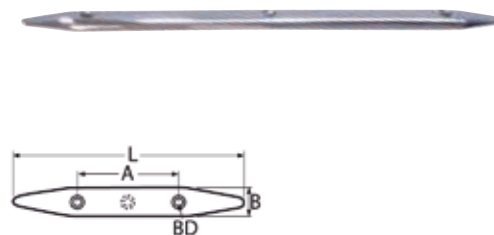

Kratzerstop, halbrund und massiv / A4-AISI 316

Rub strake, half round, full material / Liston de protection demi-rond et massif

8440

Artikel-Nr. Item-no.	L	B	A	BD	Box	*€/Stück *€/piece
84404150	150	13	120	4,5	5	6,90
84404250	250	13	110	4,5	5	9,30
84404350	350	13	160	4,5	5	13,10
84404450	450	13	140	4,5	2	15,80
84404600	600	13	114	4,5	2	20,40



Wir empfehlen Linsensenk-Blechsrauben DIN 7983 3,5mm.
 We recommend raised countersunk tapping screws DIN 7983 3.5mm.
 Nous recommandons des vis à tôle fraisée bombée DIN 7983 3,5mm.

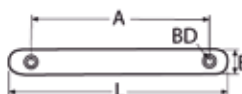



Ketten und Verbinder

Chains and connectors

Chaînes, maillons rapides et jonctions

Kapitel 5

Chapter 5



Ketten

Chains
Chaînes



Kettenzubehör

Chain accessories
Chaînes accessories



Anker und Wirbel

Anchors and swivels
Ancres et émerillons



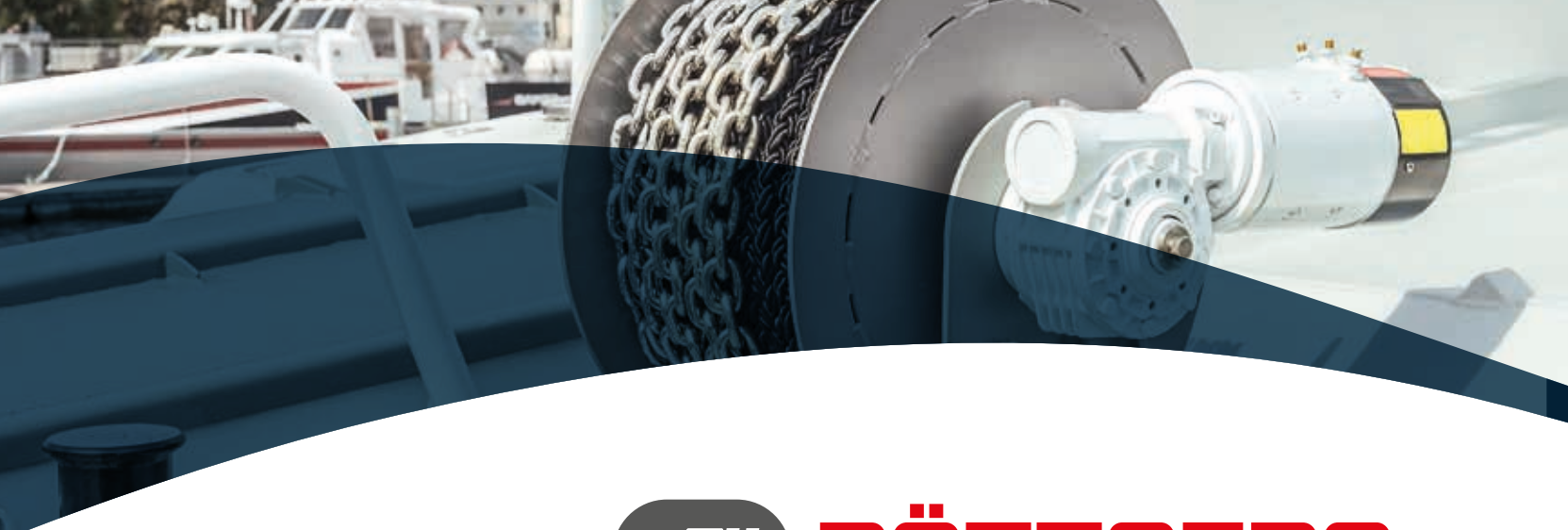

Ankerketten

Made in Germany – seit 1919

Röttgers Ketten ist ein familiengeführtes Unternehmen in der vierten Generation und zählt weltweit zu den führenden Spezialisten für hochfeste und korrosionsbeständige Rundstahlketten. Seit über 100 Jahren vertrauen anspruchsvolle Anwender der hohen Qualität und Zuverlässigkeit von Röttgers Ketten. **Höchste Bruchsicherheit und herausragende Korrosionsbeständigkeit** machen Ketten von Röttgers zur ersten Wahl im Premiumsegment – Qualität Made in Germany.



Mit ROXMA Ankerketten des deutschen Edelstahlkettenspezialisten gehen Sie in allen Gewässern jederzeit sicher vor Anker. Die Premium-Rundstahlketten erfüllen höchste

Anforderungen an Langlebigkeit, Bruchsicherheit und Korrosionsbeständigkeit. Jede Kette ist zur eindeutigen Rückverfolgbarkeit mit dem ROXMA-Logo, Germany und einem ID-Code gestempelt. Bei der Kettenfertigung erfolgt eine permanente Überwachung und Prüfung der Schweißnähte aller Glieder, sodass alle Ketten geprüft an die Kunden ausgeliefert werden. Die präzise und fachgerechte Verarbeitung gewährleistet hohe Tragfähigkeiten und Bruchlasten, bei gleichzeitig hohen Dehnwerten. Die hohe Verarbeitungsqualität der Schweißnähte bietet keinerlei Angriffspunkte für Spaltkorrosion.





Anchor chains made in Germany – since 1919

Röttgers Ketten is a family-run company that is one of the leading specialists for high-tensile round steel chains worldwide. High load capacities, breakage resistance and outstanding corrosion resistance make chains from Röttgers the first choice in the premium segment. The precise processing guarantees high elongation values. Each chain is stamped with the ROXMA logo, Germany and an ID code for traceability.

Chaînes d'ancre made in Germany – depuis 1919

Röttgers Ketten est une entreprise familiale qui est l'un des principaux spécialistes mondiaux des chaînes en acier rond à haute résistance. Les capacités de charge élevées, la résistance à la rupture et l'excellente résistance à la corrosion font des chaînes de Röttgers le premier choix dans le segment haut de gamme. Le traitement précis garantit des valeurs d'allongement élevées. Chaque chaîne est estampillée du logo ROXMA, Allemagne et d'un code d'identification pour la traçabilité.

Cadenas de anclaje hecho en Alemania – desde 1919

Röttgers Ketten es una empresa familiar que es uno de los principales especialistas en cadenas de acero redondo de alta resistencia en todo el mundo. Las altas capacidades de carga, la resistencia a la rotura y la extraordinaria resistencia a la corrosión hacen que las cadenas de Röttgers sean la primera opción en el segmento premium. El procesamiento preciso garantiza altos valores de elongación. Cada cadena está estampada con el logo de ROXMA, Alemania y un código de identificación para su rastreo.

Łańcuchy kotwiczne made in Germany – since 1919

Röttgers Ketten jest firmą rodzinną, która jest jednym z wiodących specjalistów w dziedzinie łańcuchów ze stali okrągłej o wysokiej wytrzymałości na rozciąganie na całym świecie. Wysoka nośność, odporność na pęknięcia i wyjątkowa odporność na korozję sprawiają, że łańcuchy firmy Röttgers są pierwszym wyborem w segmencie premium. Precyzyjna obróbka gwarantuje wysokie wartości wydłużenia. Każdy łańcuch jest oznakowany logo ROXMA w Niemczech oraz kodem identyfikacyjnym umożliwiającym identyfikowalność.

ROXMA duplex premium

Zwei Phasen für Stärke und Korrosionsbeständigkeit / Two phases for strength and corrosion resistance



Duplexstahl kombiniert mit seinem zweiphasigen Gefüge die Stärken von Austeniten und Ferriten in einem Produkt.

Durch das ausgewogene Mischgefüge bietet die **ROXMA duplex premium** eine starke Kombination aus Festigkeit und Korrosionsbeständigkeit (PREN min. 35). Die präzise verarbeitete und vollständig geschlossene Schweißnaht sorgt für hohe Dehnwerte und bietet keinerlei Angriffspunkte für Spaltkorrosion.

ROXMA duplex premium Ankerketten eignen sich durch die herausragenden Eigenschaften ideal für den Einsatz unter extremen Bedingungen. Insbesondere sind die **ROXMA duplex premium** für den anspruchsvollen Einsatz in warmen Gewässern bis 35 Grad Celsius sehr gut geeignet.

Duplex steel with its two-phase structure combines the strengths of austenites and ferrites in one product.

Due to the balanced mixed structure, the **ROXMA duplex premium** offers a strong combination of strength and corrosion resistance (PREN min. 35). The precisely processed and completely closed weld seam ensures high expansion values and offers no points of attack for crevice corrosion.

ROXMA duplex premium anchor chains are ideal for use under extreme conditions due to their outstanding properties. In particular, the **ROXMA duplex premium** are very well suited for demanding use in warm waters up to 35 degrees Celsius.

Technische Eigenschaften / Technical information

Material-Ø	A4 AISI-316 1.4401 Standard **BL kg	A4L AISI-316 L 1.4404 ROXMA **BL kg	Duplex D6 AISI-318 LN 1.4462 ROXMA **BL kg
6mm	1630	3000	3850
8mm	3000	5300	6700
10mm	4890	8500	10800
12mm	7200	11300	14000
13mm	8000	12500	18000
14mm	9500	15400	21000
16mm	12500	20000	26000

Material	PREN	Korrosionsschutzklasse Corrosion Resistance Class	Korrosionsbeständigkeit Corrosion Resistance
A2 AISI-304	17,5	CRC II	Gering / Low
A4L AISI-316 L	23,1 - 28,35	CRC III	Mittel / Medium
Duplex D6 AISI-318 LN	30,85 - 38,07	CRC IV	Hoch / High
ROXMA Duplex	mind. 35	CRC IV	Hoch / High
Super Duplex	37,1 - 44	CRC V	Sehr Hoch / Very High

Vorteile bei Duplex / AISI-318 LN



- Höhere Korrosionsbeständigkeit (PREN bis zu 38,07) meerwasserbeständig
- Geringes Gewicht; durch die hohe Bruchlast kann ein geringerer Kettendurchmesser verwendet werden
- Verschleißfest
- Für alle Gewässer geeignet auch meerwasserbeständig in warmen Gewässern bis 35°C
- Aufgrund der sehr glatten Oberfläche verteilt die Kette sich gleichmäßig und reibungslos im Kettenkasten

Advantage with Duplex / AISI-318 LN



- Higher corrosion resistance (PREN up to 38.07) sea water resistant
- Light weight Due to the high breaking load, a smaller chain diameter can be selected
- Wear-resistant
- Suitable for all kind of water, also seawater resistant in warm waters up to 35° C
- Due to the very smooth surface, the chain distributes evenly and smoothly in the chain case



Grundsätzlich ist in Salzwasser mindestens eine A4 Edelmetallgüte zu empfehlen. In dem gekennzeichneten Bereich können die Wassertemperaturen deutlich über 27°C steigen. In diesem Fall empfehlen wir aufgrund der deutlich höheren Korrosionsbeständigkeit die **ROXMA duplex premium**.

Basically, at least A4 stainless steel grade is recommended in salt water. In the marked area, water temperatures can rise well above 27 °C. In this case, we recommend the **ROXMA duplex premium** due to its significantly higher corrosion resistance.

Empfehlung für den Einsatz in warmen Gewässern **ROXMA duplex premium**

Recommendation for use in warm waters **ROXMA duplex premium**

ROXMA® Rundstahlkette kurzglied, maßl. DIN 766 / A4L-AISI 316 L / Duplex D6-AISI-318 LN

Chain short-link, similar to DIN 766 / Chaîne maillon court similaire à DIN 766, made in Germany

8240

Artikel-Nr. A4L Item-no. A4L	Artikel-Nr. Duplex Item-no. Duplex	Ø	iL	B	Bund m Bundle m	**BL kg A4L	Al kg A4L	**BL kg Duplex	Al kg Duplex	*€/m A4L	*€/m Duplex
8240406	8240446206	6	18,5	20	1	3000	750	3850	900	39,50	47,00
8240408	8240446208	8	24,0	26	1	5300	1250	6700	1600	64,00	76,00
8240410	8240446210	10	28,0	34	1	8500	2000	10500	2500	102,00	122,00
8240413	8240446213	13	36,0	44	1	12500	3200	18000	4250	173,50	203,00
8240414	8240446214	14	41,0	50	1	15400	3850	21000	5000	227,00	266,00
8240416	8240446216	16	45,0	53	1	20000	5000	26000	6300	286,00	339,00

Die Kette ist gebeizt und glänzend passiviert. / The chain is pickled and glossy passivated. / La chaîne est décapée et brillant passivé.

Bund: Länge auf Kundenwunsch lieferbar / Bundle: Length available on customer request / Bund: Longueur disponible sur demande du client

A4L AISI-316 L = 1.4404 / Duplex D6-AISI 318LN = 1.4462

Weitere Abmessungen/Materialien auf Anfrage möglich: ø3-18mm
Other dimensions / materials are possible on request: ø3-18mm
Autres dimensions / matériaux sont possibles sur demande: ø3-18mm

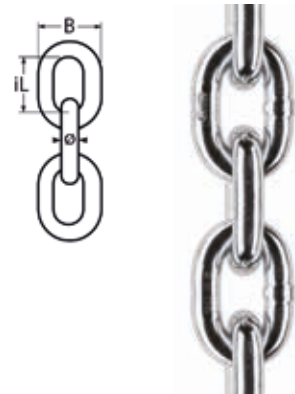

ROXMA® Rundstahlkette kurzglied, maßl. ISO 4565 / A4L-AISI 316 L / Duplex D6-AISI-318 LN

Chain short-link, similar to ISO 4565 / Chaîne maillon court similaire à ISO 4565

8315

Artikel-Nr. A4L Item-no. A4L	Artikel-Nr. Duplex Item-no. Duplex	Ø	iL	B	Bund m Bundle m	**BL kg A4L	Al kg A4L	**BL kg Duplex	Al kg Duplex	*€/m A4L	*€/m Duplex
8315406	8315446206	6	18	20,9	1	3000	750	3850	900	40,00	48,50
8315408	8315446208	8	24	27,8	1	5300	1250	6700	1600	66,00	78,50
8315410	8315446210	10	30	35,0	1	8500	2000	10500	2500	100,00	120,00
8315412	8315446212	12	36	42,0	1	11300	2800	14000	3400	142,50	167,00
8315416	8315446216	16***	48	54,0	1	20000	5000	26000	6300	287,00	339,00

Die Kette ist gebeizt und plänzend passiviert. / The chain is pickled and glossy passivated. / La chaîne est décapée et brillant passivé.

Bund: Länge auf Kundenwunsch lieferbar / Bundle: Length available on customer request / Bund: Longueur disponible sur demande du client

***16mm = ähnlich EN818-2 / AS2321 / ***16mm = Similar to EN818-2 / AS2321 / ***16mm = Similaires à EN818-2/AS2321

A4L AISI-316 L = 1.4404 / Duplex D6-AISI 318LN = 1.4462

Oberfläche: Gebeizt und glänzend passiviert

Ferritische und nichtmetallische Mikropartikel können bei unbehandeltem Edelstahl der Ausgangspunkt für eine Korrosion sein, da sie die lückenlose Bildung der Passivschicht verhindern. Eine gebeizte und glänzend passivierte Oberfläche eliminiert diese Fehlerquelle. Im Beizprozess werden sämtliche Rückstände auf der Oberfläche entfernt. Im Anschluss wird die Oberfläche glänzend passiviert, hierbei bildet sich in einem kontrollierten Prozess eine lückenlose Passivschicht. Die Korrosionsbeständigkeit ist somit deutlich erhöht.

Surface: stained and glossy passivated

Ferritic and non-metallic microparticles can be the starting point for corrosion in untreated stainless steel, as they prevent the seamless formation of the passive layer. A stained and glossy passivated surface eliminates this source of error. All residues on the surface are removed in the pickling process. The surface is then passivated with a glossy finish, a continuous passive layer is formed in a controlled process. The corrosion resistance is thus significantly increased.

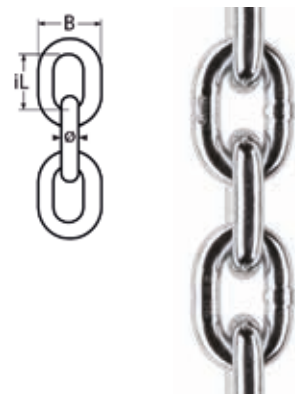

Ketten und Verbinder

Chains and connectors

Chaînes, maillons rapides et jonctions

8300

Rundstahlkette kurzglied, ähnlich DIN 766 / A2-AISI 304 / A4-AISI 316

Chain short-link, similar to DIN 766 / Chaîne maillon court similaire à DIN 766



Artikel-Nr. A2 Item-no. A2	Artikel-Nr. A4 Item-no. A4	ø	iL	B	**BL kg	Bund m A2 Bundle m A2	Bund m A4 Bundle m A4	*€/m A2	*€/m A4
8300202	8300402	2***	12,0	8,0	200	100	100	2,70	3,80
8300203	8300403	3***	16,0	11,0	440	100	100	3,40	4,50
8300204	8300404	4	16,0	13,6	770	50	30/50/100	6,80	9,20
8300205	8300405	5	18,5	17,0	1180	50	30/50/100	10,30	14,60
8300206	8300406	6	18,5	20,0	1630	50/100	30/50/100/600	15,10	18,40
–	8300407	7	22,0	23,0	2440	–	50	–	33,00
8300208	8300408	8	24,0	26,0	3000	50/100	30/50/100/400	26,40	36,10
8300210	8300410	10	28,0	34,0	4890	50/100	30/50/60/100/250	42,80	59,20
–	8300413	13	36,0	42,0	8000	–	50/150	–	100,00
–	8300416	16	45,0	51,0	12500	–	1	–	143,70

*** Ähnlich DIN 5685A.

*** Similar to DIN 5685A.

*** Similaires à DIN 5685A.

Kette kalibriert und lehrenhaltig

Chain calibrated and true to gauge

Chaîne calibrée et conforme au gabarit



Diese Ketten dürfen nicht als Lastaufnahmemittel, Anschlagmittel oder Tragmittel in Verbindung mit Hebezeugen verwendet werden!

Don't use these chains as load suspension devices or slinging devices in connection with hoists.

Ces chaînes ne doivent pas être utilisées comme dispositifs de levage, élingues ou comme dispositifs de suspension en liaison avec des palans.

815187

Schaukelkette entsprechend DIN EN 1176 / A2-AISI 304

Swing chain in accordance with DIN EN 1176 / Chaîne de balançoire en accord DIN EN 1176

NEW



Artikel-Nr. Item-no.	ø	iL	B	GW	L	**BL kg	Box	*€/Stück *€/piece
8151872062000	6	18,5	20	M8	≈2000	1630	2	42,80
8151872062500	6	18,5	20	M8	≈2500	1630	2	51,00
8151872063000	6	18,5	20	M8	≈3000	1630	2	60,00

Schaukelketten geprüft nach DIN EN 1176

Die Schaukelketten entsprechen den höchsten Sicherheits- und Qualitätsstandards nach der Europäischen Norm EN 1176 für den Einsatz auf öffentlichen und gewerblichen Spielplätzen.

Swing chains tested according to DIN EN 1176

These swing chains fulfil the highest safety and quality requirements under European standard EN 1176 for use in public and commercial playgrounds.

Chaînes de balançoire testées selon la norme DIN EN 1176.

Les chaînes de balançoire sont conformes aux standards les plus élevés de sécurité et de qualité selon la norme européenne EN 1176 pour une utilisation sur les aires de jeux publiques et commerciales.

Rundstahlkette langglied, ähnlich DIN 763 / A2-AISI 304 / A4-AISI 316

Chain long-link, similar to DIN 763 / Chaîne maillon long similaire à DIN 763

8301

Artikel-Nr. A2 Item-no. A2	Artikel-Nr. A4 Item-no. A4	ø	iL	B	**BL kg	Bund m A2/A4 Bundle m A2/A4	*€/m A2	*€/m A4
83012015	83014015	1,5***	12	6	90	100	1,40	2,00
8301202	8301402	2,0***	22	8	120	100	1,20	2,00
8301203	8301403	3,0***	26	12	320	100	2,40	3,90
8301204	8301404	4,0	32	16	610	50	4,40	6,80
8301205	8301405	5,0	35	20	1000	50	6,90	10,00
8301206	8301406	6,0	42	24	1250	50	11,80	15,60
8301208	8301408	8,0	52	32	2500	50	21,90	28,00
8301210	8301410	10,0	65	40	4000	50	35,40	43,30
–	8301413	13,0	82	52	6300	50	–	84,80

*** Ähnlich DIN 5685C.

*** Similar to DIN 5685C.

*** Similaires à DIN 5685C.

Kette kalibriert und lehrenhaltig

Chain calibrated and true to gauge

Chaîne calibrée et conforme au gabarit

 Diese Ketten dürfen nicht als Lastaufnahmemittel, Anschlagmittel oder Tragmittel in Verbindung mit Hebezeugen verwendet werden!

Don't use these chains as load suspension devices or slinging devices in connection with hoists.

Ces chaînes ne doivent pas être utilisées comme dispositifs de levage, élingues ou comme dispositifs de suspension en liaison avec des palans.



5

Rundstahlkette kurzglied, ähnlich ISO 4565 / A4-AISI 316

Chain short-link, similar to ISO 4565 / Chaîne maillon court similaire à ISO 4565

8747

Artikel-Nr. Item-no.	ø	iL	B	**BL kg	Bund m Bundle m	*€/m
8747410	10	30	34	5000	50	60,00

Der Unterschied zur DIN 766 10mm ist hier die innere Gliedlänge 30mm.

The difference to DIN 766 10mm is the inner length of a chain length 30mm.

La différence à la DIN 766 10mm est la longueur du maillon intérieur de 30mm.

 Diese Ketten dürfen nicht als Lastaufnahmemittel, Anschlagmittel oder Tragmittel in Verbindung mit Hebezeugen verwendet werden!

Don't use these chains as load suspension devices or slinging devices in connection with hoists.

Ces chaînes ne doivent pas être utilisées comme dispositifs de levage, élingues ou comme dispositifs de suspension en liaison avec des palans.

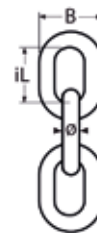

Ketten und Verbinder

Chains and connectors

Chaînes, maillons rapides et jonctions

8695

Knotenkette, ähnlich DIN 5686 / A4-AISI 316

Knotted chain, similar to DIN 5686 / Chaîne maillon noué similaire à DIN 5686

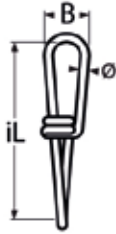

	Artikel-Nr. Item-no.	ø	iL	B	Bund m Bundle m	*€/m
NEW	86954010	1,0	14,0	4,5	30	1,30
NEW	86954012	1,2	17,0	5,5	30	1,40
NEW	86954014	1,4	20,0	6,5	30	1,60
	86954016	1,6	23,0	7,0	30	2,00
	86954018	1,8	26,5	8,0	30	2,30
	86954020	2,0	28,0	9,0	30	3,20
	86954022	2,2	31,0	10,0	30	3,40
	86954025	2,5	35,0	11,0	30	4,50
	86954028	2,8	39,0	12,5	30	5,50
NEW	86954031	3,1	40,0	14,0	30	5,70
NEW	86954034	3,4	44,0	15,0	30	6,40
NEW	86954038	3,8	46,0	17,0	30	7,90
NEW	86954042	4,2	50,0	19,0	30	11,70
NEW	86954046	4,6	55,0	21,0	30	13,40
NEW	86954050	5,0	66,0	23,0	30	15,60



Diese Ketten dürfen nicht als Lastaufnahmemittel, Anschlagmittel oder Tragmittel in Verbindung mit Hebezeugen verwendet werden!

Don't use our chains as load suspension devices or slinging devices in connection with hoists.

Nos chaînes ne doivent pas être utilisées comme dispositifs de levage, élingues ou comme dispositifs de suspension en liaison avec des palans.

814972

Panzerkette / A2-AISI 304

Curb chain / Chaîne torse



	Artikel-Nr. Item-no.	ø	iL	B	**BL kg	Bund m Bundle m	*€/m
	8149722020	2,0	6,5	7,6	130	10	17,50
	8149722025	2,5	8,6	8,8	210	10	18,30
	8149722030	3,0	11,8	11,3	300	5	21,10
	8149722040	4,0	16,5	14,4	470	5	30,40



Diese Ketten dürfen nicht als Lastaufnahmemittel, Anschlagmittel oder Tragmittel in Verbindung mit Hebezeugen verwendet werden!

Don't use these chains as load suspension devices or slinging devices in connection with hoists.

Ces chaînes ne doivent pas être utilisées comme dispositifs de levage, élingues ou comme dispositifs de suspension en liaison avec des palans.

Ketten und Verbinder

Chains and connectors

Chaînes, maillons rapides et jonctions

5

Panzerkette schwarz brüniert / A2-AISI 304

Curb chain black burnished / Chaîne torse noir bruni

814973

Artikel-Nr. Item-no.	ø	iL	B	**BL kg	Bund m Bundle m	*€/m
8149732020	2,0	6,5	7,6	130	10	19,10
8149732025	2,5	8,6	8,8	210	10	22,00
8149732030	3,0	11,8	11,3	300	5	25,80
8149732040	4,0	16,5	14,4	470	5	38,70

 Diese Ketten dürfen nicht als Lastaufnahmemittel, Anschlagmittel oder Tragmittel in Verbindung mit Hebezeugen verwendet werden!

Don't use these chains as load suspension devices or slinging devices in connection with hoists.

Ces chaînes ne doivent pas être utilisées comme dispositifs de levage, élingues ou comme dispositifs de suspension en liaison avec des palans.



GleisteinRopes
The Perfect Line

Kettenkralle mit gespleißtem Seil / A4-AISI 316 / PP

Chain claw with spliced rope / Griffe pour chaîne avec corde épissée

814780

Artikel-Nr. Item-no.	Für Kette-Ø For chain-Ø	L	L1	iD	Seil-Ø Rope-Ø	Box	*€/Stück *€/piece
814780406	6	3000	160	16	14	1	72,00
814780408	8	3000	205	16	14	1	88,00
814780410	10	3000	215	16	14	1	96,00
814780413	13	3000	225	27	18	1	112,00

Seil von GleisteinRopes

Rope by GleisteinRopes

Corde par GleisteinRopes

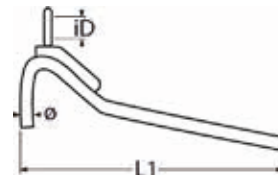

Kettenmarkierung für Ankerketten / PA

Markers for anchor chain / Marquage de chaîne pour chaîne d'ancre

8821

Artikel-Nr. Item-no.	Für Kette-Ø For chain-Ø	Box	*€/Stück *€/piece
8821306	6	50	0,99
8821308	8	50	1,05
8821310	10	50	1,10
8821313	13	50	2,20

Seewasserbeständig und schlagfest - grün-blau-pink-weiß-gelb, je 10 Stück pro Farbe in einer Box.

Seawater resistant and shockproof - green-blue-pink-white-yellow, 10 pcs of each colour per box.

Résistant à l'eau de mer et résistant aux chocs. 10 pcs de chaque couleur, vert, bleu, rose, blanc, blanc, jaune dans une boîte.

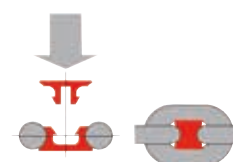

Ketten und Verbinder

Chains and connectors
Chaînes, maillons rapides et jonctions

8286

C-Ring / A4-AISI 316
C-ring / Maillon ouvert

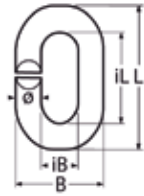

Artikel-Nr. Item-no.	ø	L	iL	B	iB	Box	*€/Stück *€/piece
8286405	5	30	20	17,5	8	10	1,40
8286406	6	36	24	21,0	9	10	1,50
8286408	8	48	32	28,0	12	10	2,10
8286410	10	60	40	35,0	15	10	3,40
8286413	13	78	52	46,0	20	5	7,60
8286416	16	96	64	56,0	24	5	16,20

8363

Kettennotglied zum Einnieten / A4-AISI 316
Chain emergency link / Maillon de chaîne à river

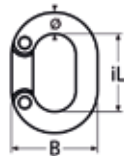

Artikel-Nr. Item-no.	Für Kette-Ø For chain-Ø	ø	iL	B	**BL kg	Box	*€/Stück *€/piece
8363405	5	5	17,5	19	500	10	3,50
8363406	6	6	21,0	24	780	10	3,60
8363408	8	8	24,0	28	1400	10	4,20
8363410	10	10	29,0	34	2000	10	4,50

8414

Lee-Anker, M-Anker, hochglanzpoliert / A4-AISI 316
Lee anchor, M-anchor, mirror polished / Ancre FHD poli miroir

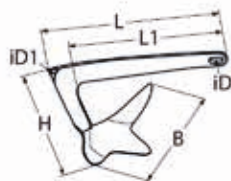

Artikel-Nr. Item-no.	kg	L	L1	B	H	iD	iD1	Box	*€/Stück *€/piece
84144010	1,0	260	210	170	100	10	6	1	90,00
84144020	2,0	345	280	230	135	6	5	1	156,00
84144050	5,0	470	375	300	180	12	8	1	302,00
84144075	7,5	540	430	360	220	13	10	1	492,00
84144100	10,0	580	460	390	230	13	8	1	615,00
84144150	15,0	665	530	440	260	12	10	1	1150,00
84144200	20,0	640	510	500	260	13	10	1	1445,00

Anker für Bootslänge	2m	5m	8m	11m	14m	17m	20m
1kg	■						
2kg	■	■					
5kg		■	■				
7,5kg			■	■			
10kg				■	■		
15kg					■	■	
20kg						■	■

Unsere Auswahlhilfe dient nur zur Orientierung. Sollten Sie Zweifel haben, wählen Sie bitte ein Ankergewicht höher.

Beachten Sie für Ihre Auswahl auch den vorherrschenden Ankergrund, anfallende Windgeschwindigkeiten, Strömungen, Seegang, etc.

Our selection guide is only a recommendation. If you're not sure, please select an anchor weight higher.

For your selection, please note the ground, wind speed, water flow, swell, etc.

Notre guide de sélection est à titre d'orientation seulement. En cas de doute, veuillez choisir un poids d'ancre plus élevé.

Pour votre sélection, tenez également compte du mouillage, de la vitesse du vent, des courants, de l'état de la mer, etc.

Ketten und Verbinder

Chains and connectors

Chaînes, maillons rapides et jonctions

5

Klappdraggen, hochglanzpoliert / A4-AISI 316

Draggen anchor, mirror polished / Ancre grappin repliable poli miroir

8376

Artikel-Nr. Item-no.	kg	L	L1	B	iD	Box	*€/Stück *€/piece
8376415	1,5	300	225	260	12	1	122,00
8376425	2,5	335	270	290	13	1	195,00
8376440	4,0	430	320	375	16	1	340,00

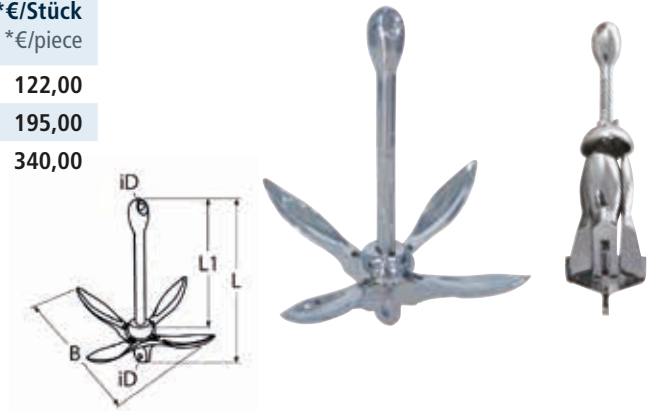

Wurfanker / A4-AISI 316

Grappling anchor / Ancre grappin

8530

Artikel-Nr. Item-no.	kg	ø	L	iD	Box	*€/Stück *€/piece
85304200	0,5	6	200	33	1	22,00
85304240	1,0	8	240	43	1	43,00
85304315	1,9	10	315	50	1	90,00
85304375	3,0	12	375	61	1	138,00

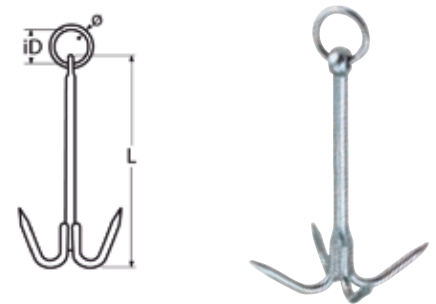

Bodenanker / A4-AISI 316

Ground anchor / Piquet d'amarrage

8547

Artikel-Nr. Item-no.	L	iD	ø	ø1	Box	*€/Stück *€/piece
85474420	420	27	8	4	1	25,00

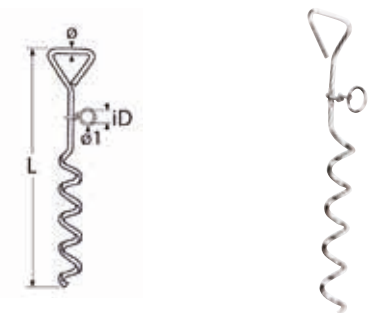

Bodenanker, schwere Ausführung / A2-AISI 304

Ground anchor, heavy duty / Piquet d'amarrage lourd

814905

Artikel-Nr. Item-no.	L	B	iD	ø	ø1	Box	*€/Stück *€/piece
8149052340	360	225	30	12	10	1	78,00

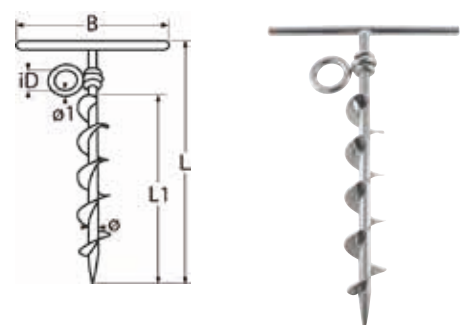

5

Ketten und Verbinder

Chains and connectors

Chaînes, maillons rapides et jonctions

814843

Pilzanker mit Schäkel / Stahl / PVC

Mushroom anchor with shackle / Steel / PVC / Ancre champignon avec manille droite / Acier / PVC



Artikel-Nr. Item-no.	kg	L	D	Box	*€/Stück *€/piece
8148431036	3,6	180	200	1	58,00
8148431045	4,5	200	210	1	67,00
8148431012	12,0	280	290	1	189,00

Inkl. Schäkel 10mm
Incl. shackle 10mm
Incl. manille 10mm.

8460

Kettenklüse 90° / A4-AISI 316

Deck chain pipe 90° / Ecubier pour chaîne 90°

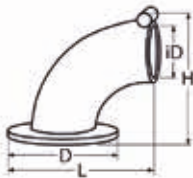

Artikel-Nr. Item-no.	Für Kette-Ø For chain-Ø	L	H	D	iD	Box	*€/Stück *€/piece
8460406 08	6-8	105	110	95	60	1	61,00
8460410 13	10-13	130	110	95	60	1	70,00

8308

Tau- und Kettendurchlass / A4-AISI 316

Chain and rope hawse pipe / Ecubier pour chaîne et corde

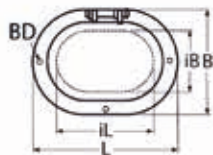

Artikel-Nr. Item-no.	L	B	iL	iB	BD	Box	*€/Stück *€/piece
83084140 100	140	100	95	60	5,2	1	86,00

814302

Ankerkettengreifer / A4-AISI 316

Mooring device, chain grab / Main de fer



Artikel-Nr. Item-no.	Für Kette-Ø For chain-Ø	Box	*€/Stück *€/piece
814302406 08	6-8	1	27,50
814302410 12	10-13	1	84,00

Ketten und Verbinder

Chains and connectors

Chaînes, maillons rapides et jonctions

5

Kettenstopper / A4-AISI 316

Chain stopper / Bloqueur de chaîne

8506

Artikel-Nr. Item-no.	Für Kette-Ø For chain-Ø	L	B	H	BD	Box	*€/Stück *€/piece
8506406/08	6-8	60	54	48	8,2	1	40,00
8506408/10	8-10	80	70	60	8,2	1	69,00

Wir empfehlen Senkschrauben DIN 965 M8.

We recommend countersunk screws DIN 965 M8.

Nous recommandons des vis à tête fraisée DIN 965 M8.

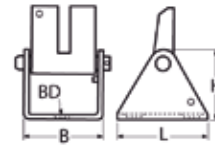

Kettenstopper mit Pin / A4-AISI 316

Chain stopper with pin / Bouchon de chaîne avec goupille

815196

Artikel-Nr. Item-no.	Für Kette-Ø For chain-Ø	L	B	H	Box	*€/Stück *€/piece
815196408 10	8-10	62	62	86	1	135,00
815196410 13	10-13	86	86	113	1	203,00

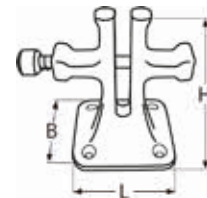

Kettenstopper / A4-AISI 316

Chain stopper / Bouchon de chaîne

815197

Artikel-Nr. Item-no.	Für Kette-Ø For chain-Ø	L	B	H	Box	*€/Stück *€/piece
815197408 10	8-10	62	62	86	1	116,00

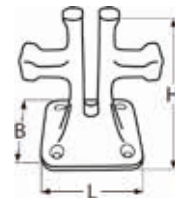

Ankerkettenwirbel / A4-AISI 316

Anchor chain swivel / Jonction chaîne-ancre

8352

Artikel-Nr. Item-no.	Für Kette-Ø For chain-Ø	L	iB	iB1	ø	ø1	**BL kg	AL kg WLL kg	Box	*€/Stück *€/piece
8352406 08	6-8	84	16	9	10	7,5	3290	850	1	66,00
8352410 12	10-13	96	22	13	12	10	4900	1350	1	105,00
8352414 16	14-16	150	26	16,5	16	12	6290	1700	1	330,00

NEW



Ketten und Verbinder

Chains and connectors

Chaînes, maillons rapides et jonctions

8359

Ankerkettenverbinder / A4-AISI 316
Anchor chain connector / Jonction chaîne-ancre



NEW



Artikel-Nr. Item-no.	Für Kette Ø For chain Ø	ø	ø1	L	iB	iB1	**BL kg	AL kg WLL kg	Box	*€/Stück *€/piece
8359406 08	6-8	10	7,5	79	15	10	3290	850	1	53,00
8359410 12	10-13	12	10,0	91	22	13	4900	1350	1	98,00

8608

Ankerkettenwirbel mit Gelenk / A4-AISI 316
Anchor chain swivel with joint / Jonction articulée double chaîne-ancre



Artikel-Nr. Item-no.	Für Kette-Ø For chain-Ø	L	iB	iB1	ø	ø1	**BL kg	AL kg WLL kg	Box	*€/Stück *€/piece
8608406/08	6-8	134	16	9	10	7,5	3290	850	1	71,00
8608410/12	10-13	154	22	13	12	10	4900	1350	1	124,00

815140

Anker-Tau-Verbinder mit Wirbel / A4-AISI 316
Anchor rope connector / Jonction cordage-ancre



NEW



Artikel-Nr. Item-no.	Für Kette Ø For chain Ø	L	iL	iB	ø	**BL kg	AL kg WLL kg	Box	*€/Stück *€/piece
815140416	max. 16	100	37	18	10	2100	850	1	76,50

814652

Ankerkettenwirbel für Bugrolle / A4-AISI 316
Anchor chain swivel for bow roller / Jonction chaîne-ancre coudée



Artikel-Nr. Item-no.	Für Kette-Ø For chain-Ø	L	iB	iD	ø	**BL kg	Box	*€/Stück *€/piece
814652406 08	6-8	220	10,0	11,0	7,5	2850	1	126,00
814652408 10	8-10	290	13,5	14,5	12,0	5680	1	308,00

Ketten und Verbinder

Chains and connectors

Chaînes, maillons rapides et jonctions

5



Gelenk für Ankerkettenwirbel / A4-AISI 316

Joint for anchor chain swivel / Adaptateur jonction chaîne-ancre

814663

Artikel-Nr. Item-no.	ø	L	iB	iD	S	**BL kg	AL kg WLL kg	Box	*€/Stück *€/piece
814663467	10	67	16	7,6	8	3290	850	1	38,10

Für Ankerkettenwirbel Artikel-Nr.: 8352406 08.
For anchor chain swivel article-no. 8352406 08.
Pour Jonction chaîne pour ancre article no. 8352406 08.

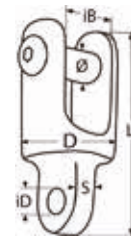

Kettenfanghaken / A4-AISI 316

Clevis grab hook / Croc de palan pour chaîne

8388

Artikel-Nr. Item-no.	Für Kette-Ø For chain-Ø	ø	L1	iB	C	**BL kg	Box	*€/Stück *€/piece
8388406	6	9	46	11	9	2300	5	8,50
8388408	8	11	54	13	11	3650	5	16,80
8388410	10	13	62	15	12	4640	5	22,20



Bugrolle lang / A4-AISI 316

Long bow roller / Davier long

8560

Artikel-Nr. Item-no.	L	L1	B	Box	*€/Stück *€/piece
85604500	500	410	70	1	306,30

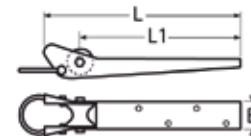

Ankerrolle mit Querbolzen / A2-AISI 304

Bow roller with pin / Davier avec tige

8595

Artikel-Nr. Item-no.	L	L1	B	H	ø	BD	Box	*€/Stück *€/piece
85952200	200	97	60	80	10	7	1	57,50
85952250	250	147	60	80	10	7	1	67,00

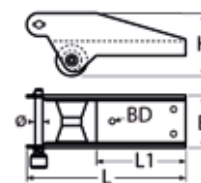

Ketten und Verbinder

Chains and connectors

Chaînes, maillons rapides et jonctions

8566

Bugrolle kurz / A2-AISI 304

Short bow roller / Davier court

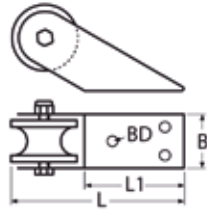

Artikel-Nr. Item-no.	L	L1	B	BD	Box	*€/Stück *€/piece
8566250	160	110	50	10	1	38,70

814386

Heckankerausleger / A4-AISI 316

Stern anchor mounting / Davier d'ancre de poupe

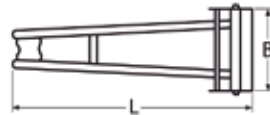
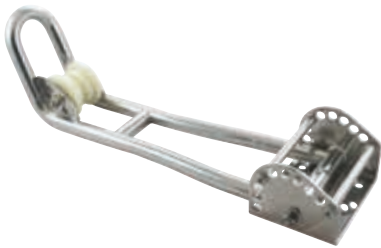

Artikel-Nr. Item-no.	L	B	Box	*€/Stück *€/piece
8143864535	535	150	1	240,00

8551

Ankergurtbandrolle / A4-AISI 316

Flat line spool / Enrouleur de sangles

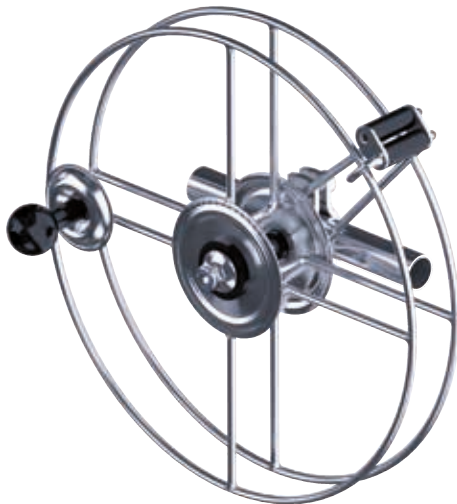

Artikel-Nr. Item-no.	D	Für Rohr-Ø For tube-Ø	iB	Gurtbreite Strap width	Gurtlänge Strap length	Box	*€/Stück *€/piece
85514340	340	22 - 25	37	35	30m	1	337,00
85514430	430	22 - 25	37	35	50m	1	500,00
8551330GURT	Ersatzgurt 30m / Spare webbing 30m / Sangle de rechange 30m					1	108,00
8551350GURT	Ersatzgurt 50m / Spare webbing 50m / Sangle de rechange 50m					1	159,00

Gurtband aus Polyester BL 3200kg
Webbing made of polyester BL 3200kg
Sangle en polyester CR 3200kg

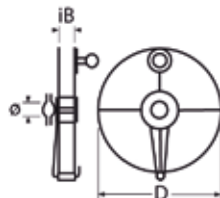

Technische Informationen

Technical information
Informations techniques



Ketten und Verbinder

Chains and connectors

Chaînes, maillons rapides et jonctions

5



Lasthaken mit Öse, Duplex / D6-AISI 318 LN

Duplex sling hook / Crochet à œil en Duplex

815111

NEW

Artikel-Nr. Item-no.	Für Kette Ø For chain Ø	ø	L	B	iD	C	AL kg WLL kg	**BL kg	Box	*€/Stück *€/piece
815111446206	5-6	8	119	72	21	23	900	3600	1	96,00
815111446208	7-8	13	160	103	27	32	1600	6400	1	128,00
815111446210	10	15	188	120	37	39	2500	10000	1	208,00
815111446213	13	18	246	155	48	51	4250	17000	1	334,00
815111446216	16	24	288	183	55	66	6300	25200	1	488,00

Duplex D6-AISI 318LN = 1.4462 (PREN 36,2) Güteklasse 6, 4-fache Sicherheit, Federriegel besteht aus A4

Grade 60, Safety coefficient 4, Spring latch is made of A4

Degré 60, Coefficient de sécurité de 4, Loquet à ressort en A4



Lasthaken mit Gabel, Duplex / D6-AISI 318 LN

Duplex clevis sling hook / Crochet à chape en Duplex

815112

NEW

Artikel-Nr. Item-no.	Für Kette Ø For chain Ø	ø	L	B	iL	iL1	iB	C	AL kg WLL kg	**BL kg	Box	*€/Stück *€/piece
815112446206	6	8	115	72	71,5	8,5	7,2	23	900	3600	1	135,00
815112446208	8	10	156	103	99,4	11,0	9,5	32	1600	6400	1	173,00
815112446210	10	13	177	120	105,7	15,0	12,0	39	2500	10000	1	262,00

Duplex D6-AISI 318LN = 1.4462 (PREN 36,2) Güteklasse 6, 4-fache Sicherheit, Federriegel besteht aus A4

Grade 60, Safety coefficient 4, Spring latch is made of A4

Degré 60, Coefficient de sécurité de 4, Loquet à ressort en A4

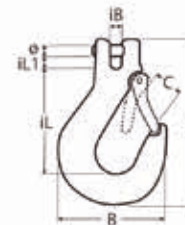

Rundschäkel mit Splint, Duplex / D6-AISI 318 LN

Duplex D-shackle with split pin / Manille avec goupille en Duplex

815113

NEW

Artikel-Nr. Item-no.	GW	ø	ø1	iL	iB	AL kg WLL kg	**BL kg	Box	*€/Stück *€/piece
815113446209	M10	9	8	33	18	500	2000	1	14,60
815113446213	M14	13	12	40	25	1250	5000	1	26,80
815113446217	M18	17	16	60	32	2000	8000	1	52,00
815113446221	M22	21	19	78	41	3200	12800	1	99,00
815113446229	M30	29	25	109	56	5000	20000	1	216,00
815113446238	M39	38	34	152	76	13000	52000	1	503,00

Duplex D6-AISI 318LN = 1.4462 (PREN 36,2) Güteklasse 6, 4-fache Sicherheit, Splint besteht aus A4

Grade 60, Safety coefficient 4, Split pin is made of A4

Degré 60, Coefficient de sécurité de 4, Goupille en A4

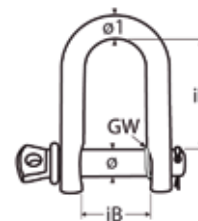

815114

Verbindungsglied, Duplex / D6-AISI 318 LN
 Duplex connecting link / Maillon de jonction en Duplex

NEW

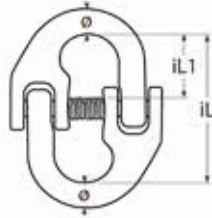

Artikel-Nr. Item-no.	Für Kette Ø For chain Ø	ø	iL	iL1	AL kg WLL kg	**BL kg	Box	*€/Stück *€/piece
815114446206	6	8,0	45,0	18,0	900	3600	1	65,00
815114446208	8	11,5	62,0	25,5	1600	6400	1	78,00
815114446210	10	12,6	72,0	30,0	2500	10000	1	102,00
815114446213	13	19,0	87,5	36,0	4250	17000	1	146,00
815114446216	16	20,6	105,0	40,5	6300	25200	1	239,00

Duplex D6-AISI 318LN = 1.4462 (PREN 36,2) Güteklasse 6, 4-fache Sicherheit

Grade 60, Safety coefficient 4

Degré 60, Coefficient de sécurité de 4

815115

Ringschraube, drehbar, Duplex / D6-AISI 318 LN
 Duplex rotatable lifting eye bolt / Anneau de levage émerillon en Duplex

NEW

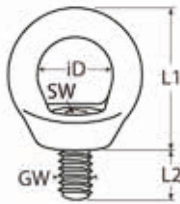

Artikel-Nr. Item-no.	GW	iD	L1	L2	Antrieb Drive	AL kg WLL kg	**BL kg	Box	*€/Stück *€/piece
815115446212	M12	30	55,5	18	SW8	500	2000	1	110,00
815115446216	M16	35	64,0	24	SW10	1000	4000	1	144,00
815115446220	M20	40	74,0	30	SW12	2000	8000	1	170,00
815115446224	M24	49	89,5	36	SW12	2500	10000	1	236,00

Duplex D6-AISI 318LN = 1.4462 (PREN 36,2) Güteklasse 6, 4-fache Sicherheit

Grade 60, Safety coefficient 4

Degré 60, Coefficient de sécurité de 4

815116

Verkürzungsklaue, Duplex / D6-AISI 318 LN
 Duplex shortening clutch / Griffe de racc ourcissement en Duplex

NEW

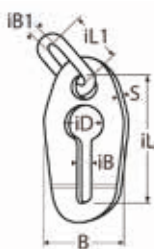

Artikel-Nr. Item-no.	Für Kette Ø For chain Ø	ø	L1	B	B1	iD	iL	S	AL kg WLL kg	**BL kg	Box	*€/Stück *€/piece
815116446206	5-6	8	35	55	16	16	81	8,5	900	3600	1	116,00
815116446208	7-8	10	44	71	20	22	110	10,5	1600	6400	1	148,00
815116446210	10	13	54	90	25	26	135	13,0	2500	10000	1	264,00
815116446213	13	16	70	112	34	32	170	16,5	4250	17000	1	342,00
815116446216	16	20	85	135	40	38	202	20,0	6300	25200	1	600,00

Duplex D6-AISI 318LN = 1.4462 (PREN 36,2) Güteklasse 6, 4-fache Sicherheit

Grade 60, Safety coefficient 4

Degré 60, Coefficient de sécurité de 4

Ketten und Verbinder

Chains and connectors

Chaînes, maillons rapides et jonctions

5



Oval-Aufhänger 1-2-Strang, Duplex / D6-AISI 318 LN

Duplex oblong masterlink 1-2 legs / Maille de tête ovale 1-2 brins en Duplex

815117

NEW

Artikel-Nr. Item-no.	Für Kette Ø For chain Ø	ø	iL	iB	AL kg WLL kg	**BL kg	Box	*€/Stück *€/piece
815117446206	6 (7)	13	110	60	1600	6400	1	50,00
815117446208	8 (10)	16	110	60	2600	10400	1	62,00
815117446210	10 (13)	18	135	75	4250	17000	1	97,00
815117446213	13 (16)	22	160	90	6300	25200	1	150,00
815117446216	16 (18)	26	180	100	8900	35600	1	225,00



Duplex D6-AISI 318LN = 1.4462 (PREN 36,2) Güteklasse 6, 4-fache Sicherheit, Werte in Spalte „Für Kette-Ø“ in Klammern sind für 1-Strang Aufhängung.

Grade 60, Safety coefficient 4, Values in the column „For chain Ø“ in brackets are for 1-strand suspension.

Degré 60, Coefficient de sécurité de 4, Les valeurs dans la colonne „pour chaîne Ø“ entre parenthèses sont pour une suspension à 1 brin.



Oval-Aufhänger 3-4-Strang, Duplex / D6-AISI 318 LN

Duplex oblong masterlink 3-4 legs / Maille de tête ovale 3-4 brins en Duplex

815118

NEW

Artikel-Nr. Item-no.	Für Kette Ø For chain Ø	ø	ø1	iL	iL1	iB	iB1	AL kg WLL kg	**BL kg	Box	*€/Stück *€/piece
815118446206	6	13	10	110	44	60	20	1890	7560	1	125,00
815118446208	8	18	16	135	70	75	34	3350	13400	1	180,00
815118446210	10	22	18	160	85	90	40	5250	21000	1	285,00
815118446213	13	26	22	180	115	100	50	8900	35600	1	420,00
815118446216	16	32	26	200	140	110	65	13200	52800	1	695,00

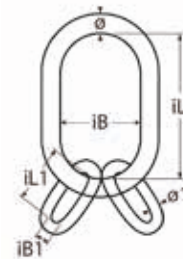

Duplex D6-AISI 318LN = 1.4462 (PREN 36,2) Güteklasse 6, 4-fache Sicherheit

Grade 60, Safety coefficient 4

Degré 60, Coefficient de sécurité de 4



Prüfplakette und Ring, Duplex / D6-AISI 318 LN

Duplex identification tag and ring / Plaque de identification et anneau en Duplex

815119

NEW

Artikel-Nr. Item-no.	Ausführung Type	Box	*€/Stück *€/piece
81511944620	Ring Ring Anneau	5	11,00
81511944621	Plakette 1-Strang Tag for 1 leg Plaque pour 1 brin	5	11,00
81511944624	Plakette 2-4-Strang Tag for 2-4 leg Plaque pour 2-4 brin	5	11,00



Duplex D6-AISI 318LN = 1.4462 (PREN 36,2)



Scharniere, Griffe, Haken und Ringe

Hinges, handles, hooks and rings

Charnières, poignées, crochets et anneaux

Kapitel 6

Chapter 6



Scharniere

Hinges
Charnières



Haken und Halter

Hooks and holder
Crochets et supports



Überfallscharniere

Hasps
Fermetures



Ringe

Rings
Anneaux



Griffe und Handlauf

Handles and rails
Poignées et embouts



Yachtzubehör + Ausrüstung

Yachting accessories +
equipment
Accessories pour yachts
+ equipment

6

Scharniere, Griffe, Haken und Ringe

Hinges, handles, hooks and rings

Charnières, poignées, crochets et anneaux

8321

Stangenscharnier / A2-AISI 304

Continuous hinge / Charnière piano

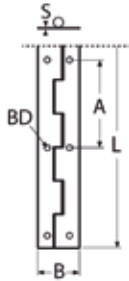

Artikel-Nr. Item-no.	L	B	A	S	BD	Ausführung Type	*€/m *€/m
8321207 16	3500	16	74	0,7	2,4	mit Bohrung / drilled	24,80
8321207 16 1000	1000	16	74	0,7	2,4	mit Bohrung / drilled	25,80
8321207 18	3500	18	74	0,7	3,2	mit Bohrung / drilled	25,30
8321207 18UG	3500	18	–	0,7	–	ohne Bohrung / undrilled	24,30
8321207 20	3500	20	74	0,7	3,2	mit Bohrung / drilled	26,30
8321207 20 1000	1000	20	74	0,7	3,2	mit Bohrung / drilled	28,00
8321207 20UG	3500	20	–	0,7	–	ohne Bohrung / undrilled	25,30
8321207 25	3500	25	74	0,7	3,6	mit Bohrung / drilled	26,80
8321207 25 1000	1000	25	74	0,7	3,6	mit Bohrung / drilled	27,80
8321207 25UG	3500	25	–	0,7	–	ohne Bohrung / undrilled	24,30
8321207 32	3500	32	74	0,7	4,2	mit Bohrung / drilled	27,50
8321207 32 1000	1000	32	74	0,7	4,2	mit Bohrung / drilled	28,50
8321207 32UG	3500	32	–	0,7	–	ohne Bohrung / undrilled	26,50
8321207 40	3500	40	74	0,7	4,2	mit Bohrung / drilled	29,00
8321207 40 1000	1000	40	74	0,7	4,2	mit Bohrung / drilled	30,00
8321207 40UG	3500	40	–	0,7	–	ohne Bohrung / undrilled	28,50
8321215 32	2000	32	70	1,5	4,2	mit Bohrung / drilled	36,00
8321215 32 1000	1000	32	70	1,5	4,2	mit Bohrung / drilled	40,00
8321215 32UG	2000	32	–	1,5	–	ohne Bohrung / undrilled	35,00
8321215 40	2000	40	70	1,5	4,2	mit Bohrung / drilled	42,00
8321215 40 1000	1000	40	70	1,5	4,2	mit Bohrung / drilled	44,00
8321215 40UG	2000	40	–	1,5	–	ohne Bohrung / undrilled	38,00

8233

Scharnier / A4-AISI 316

Hinge / Charnière

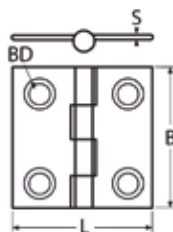

Artikel-Nr. Item-no.	L	B	S	BD	Box	*€/Stück *€/piece
8233438 38	38	38	4	4,2	4	7,20
8233450 50	50	50	4	5,3	4	8,00

814940

Scharnier / A4-AISI 316

Hinge / Charnière

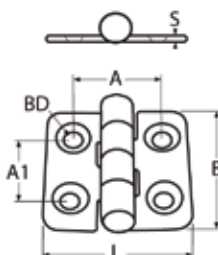

Artikel-Nr. Item-no.	L	B	A	A1	S	BD	Box	*€/Stück *€/piece
814940438 38	38	38	25	20	2	5,5	10	4,30

Scharniere, Griffe, Haken und Ringe

Hinges, handles, hooks and rings
Charnières, poignées, crochets et anneaux

6



Scharnier / A4-AISI 316
Hinge / Charnière

814920

Artikel-Nr. Item-no.	L	B	A	A1	S	BD	Box	*€/Stück *€/piece
8149204525 495	52,5	49,5	38	33,5	3,5	4,5	2	18,40

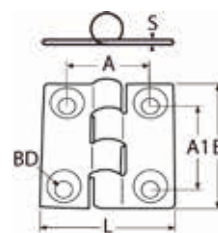

Scharnier / A4-AISI 316
Hinge / Charnière

8234

Artikel-Nr. Item-no.	L	L1	B	S	BD	Box	*€/Stück *€/piece
8234456 38	57	20	38	4	5,3	4	9,00
8234476 38	76	20	38	4	5,3	4	9,80

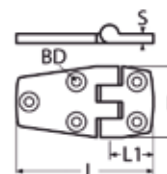

Scharnier / A4-AISI 316
Hinge / Charnière

8237

Artikel-Nr. Item-no.	L	B	H	S	BD	Box	*€/Stück *€/piece
8237456 38	52	38	20	4	4,5	4	15,00
8237470 38	68	38	20	4	4,5	4	19,00

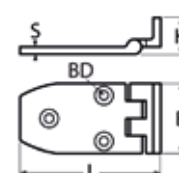

Scharnier / A4-AISI 316
Hinge / Charnière

8231

Artikel-Nr. Item-no.	L	B	S	BD	Box	*€/Stück *€/piece
82314076	76	38	4	5,3	4	10,70
82314100	100	38	4	5,3	4	11,00

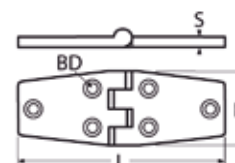

6

Scharniere, Griffe, Haken und Ringe

Hinges, handles, hooks and rings

Charnières, poignées, crochets et anneaux

8235

Scharnier / A4-AISI 316
Hinge / Charnière

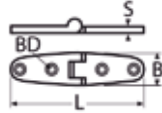

Artikel-Nr. Item-no.	L	B	S	BD	Box	*€/Stück *€/piece
82354100 25	100	25	4	5,3	4	8,00

8236

Scharnier / A4-AISI 316
Hinge / Charnière

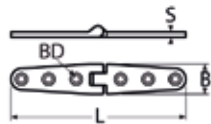

Artikel-Nr. Item-no.	L	B	S	BD	Box	*€/Stück *€/piece
82364160 27	160	27	4	4,9	4	14,30

814926

Scharnier / A4-AISI 316
Hinge / Charnière



Artikel-Nr. Item-no.	L	A	B	S	BD	Box	*€/Stück *€/piece
8149264170 85	170	38,7	18,5	4,7	6,5	2	16,80

8858

T-Scharnier / A4-AISI 316
T-hinge / Charnière en T

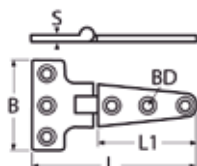

Artikel-Nr. Item-no.	L	L1	B	S	BD	Box	*€/Stück *€/piece
88584100 54	100	60	54	4	5,3	2	8,70
88584152 75	152	110	75	4	5,3	2	13,30
88584197 98	195	140	98	5	5,3	2	28,60

Scharniere, Griffe, Haken und Ringe

Hinges, handles, hooks and rings
Charnières, poignées, crochets et anneaux

6



Scharnier / A4-AISI 316
Hinge / Charnière

814163

Artikel-Nr. Item-no.	L	B	S	A	A1	BD	Box	*€/Stück *€/piece
814163475 70	70	75	3	46	38,5	6	2	40,50

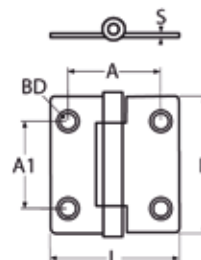

Scharnier / A4-AISI 316
Hinge / Charnière

814164

Artikel-Nr. Item-no.	L	B	S	BD	Box	*€/Stück *€/piece
8141644152 71	71	152	3,5	8,2	2	90,30

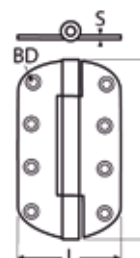

Scharnier / A4-AISI 316
Hinge / Charnière

814162

Artikel-Nr. Item-no.	L	L1	B	H	S	BD	Box	*€/Stück *€/piece
8141624152 76	76	22	152	24	3	6	2	66,40

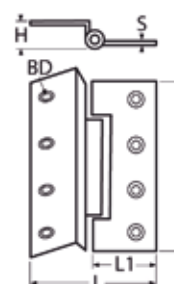

Scharnier / A4-AISI 316
Hinge / Charnière

814165

Artikel-Nr. Item-no.	L	L1	B	H	S	BD	Box	*€/Stück *€/piece
8141654100 102	89	36	102	33	3	5,5	2	92,00

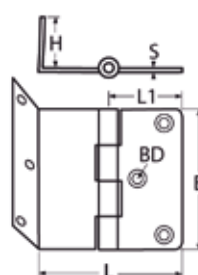

6

Scharniere, Griffe, Haken und Ringe

Hinges, handles, hooks and rings

Charnières, poignées, crochets et anneaux

8514

Scharnier, schwere Ausführung / A2-AISI 304

Hinge, heavy duty / Charnière lourde

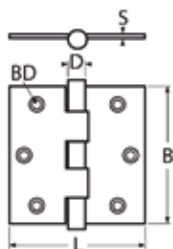

Artikel-Nr. Item-no.	L	B	D	S	BD	Box	*€/Stück *€/piece
8514275 75	75	75	10	2	6,7	2	16,10

8513

Scharnier, schwere Ausführung / A2-AISI 304

Hinge, heavy duty / Charnière lourde

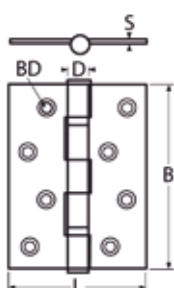

Artikel-Nr. Item-no.	L	B	D	S	BD	Box	*€/Stück *€/piece
85132100 75	75	100	11	2,5	6,4	2	18,90

814045

Scharnier, schwere Ausführung / A4-AISI 316

Hinge, heavy duty / Charnière lourde

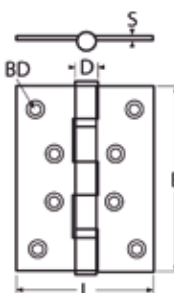

Artikel-Nr. Item-no.	L	B	D	S	BD	Box	*€/Stück *€/piece
8140454100 96	96	100	16	3	5,4	2	47,10

814159

Scharnier / A4-AISI 316

Hinge / Charnière

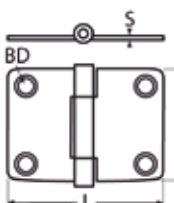
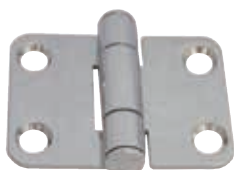

Artikel-Nr. Item-no.	L	B	S	BD	Box	*€/Stück *€/piece
814159449 37	49	37	2	5,5	4	12,30

Scharniere, Griffe, Haken und Ringe

Hinges, handles, hooks and rings

Charnières, poignées, crochets et anneaux

6

NEW

Scharnier / A4-AISI 316
Hinge / Charnière

815184

Artikel-Nr. Item-no.	L	B	A	S	BD	Box	*€/Stück *€/piece
815184490 60	90	60	40	3	6,5	2	9,00

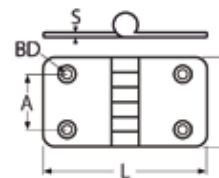

NEW

Kunststoff-Scharnier, quadratisch / A4-AISI 316 / PA
Plastic hinge, square / Charnière en plastique, carrée

815079

Artikel-Nr. Item-no.	L	B	H	A	S	BD	Box	*€/Stück *€/piece
815079330 30	30	30	7,0	18	3,0	3,2	10	3,20
815079340 40	40	40	10,2	25	5,2	5,3	6	5,20
815079350 50	50	50	11,9	30	5,9	6,4	2	6,80
815079360 60	60	60	13,5	36	6,5	6,4	2	9,20

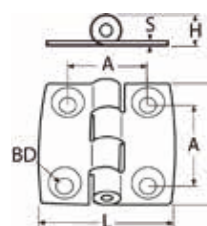

Die Scharniere bestehen aus Polyamid mit 30% Glasfaseranteil. Die Stifte bestehen aus Edelstahl A4 AISI-316.

The hinges are made of polyamide with 30% of glass fibre. The pins are made of stainless steel A4 AISI-316.

Les charnières sont en polyamide fibre de verre 30%, les broches sont en inox A4 AISI-316.

NEW

Kunststoff-Scharnier, symmetrisch / A4-AISI 316 / PA
Plastic hinge, symmetrical / Charnière en plastique, symétrique

815080

Artikel-Nr. Item-no.	L	B	H	A	A1	A2	S	BD	Box	*€/Stück *€/piece
815080340 080	80	40	10,2	19	13,5	25	5,2	5,3	2	6,90
815080340 120	120	40	10,2	38	14,5	25	5,2	5,3	2	8,60
815080350 100	100	50	11,9	24	16,0	30	5,9	6,4	2	8,50
815080360 120	120	60	13,5	30	18,0	36	6,5	6,4	2	13,50

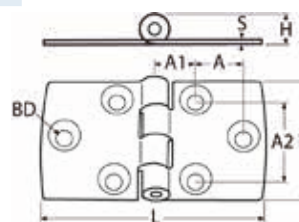

Die Scharniere bestehen aus Polyamid mit 30% Glasfaseranteil. Die Stifte bestehen aus Edelstahl A4 AISI-316.

The hinges are made of polyamide with 30% of glass fibre. The pins are made of stainless steel A4 AISI-316.

Les charnières sont en polyamide fibre de verre 30%, les broches sont en inox A4 AISI-316.

NEW

Kunststoff-Scharnier, asymmetrisch / A4-AISI 316 / PA
Plastic hinge, asymmetrical / Charnière en plastique, asymétrique

815081

Artikel-Nr. Item-no.	L	L1	B	H	A	A1	A2	S	BD	Box	*€/Stück *€/piece
815081340 60	60	20	40	10,2	19	13,0	25	5,2	5,3	6	5,20
815081340 80	80	20	40	10,2	38	13,5	25	5,2	5,3	2	6,70
815081350 75	75	25	50	11,9	24	15,5	30	5,9	6,4	2	7,80
815081360 90	90	30	60	13,5	30	18,0	36	6,5	6,4	2	10,80

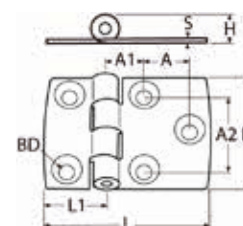

Die Scharniere bestehen aus Polyamid mit 30% Glasfaseranteil. Die Stifte bestehen aus Edelstahl A4 AISI-316.

The hinges are made of polyamide with 30% of glass fibre. The pins are made of stainless steel A4 AISI-316.

Les charnières sont en polyamide fibre de verre 30%, les broches sont en inox A4 AISI-316.

6

Scharniere, Griffe, Haken und Ringe

Hinges, handles, hooks and rings

Charnières, poignées, crochets et anneaux

8952

Scharnier / A2-AISI 304
Hinge / Charnière

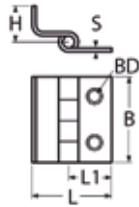

Artikel-Nr. Item-no.	L	L1	B	H	S	BD	Box	*€/Stück *€/piece
8952235 38	35	15	38	20	2	5,3	4	7,90

816005

Scharnier / A4-AISI 316
Hinge / Charnière

NEW

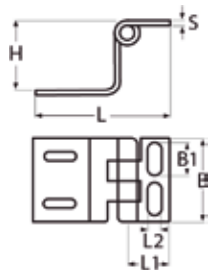

Artikel-Nr. Item-no.	L	L1	L2	B	B1	H	S	Box	*€/Stück *€/piece
816005444 40	44	16	4,4	40	14,8	20,5	2	6	5,60
816005452 40	52	22	4,6	40	15,0	20,5	2	6	6,60

814160

Scharnier / A2-AISI 304
Hinge / Charnière

MarineTown

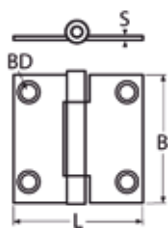

Artikel-Nr. Item-no.	L	B	S	BD	Box	*€/Stück *€/piece
814160250 50	50	50	2	7	4	12,30

814161

Scharnier / A2-AISI 304
Hinge / Charnière

MarineTown

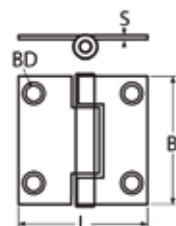

Artikel-Nr. Item-no.	L	B	S	BD	Box	*€/Stück *€/piece
814161250 50	50	50	2	7	4	14,30

Scharniere, Griffe, Haken und Ringe

Hinges, handles, hooks and rings
Charnières, poignées, crochets et anneaux

6



Scharnier / A2-AISI 304
Hinge / Charnière

8569

Artikel-Nr. Item-no.	L	B	H	S	BD	Box	*€/Stück *€/piece
8569238 38	38	38	9	2	5,4	4	12,40
8569268 38	68	38	9	2	5,4	4	15,90

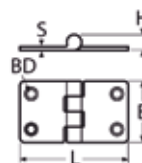

Scharnier / A2-AISI 304
Hinge / Charnière

8568

Artikel-Nr. Item-no.	L	L1	B	H	S	BD	Box	*€/Stück *€/piece
8568258 38	58	40	38	9	2	5,5	4	13,20
8568268 38	68	49	38	9	2	5,5	4	14,50

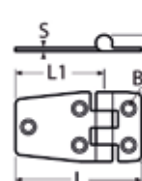

NEW

Scharnier / A4-AISI 316
Hinge / Charnière

815180

Artikel-Nr. Item-no.	L	B	A	A1	A2	S	BD	Box	*€/Stück *€/piece
815180455 40	55	40	19	9,5	18	1,5	4,5	2	3,00

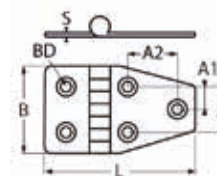

NEW

Scharnier / A4-AISI 316
Hinge / Charnière

815181

Artikel-Nr. Item-no.	L	B	A	A1	A2	S	BD	Box	*€/Stück *€/piece
815181470 40	70	40	19	9,5	18	1,5	4,7	2	3,20

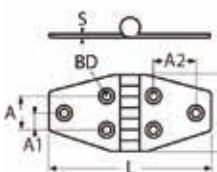

NEW

Scharnier / A4-AISI 316
Hinge / Charnière

815185

Artikel-Nr. Item-no.	L	B	A	A1	A2	S	BD	Box	*€/Stück *€/piece
815185495 60	95	60	38	19	19	2	5,5	2	7,00

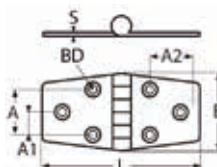

6

Scharniere, Griffe, Haken und Ringe

Hinges, handles, hooks and rings

Charnières, poignées, crochets et anneaux

8577

Scharnier / A2-AISI 304
Hinge / Charnière

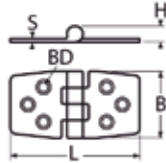

Artikel-Nr. Item-no.	L	B	H	S	BD	Box	*€/Stück *€/piece
8577275 38	75	38	9	2	5,5	4	13,60
8577297 38	97	38	9	2	5,5	4	17,10

8578

Scharnier / A2-AISI 304
Hinge / Charnière

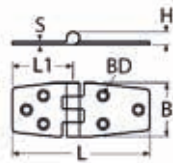

Artikel-Nr. Item-no.	L	L1	B	H	S	BD	Box	*€/Stück *€/piece
8578287 38	87	38	38	9	2	5,5	4	9,40
8578297 38	97	40	38	9	2	5,5	4	11,30

8906

Scharnier / A2-AISI 304
Hinge / Charnière

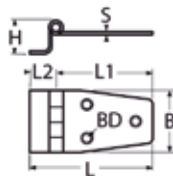

Artikel-Nr. Item-no.	L	L1	L2	B	H	S	BD	Box	*€/Stück *€/piece
8906265 3821	65	49	16	38	21	2	4,8	4	8,40
8906265 3835	65	49	16	38	35	2	4,8	4	9,00

8576

Scharnier / A2-AISI 304
Hinge / Charnière

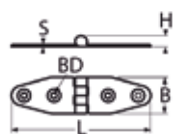

Artikel-Nr. Item-no.	L	B	H	S	BD	Box	*€/Stück *€/piece
85762100 28	100	28	9	2	5,5	4	14,70

Scharniere, Griffe, Haken und Ringe

Hinges, handles, hooks and rings
Charnières, poignées, crochets et anneaux

6

Scharnier / A2-AISI 304
Hinge / Charnière

815039

Artikel-Nr. Item-no.	L	B	A	S	BD	Box	*€/Stück *€/piece
815039275 20	75	20	17	1,5	5	10	1,90

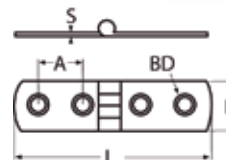

Scharnier / A2-AISI 304
Hinge / Charnière

815040

Artikel-Nr. Item-no.	L	B	A	S	BD	Box	*€/Stück *€/piece
815040280 20	80	20	17	1,5	4,5	10	2,00

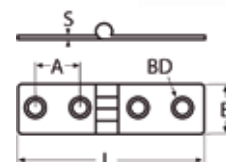

Scharnier / A2-AISI 304
Hinge / Charnière

8570

Artikel-Nr. Item-no.	L	B	H	S	BD	Box	*€/Stück *€/piece
85702145 38	145	38	9	2	5,5	4	9,10

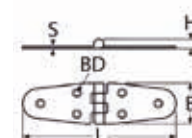

Scharnier / A2-AISI 304
Hinge / Charnière

8430

Artikel-Nr. Item-no.	Ausführung Type	L	B	H	A	A1	S	BD	Box	*€/Stück *€/piece
84302180 40A	A	180	40	9	40	24	2	5,3	4	17,60
84302180 40B	B	180	40	9	40	24	2	5,3	4	17,60

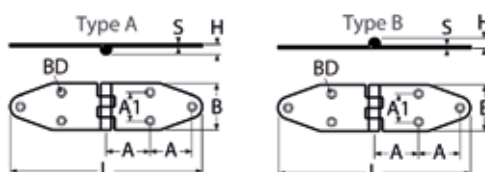

6

Scharniere, Griffe, Haken und Ringe

Hinges, handles, hooks and rings

Charnières, poignées, crochets et anneaux

815182

Scharnier / A4-AISI 316
Hinge / Charnière

NEW

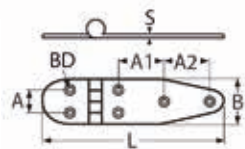

Artikel-Nr. Item-no.	L	B	A	A1	A2	S	BD	Box	*€/Stück *€/piece
8151824130 40	130	40	19	33	32	1,5	4,6	2	4,30

8429

Scharnier / A2-AISI 304
Hinge / Charnière



84292129 40A



84292120 40B

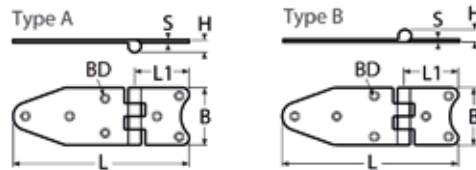

Artikel-Nr. Item-no.	Ausführung Type	L	L1	B	H	S	BD	Box	*€/Stück *€/piece
84292129 40A	A	129	38	40	9	2	5	4	9,30
84292129 40B	B	129	38	40	9	2	5	4	9,30

8572

Scharnier / A2-AISI 304
Hinge / Charnière

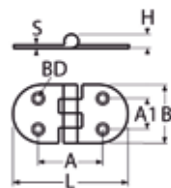

Artikel-Nr. Item-no.	L	B	H	A	A1	S	BD	Box	*€/Stück *€/piece
8572275 38	75	38	9	39,5	19,8	2	5,5	4	6,80

815183

Scharnier / A4-AISI 316
Hinge / Charnière

NEW

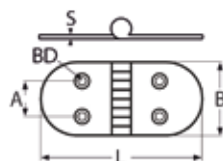

Artikel-Nr. Item-no.	L	B	A	S	BD	Box	*€/Stück *€/piece
815183476 40	76	40	19	1,5	4,8	2	3,00

Scharniere, Griffe, Haken und Ringe

Hinges, handles, hooks and rings
Charnières, poignées, crochets et anneaux

6

Scharnier / A2-AISI 304
Hinge / Charnière

8904

Artikel-Nr. Item-no.	L	L1	B	S	BD	Box	*€/Stück *€/piece
8904270 38	70	35	38	2	4,5	4	6,80

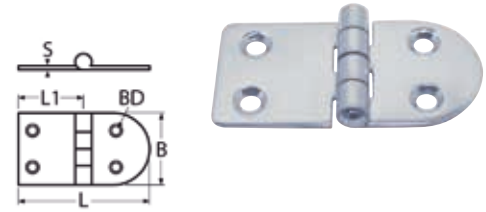

Scharnier / A2-AISI 304
Hinge / Charnière

8571

Artikel-Nr. Item-no.	L	L1	B	H	S	BD	Box	*€/Stück *€/piece
85712110 38	110	38	38	9	2	5,5	4	14,20

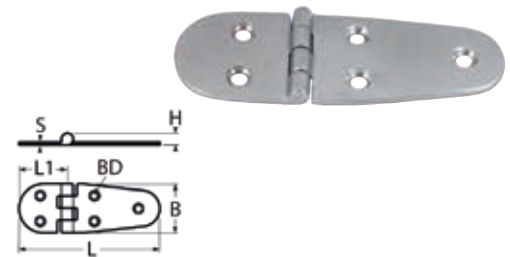

Scharnier / A2-AISI 304
Hinge / Charnière

8900

Artikel-Nr. Item-no.	L	B	S	BD	Box	*€/Stück *€/piece
89002102 27	103	27	2	3,8	4	6,20

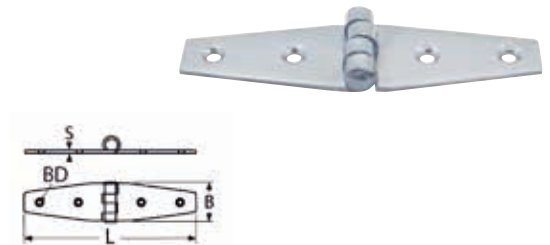

Scharnier / A2-AISI 304
Hinge / Charnière

8981

Artikel-Nr. Item-no.	L	L1	B	S	BD	Box	*€/Stück *€/piece
89812135 27	135	50	27	2	3,8	4	8,50

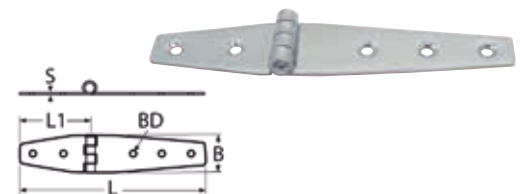

6

Scharniere, Griffe, Haken und Ringe

Hinges, handles, hooks and rings

Charnières, poignées, crochets et anneaux

8982

Scharnier / A2-AISI 304
Hinge / Charnière

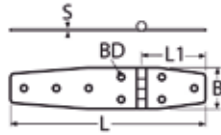

Artikel-Nr. Item-no.	L	L1	B	S	BD	Box	*€/Stück *€/piece
89822180 38	180	60	38	2	5,3	4	12,00

8575

Scharnier / A2-AISI 304
Hinge / Charnière

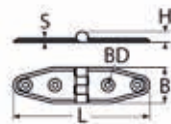
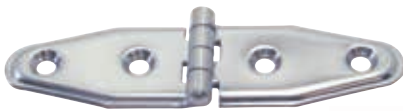

Artikel-Nr. Item-no.	L	B	H	S	BD	Box	*€/Stück *€/piece
85752105 28	105	28	8	3	5,3	4	5,20

8574

Scharnier / A2-AISI 304
Hinge / Charnière

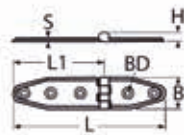

Artikel-Nr. Item-no.	L	L1	B	H	S	BD	Box	*€/Stück *€/piece
85742133 28	133	80	28	8	3	5,3	4	6,50

8573

Scharnier / A2-AISI 304
Hinge / Charnière

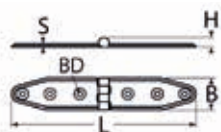

Artikel-Nr. Item-no.	L	B	H	S	BD	Box	*€/Stück *€/piece
85732160 28	160	28	8	3	5,3	4	7,20

Scharniere, Griffe, Haken und Ringe

Hinges, handles, hooks and rings
Charnières, poignées, crochets et anneaux

6

Scharnier, oval / A4-AISI 316
Oval hinge / Charnière, ovale

814941

Artikel-Nr. Item-no.	L	B	A	A1	S	BD	Box	*€/Stück *€/piece
814941457 75	57	75	33	33	2	5,5	4	7,60

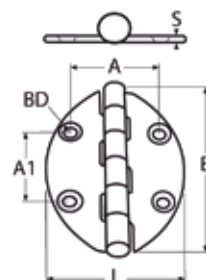

NEW

Scharnier, rund / A4-AISI 316
Hinge, round / Charnière, ronde

815178

Artikel-Nr. Item-no.	L	B	A	S	BD	Box	*€/Stück *€/piece
815178464	64	64	25	4	6,4	2	10,70

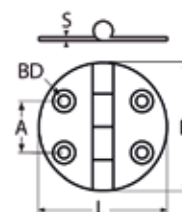

Scharnier, oval / A2-AISI 304
Oval hinge / Charnière, ovale

8902

Artikel-Nr. Item-no.	L	B	A	A1	S	BD	Box	*€/Stück *€/piece
8902267 48	67	48	38	23	2	5,3	4	6,90

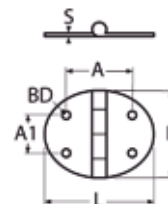

Scharnier, oval / A2-AISI 304
Oval hinge / Charnière, ovale

8903

Artikel-Nr. Item-no.	L	B	S	BD	Box	*€/Stück *€/piece
8903251 35	51	35	2	5,3	4	4,80

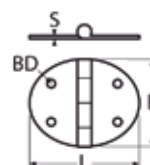

6

Scharniere, Griffe, Haken und Ringe

Hinges, handles, hooks and rings

Charnières, poignées, crochets et anneaux

814881

Scharnier, oval / A2-AISI 304
Oval hinge / Charnière, ovale

NEW

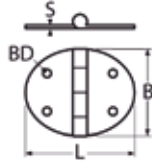

Artikel-Nr. Item-no.	L	B	S	BD	Box	*€/Stück *€/piece
814881251 35	51	35	1,5	4,3	5	3,40

815083

Scharnier / A4-AISI 316
Hinge / Charnière

NEW

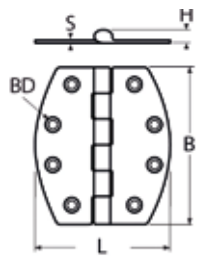

Artikel-Nr. Item-no.	L	B	H	S	BD	Box	*€/Stück *€/piece
815083498 100	98	100	12,5	4	7,1	1	35,80

8567

Scharnier / A4-AISI 316
Hinge / Charnière

 **MarineTown**

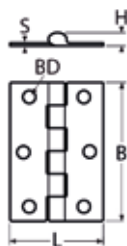

Artikel-Nr. Item-no.	L	B	H	S	BD	Box	*€/Stück *€/piece
85674050 35	35	50	7	1,5	3,2	4	7,60
85674062 40	40	62	7	1,5	3,2	4	11,80
85674077 50	50	77	7	1,5	6,0	4	13,60
85674100 55	55	100	7	1,5	6,4	4	15,00

814796

Scharnier / A2-AISI 304
Hinge / Charnière

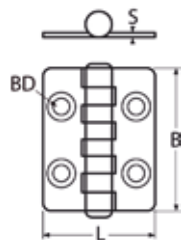

Artikel-Nr. Item-no.	L	B	S	BD	Box	*€/Stück *€/piece
814796230 40	30	40	1,5	4,5	10	2,10

Scharniere, Griffe, Haken und Ringe

Hinges, handles, hooks and rings
Charnières, poignées, crochets et anneaux

6

Scharnier / A2-AISI 304
Hinge / Charnière

814797

Artikel-Nr. Item-no.	L	B	S	A	A1	BD	Box	*€/Stück *€/piece
814797240 40	40	40	1,5	25	19	4,5	10	2,30

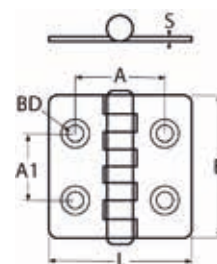

Scharnier / A2-AISI 304
Hinge / Charnière

814798

Artikel-Nr. Item-no.	L	B	S	BD	Box	*€/Stück *€/piece
814798240 60	40	60	1,5	5,5	10	3,50

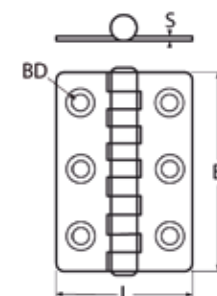

Scharnier / A2-AISI 304
Hinge / Charnière

814799

Artikel-Nr. Item-no.	L	B	S	BD	Box	*€/Stück *€/piece
814799250 60	50	60	1,5	5,5	10	3,50

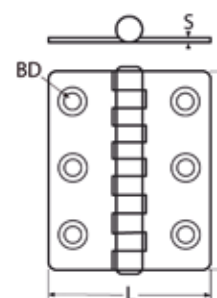

Scharnier / A2-AISI 304
Hinge / Charnière

814800

Artikel-Nr. Item-no.	L	B	S	BD	Box	*€/Stück *€/piece
814800260 60	60	60	1,5	5,5	10	2,90

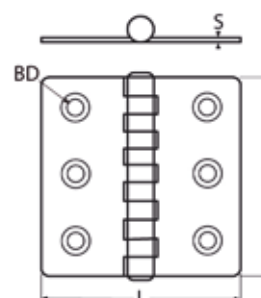

6

Scharniere, Griffe, Haken und Ringe

Hinges, handles, hooks and rings

Charnières, poignées, crochets et anneaux

814801

Scharnier / A2-AISI 304
Hinge / Charnière

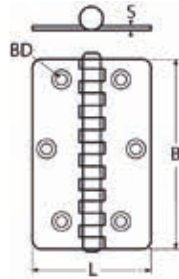

Artikel-Nr. Item-no.	L	B	S	BD	Box	*€/Stück *€/piece
814801250 80	50	80	1,5	5,5	10	3,90

814802

Scharnier / A2-AISI 304
Hinge / Charnière

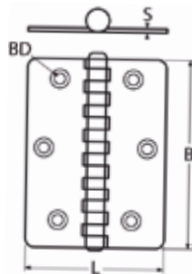

Artikel-Nr. Item-no.	L	B	S	BD	Box	*€/Stück *€/piece
814802260 80	60	80	1,5	5,5	10	3,90

815164

Scharnier / A4-AISI 316
Hinge / Charnière

NEW

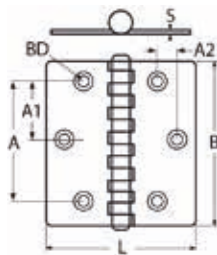

Artikel-Nr. Item-no.	L	B	A	A1	A2	S	BD	Box	*€/Stück *€/piece
815164470 80	70	80	60	30	10	1,5	5,4	2	4,50
815164480 80	80	80	60	30	10	1,5	5,4	2	4,80

815165

Scharnier / A4-AISI 316
Hinge / Charnière

NEW

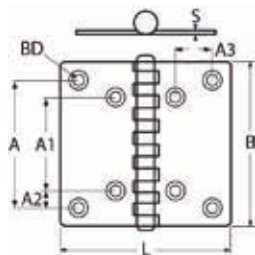

Artikel-Nr. Item-no.	L	B	A	A1	A2	A3	S	BD	Box	*€/Stück *€/piece
8151654100 100	100	100	75	60	8	25	2	6,4	2	10,80

Scharniere, Griffe, Haken und Ringe

Hinges, handles, hooks and rings
Charnières, poignées, crochets et anneaux

6

Scharnier / A2-AISI 304 / A4-AISI 316
Hinge / Charnière

814908

Artikel-Nr. A2 Item-no. A2	Artikel-Nr. A4 Item-no. A4	L	B	A	A1	A2	S	BD	Box	*€/Stück A2 *€/piece A2	*€/Stück A4 *€/piece A4
8149082085 30	8149084085 30	85	30	66,7	19,9	17,6	1,5	5,0	10	2,50	4,30
8149082100 40	8149084100 40	100	40	75,0	25,5	25,0	1,5	5,4	10	2,80	4,60

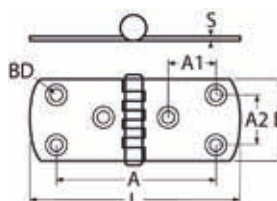

Scharnier / A2-AISI 304
Hinge / Charnière

815041

Artikel-Nr. Item-no.	L	B	A	A1	A2	S	BD	Box	*€/Stück *€/piece
8150412090 30	90	30	16	17,5	65	1,5	5,5	10	2,10
8150412100 40	100	40	25	24,5	75	1,5	5,5	10	2,20

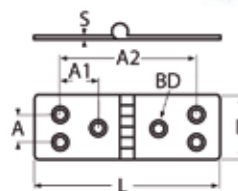

Scharnier / A2-AISI 304
Hinge / Charnière

814937

Artikel-Nr. Item-no.	L	B	A	A1	S	BD	Box	*€/Stück *€/piece
814937225 30	25,0	30	14,9	20,3	0,8	3	10	2,00
8149372285 30	28,5	30	19,8	20,3	0,8	3	10	2,10
814937235 40	35,0	40	21,5	26,7	0,8	4	10	2,20
814937240 40	40,0	40	22,5	27,1	0,8	4	10	2,30

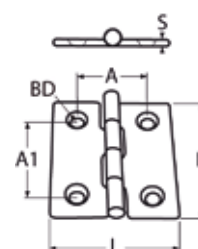

Scharnier / A2-AISI 304
Hinge / Charnière

814938

Artikel-Nr. Item-no.	L	B	S	BD	Box	*€/Stück *€/piece
814938240 50	40	50	0,8	4	10	2,10
814938250 50	50	50	0,8	4	10	2,40
814938250 60	50	60	0,8	4	10	2,60
814938253 70	53	70	0,8	4	10	2,80

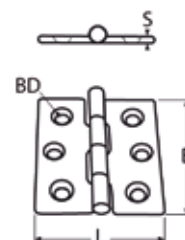

6

Scharniere, Griffe, Haken und Ringe

Hinges, handles, hooks and rings

Charnières, poignées, crochets et anneaux

815042

Scharnier / A4-AISI 316
Hinge / Charnière

NEW

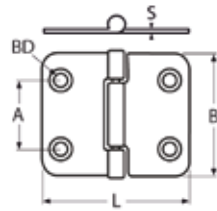

Artikel-Nr. Item-no.	L	B	A	S	BD	Box	*€/Stück *€/piece
8150424066 55	66	55	30	4	5,5	2	6,10

815127

Scharnier / A4-AISI 316
Hinge / Charnière

NEW

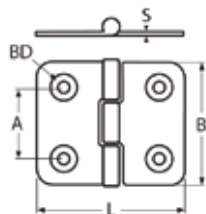

Artikel-Nr. Item-no.	L	B	A	S	BD	Box	*€/Stück *€/piece
815127465 65	65	65	38	4	6,5	2	14,70

8924

Scharnier / A4-AISI 316
Hinge / Charnière

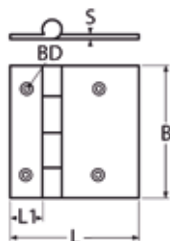

Artikel-Nr. Item-no.	L	L1	B	S	BD	Box	*€/Stück *€/piece
8924452 61	52	19	61	4	6,3	4	11,60

8925

Scharnier mit Gewinde / A4-AISI 316
Hinge with thread / Charnière avec filetage

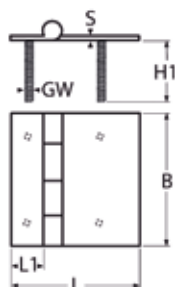

Artikel-Nr. Item-no.	L	L1	B	H1	S	GW	Box	*€/Stück *€/piece
8925452 61	52	19	61	45	4	M6	2	15,80

Scharniere, Griffe, Haken und Ringe

Hinges, handles, hooks and rings
Charnières, poignées, crochets et anneaux

6

Scharnier / A4-AISI 316 Hinge / Charnière

8926

Artikel-Nr. Item-no.	L	L1	B	A	A1	S	BD	Box	*€/Stück *€/piece
8926480 65	80	33	65	48	33	4	6,3	2	15,60

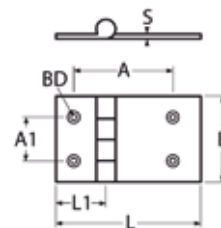

Scharnier mit Gewinde / A4-AISI 316 Hinge with thread / Charnière avec filetage

8927

Artikel-Nr. Item-no.	L	L1	B	H1	S	GW	Box	*€/Stück *€/piece
8927480 65	80	33	65	45	4	M6	2	36,30



Scharnier / A4-AISI 316 Hinge / Charnière

8928

Artikel-Nr. Item-no.	L	L1	B	S	BD	Box	*€/Stück *€/piece
8928470 40	70	30	40	3,5	5,7	4	14,10

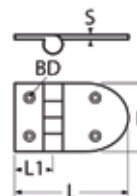

Scharnier mit Gewinde / A4-AISI 316 Hinge with thread / Charnière avec filetage

8929

Artikel-Nr. Item-no.	L	L1	B	H1	S	GW	Box	*€/Stück *€/piece
8929470 40	70	30	40	45	3,5	M6	2	16,20



6

Scharniere, Griffe, Haken und Ringe

Hinges, handles, hooks and rings

Charnières, poignées, crochets et anneaux

8920

Scharnier / A4-AISI 316

Hinge / Charnière

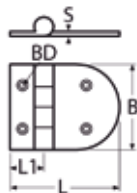

Artikel-Nr. Item-no.	L	L1	B	S	BD	Box	*€/Stück *€/piece
8920472 65	72	21	65	4	6	2	15,50

8921

Scharnier mit Gewinde / A4-AISI 316

Hinge with thread / Charnière avec filetage

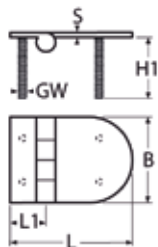

Artikel-Nr. Item-no.	L	L1	B	H1	S	GW	Box	*€/Stück *€/piece
8921472 65	72	21	65	45	4	M6	2	23,50

8918

Scharnier / A4-AISI 316

Hinge / Charnière

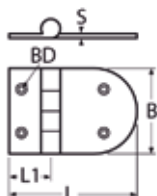

Artikel-Nr. Item-no.	L	L1	B	S	BD	Box	*€/Stück *€/piece
8918483 65	83	32	65	4	6,3	2	16,00

8919

Scharnier mit Gewinde / A4-AISI 316

Hinge with thread / Charnière avec filetage

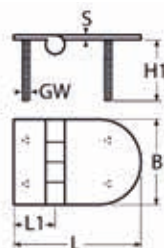

Artikel-Nr. Item-no.	L	L1	B	H1	S	GW	Box	*€/Stück *€/piece
8919483 65	83	32	65	45	4	M6	2	26,10

Scharniere, Griffe, Haken und Ringe

Hinges, handles, hooks and rings
Charnières, poignées, crochets et anneaux

6

Scharnier / A4-AISI 316
Hinge / Charnière

8922

Artikel-Nr. Item-no.	L	L1	B	S	BD	Box	*€/Stück *€/piece
89224103 65	103	21	65	4	6,3	2	19,50

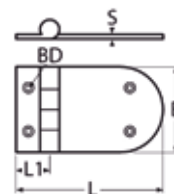

Scharnier mit Gewinde / A4-AISI 316
Hinge with thread / Charnière avec filetage

8923

Artikel-Nr. Item-no.	L	L1	B	H1	S	A	A1	GW	Box	*€/Stück *€/piece
89234103 65	103	21	65	45	4	70	35	M6	2	22,50



Scharnier / A4-AISI 316
Hinge / Charnière

8932

Artikel-Nr. Item-no.	L	L1	B	S	A	A1	A2	BD	Box	*€/Stück *€/piece
89324127 65	127	32	65	4	44	46	35	6,3	2	25,10

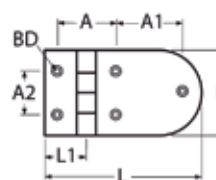

Scharnier mit Gewinde / A4-AISI 316
Hinge with thread / Charnière avec filetage

8933

Artikel-Nr. Item-no.	L	L1	B	H1	S	GW	Box	*€/Stück *€/piece
89334127 65	127	32	65	45	4	M6	2	42,80



6

Scharniere, Griffe, Haken und Ringe

Hinges, handles, hooks and rings

Charnières, poignées, crochets et anneaux

8910

Scharnier / A4-AISI 316

Hinge / Charnière

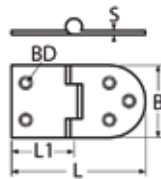

Artikel-Nr. Item-no.	L	L1	B	S	BD	Box	*€/Stück *€/piece
8910476 40	76	30	40	4	5,3	2	12,00

8911

Scharnier mit Gewinde / A4-AISI 316

Hinge with thread / Charnière avec filetage

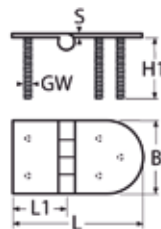

Artikel-Nr. Item-no.	L	L1	B	H1	S	GW	Box	*€/Stück *€/piece
8911476 40	76	30	40	45	4	M6	2	18,50

8912

Scharnier / A4-AISI 316

Hinge / Charnière

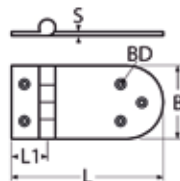

Artikel-Nr. Item-no.	L	L1	B	S	BD	Box	*€/Stück *€/piece
89124134 65	134	21	65	4	6,4	2	21,80

8913

Scharnier mit Gewinde / A4-AISI 316

Hinge with thread / Charnière avec filetage

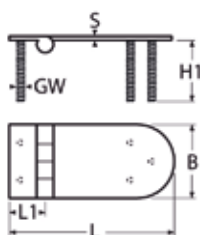

Artikel-Nr. Item-no.	L	L1	B	H1	S	GW	Box	*€/Stück *€/piece
89134134 65	134	21	65	45	4	M6	2	38,10

Scharniere, Griffe, Haken und Ringe

Hinges, handles, hooks and rings
Charnières, poignées, crochets et anneaux

6

Scharnier / A4-AISI 316
Hinge / Charnière

8914

Artikel-Nr. Item-no.	L	L1	B	S	BD	Box	*€/Stück *€/piece
89144146 65	146	51	65	4	6,3	2	29,20

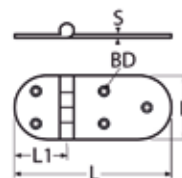

Scharnier mit Gewinde / A4-AISI 316
Hinge with thread / Charnière avec filetage

8915

Artikel-Nr. Item-no.	L	L1	B	H1	S	GW	Box	*€/Stück *€/piece
89154146 65	146	51	65	45	4	M6	2	43,80

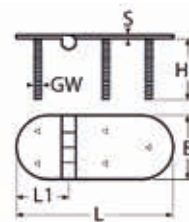

Scharnier / A4-AISI 316
Hinge / Charnière

8930

Artikel-Nr. Item-no.	L	L1	B	S	BD	Box	*€/Stück *€/piece
89304126 40	126	40	40	3,5	5,2	2	14,70

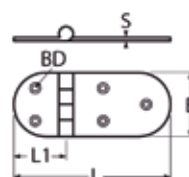

Scharnier mit Gewinde / A4-AISI 316
Hinge with thread / Charnière avec filetage

8931

Artikel-Nr. Item-no.	L	L1	B	H1	S	GW	Box	*€/Stück *€/piece
89314126 40	126	40	40	45	3,5	M6	2	37,00

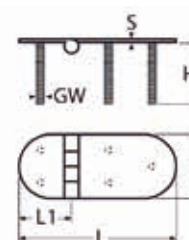

6

Scharniere, Griffe, Haken und Ringe

Hinges, handles, hooks and rings

Charnières, poignées, crochets et anneaux

814125

Scharnier / A4-AISI 316

Hinge / Charnière

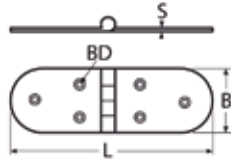

Artikel-Nr. Item-no.	L	B	S	BD	Box	*€/Stück *€/piece
8141254190 95	190	65	4	6,3	2	35,40

8917

Scharnier mit Gewinde / A4-AISI 316

Hinge with thread / Charnière avec filetage

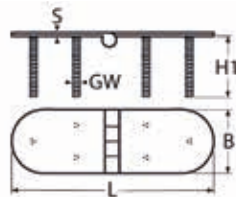

Artikel-Nr. Item-no.	L	B	H1	S	GW	Box	*€/Stück *€/piece
89174190 65	190	65	45	4	M6	2	52,90

8674

Scharnier mit Abdeckung / A4-AISI 316

Covered hinge / Charnière avec cache de vis

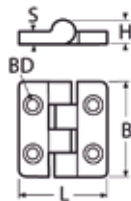

NEW

Artikel-Nr. Item-no.	L	B	H	S	BD	Box	*€/Stück *€/piece
86744036 36	36	36	9	2	6	4	19,10
86744036 36 Cover						Ersatzabdeckung, selbstklebend Replacement cover, self-adhesive	2 5,00

8675

Scharnier mit Abdeckung / A4-AISI 316

Covered hinge / Charnière avec cache de vis

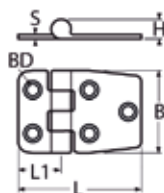

NEW

Artikel-Nr. Item-no.	L	L1	B	H	S	BD	Box	*€/Stück *€/piece
86754057 37	57	18	37	9	2	6	4	19,30
86754057 37 Cover							Ersatzabdeckung, selbstklebend Replacement cover, self-adhesive	2 5,00

Scharniere, Griffe, Haken und Ringe

Hinges, handles, hooks and rings

Charnières, poignées, crochets et anneaux

6



Scharnier mit Abdeckung / A4-AISI 316

Covered hinge / Charnière avec cache de vis

8676

Artikel-Nr. Item-no.	L	B	H	S	A	A1	A2	BD	Box	*€/Stück *€/piece
86764074 40	74	40	10	2	62	26	23	5,4	4	21,80
86764074 40 Cover	Ersatzabdeckung, selbstklebend Replacement cover, self-adhesive								2	5,00

NEW

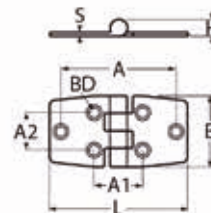

Scharnier mit Abdeckung / Plastik, schwarz

Covered hinge, Plastic, black / Charnière avec cache de vis en plastique, noir

814738

Artikel-Nr. Item-no.	L	B	H	S	BD	Box	*€/Stück *€/piece
814738379 41	79	41	11	4	4,5	4	8,90

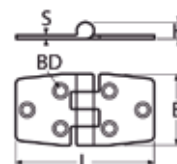

Scharnier mit Abdeckung / A4-AISI 316

Covered hinge / Charnière avec cache de vis

8677

Artikel-Nr. Item-no.	L	B	H	S	BD	Box	*€/Stück *€/piece
86774075 74	74	75	9	2	7,5	4	34,70
86774075 74 Cover	Ersatzabdeckung, selbstklebend Replacement cover, self-adhesive					2	5,00

NEW

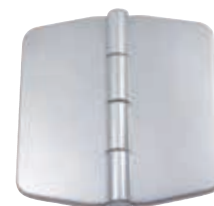
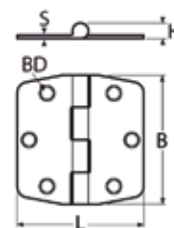

Scharnier mit Abdeckung / A4-AISI 316

Covered hinge / Charnière avec cache de vis

8678

Artikel-Nr. Item-no.	L	B	H	S	BD	Box	*€/Stück *€/piece
86784065 65	65	65	10	2,6	5,5	4	29,90
86784065 65 Cover	Ersatzabdeckung, selbstklebend Replacement cover, self-adhesive					2	5,00

NEW

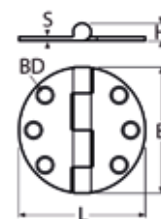

6

Scharniere, Griffe, Haken und Ringe

Hinges, handles, hooks and rings

Charnières, poignées, crochets et anneaux

Scharniere mit Schnapp-Abdeckung

Hinges with snap-down cover / Charnière avec couvercle à déclic



814820

Scharnier mit Schnappabdeckung / A4-AISI 316

Hinge with snap-down cover / Charnière avec couvercle à déclic

MarineTown

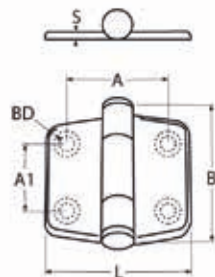

Artikel-Nr. Item-no.	L	B	S	A	A1	BD	Box	*€/Stück *€/piece
814820442 45	42	45	2	28	23	6	4	23,50

Schnapp-Abdeckung mit einem Schlitz-Schraubendreher öffnen

Open the cover with a flat-head screwDriver.

Ouvrir le couvercle encliquetable à l'aide d'un tournevis à fente.

814822

Scharnier mit Schnappabdeckung / A4-AISI 316

Hinge with snap-down cover / Charnière avec couvercle à déclic

MarineTown

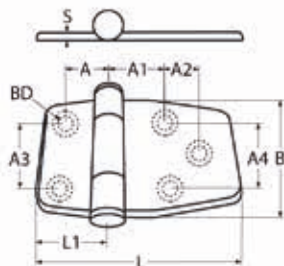

Artikel-Nr. Item-no.	L	L1	B	A	A1	A2	A3	A4	S	BD	Box	*€/Stück *€/piece
814822460 45	60	19	45	14	19	8,5	23	20	2	6	4	26,70

Schnapp-Abdeckung mit einem Schlitz-Schraubendreher öffnen

Open the cover with a flat-head screwDriver.

Ouvrir le couvercle encliquetable à l'aide d'un tournevis à fente.



814821

Scharnier mit Schnappabdeckung / A4-AISI 316

Hinge with snap-down cover / Charnière avec couvercle à déclic

MarineTown

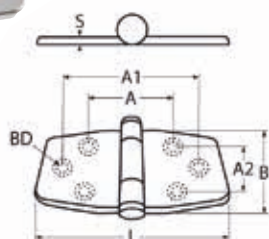

Artikel-Nr. Item-no.	L	B	A	A1	A2	S	BD	Box	*€/Stück *€/piece
814821478 45	78	45	38	55	20	2	9	4	32,80

Schnapp-Abdeckung mit einem Schlitz-Schraubendreher öffnen

Open the cover with a flat-head screwDriver.

Ouvrir le couvercle encliquetable à l'aide d'un tournevis à fente.

Scharniere, Griffe, Haken und Ringe

Hinges, handles, hooks and rings

Charnières, poignées, crochets et anneaux

6



Scharnier mit Schnappabdeckung / A4-AISI 316

Hinge with snap-down cover / Charnière avec couvercle à dé clic

814824

Artikel-Nr. Item-no.	L	B	A	A1	A2	S	BD	Box	*€/Stück *€/piece
814824478 83	78	83	39	52	54	2	6,5	4	47,00

Schnapp-Abdeckung mit einem Schlitz-Schraubendreher öffnen
Open the cover with a flat-head screwDriver.
Ouvrir le couvercle encliquetable à l'aide d'un tournevis à fente.

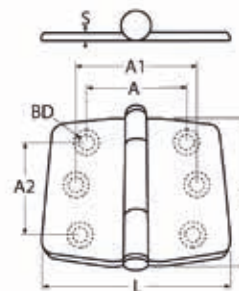

Scharnier mit Schnappabdeckung / A4-AISI 316

Hinge with snap-down cover / Charnière avec couvercle à dé clic

814823

Artikel-Nr. Item-no.	L	B	A	A1	A2	S	BD	Box	*€/Stück *€/piece
814823470 65	65	70	38	42	35,9	2	6,5	4	32,10

Schnapp-Abdeckung mit einem Schlitz-Schraubendreher öffnen
Open the cover with a flat-head screwDriver.
Ouvrir le couvercle encliquetable à l'aide d'un tournevis à fente.

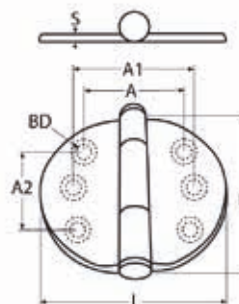

Scharniere mit Halteautomatik

Holding hinges / Charnières à arrêt automatique



Technische Informationen
zum Scharnier mit Halteautomatik
Technical information about
holding hinge
Informations techniques
sur le charnière arrêt automatique



Scharnier mit Halteautomatik / A4-AISI 316

Holding hinge / Charnière à arrêt automatique

814903

Artikel-Nr. Item-no.	L	B	A	A1	S	BD	Box	*€/Stück *€/piece
814903438 38	38	37	26,2	23	2	6	4	32,60

Haltekraft ca. 1,5±0,4Nm
Torque range ca. 1.5±0.4Nm
Force de maintien env. 1,5±0,4Nm

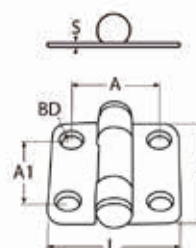

6

Scharniere, Griffe, Haken und Ringe

Hinges, handles, hooks and rings

Charnières, poignées, crochets et anneaux

814825

Scharnier mit Halteautomatik / A4-AISI 316
Holding hinge / Charnière à arrêt automatique

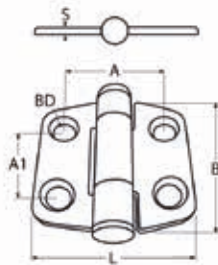

Artikel-Nr. Item-no.	L	B	A	A1	S	BD	Box	*€/Stück *€/piece
814825438 41	40	41	28	23	2	6	4	32,00

Haltekraft ca. $2,2 \pm 0,7$ Nm
Torque range ca. $2,2 \pm 0,7$ Nm
Force de maintien env. $2,2 \pm 0,7$ Nm

814826

Scharnier mit Halteautomatik / A4-AISI 316
Holding hinge / Charnière à arrêt automatique

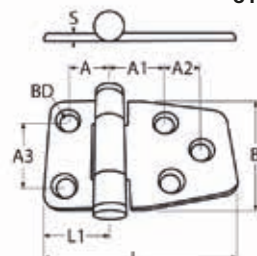

Artikel-Nr. Item-no.	L	L1	B	A	A1	A2	S	BD	Box	*€/Stück *€/piece
814826457 42	57	18	42	13,5	17,5	22,5	2	6	4	35,80

Haltekraft ca. $1,5 \pm 0,4$ Nm
Torque range ca. $1,5 \pm 0,4$ Nm
Force de maintien env. $1,5 \pm 0,4$ Nm

814827

Scharnier mit Halteautomatik / A4-AISI 316
Holding hinge / Charnière à arrêt automatique

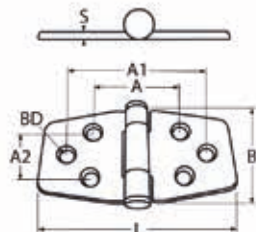

Artikel-Nr. Item-no.	L	B	A	A1	A2	S	BD	Box	*€/Stück *€/piece
814827476 42	76	42	35	56	20	2	6	4	37,40

Haltekraft ca. $1,6 \pm 0,4$ Nm
Torque range ca. $1,6 \pm 0,4$ Nm
Force de maintien env. $1,6 \pm 0,4$ Nm

814923

Scharnier mit Halteautomatik und kurzen Flügeln / A4-AISI 316
Holding hinge with short leaves / Charnière à arrêt automatique, languette courte

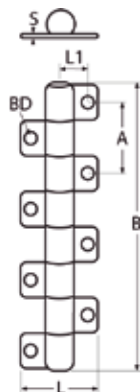

Artikel-Nr. Item-no.	L	L1	B	A	S	BD	Box	*€/Stück *€/piece
814923451 285	28,5	9,6	51	24	2	3,8	2	31,50
814923475 285	28,5	9,6	75	24	2	3,8	2	45,00
814923499 285	28,5	9,6	99	24	2	3,8	2	58,00
NEW 8149234123 285	28,5	9,6	123	24	2	3,8	2	76,80

814923451 285: Haltekraft ca. $1,9 \pm 0,4$ Nm · Torque range ca. $1,9 \pm 0,4$ Nm · Force de maintien env. $1,9 \pm 0,4$ Nm
814923475 285: Haltekraft ca. $3,1 \pm 0,6$ Nm · Torque range ca. $3,1 \pm 0,6$ Nm · Force de maintien env. $3,1 \pm 0,6$ Nm
814923499 285: Haltekraft ca. $4,1 \pm 0,7$ Nm · Torque range ca. $4,1 \pm 0,7$ Nm · Force de maintien env. $4,1 \pm 0,7$ Nm
8149234123 285: Haltekraft ca. $5,3 \pm 0,8$ Nm · Torque range ca. $5,3 \pm 0,8$ Nm · Force de maintien env. $5,3 \pm 0,8$ Nm

Scharniere, Griffe, Haken und Ringe

Hinges, handles, hooks and rings

Charnières, poignées, crochets et anneaux

6



Scharnier mit Halteautomatik und langen Flügeln / A4-AISI 316

Holding hinge with long leaves / Charnière à arrêt automatique, languette longue

814924

Artikel-Nr. Item-no.	L	L1	B	A	S	BD	Box	*€/Stück *€/piece
8149244538 45	45	17,5	53,8	25,4	2	4,7	2	35,00
8149244792 45	45	17,5	79,2	25,4	2	4,7	2	51,00
81492441046 45	45	17,5	104,6	25,4	2	4,7	2	63,00
81492441300 45	45	17,5	130,0	25,4	2	4,7	2	87,50

NEW

8149244538 45: Haltekraft ca. $2,0 \pm 0,5 \text{ Nm}$ · Torque range ca. $1,9 \pm 0,4 \text{ Nm}$ · Force de maintien env. $1,9 \pm 0,4 \text{ Nm}$
 8149244792 45: Haltekraft ca. $3,2 \pm 0,6 \text{ Nm}$ · Torque range ca. $3,2 \pm 0,6 \text{ Nm}$ · Force de maintien env. $3,2 \pm 0,6 \text{ Nm}$
 81492441046 45: Haltekraft ca. $4,3 \pm 0,7 \text{ Nm}$ · Torque range ca. $4,3 \pm 0,7 \text{ Nm}$ · Force de maintien env. $4,3 \pm 0,7 \text{ Nm}$
 81492441300 45: Haltekraft ca. $5,3 \pm 0,8 \text{ Nm}$ · Torque range ca. $5,3 \pm 0,8 \text{ Nm}$ · Force de maintien env. $5,3 \pm 0,8 \text{ Nm}$

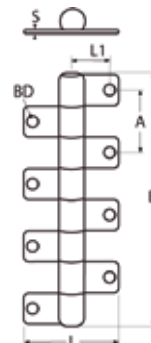

Scharnier, 2-tlg. / A4-AISI 316

Hinge 2-part / Charnière dégonflable, 2 parties

814033

Artikel-Nr. Item-no.	Ausführung Type	L	B	A	A1	S	BD	Box	*€/Stück *€/piece
814033437 37RE	Rechts Right / A droite	37	37	12,5	23	2,6	5,6	5	8,10
814033437 37LI	Links Left / A gauche	37	37	12,5	23	2,6	5,6	5	8,10



Abbildung links
Left type
Type de gauche



6

Motorhauben-Scharnier / A4-AISI 316

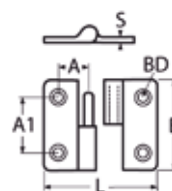
Motor box hinge / Charnière dégonflable

8239

Artikel-Nr. Item-no.	L	B	S	BD	Box	*€/Stück *€/piece
8239490 38	90	38	3	5,3	5	11,60

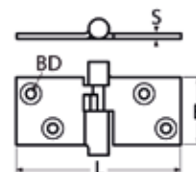

Türscharnier, 2-tlg. / A2-AISI 304

Door hinge, 2-part / Paumelle dégonflable, 2 parties

8512

Artikel-Nr. Item-no.	Ausführung Type	L	B	D	S	BD	Box	*€/Stück *€/piece
85122100 80RE	Rechts Right / A droite	82	98	14	3	6,8	2	20,90
85122100 80LI	Links Left / A gauche	82	98	14	3	6,8	2	20,90



Abbildung links
Left type
Type de gauche



6

Scharniere, Griffe, Haken und Ringe

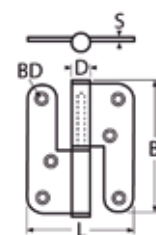
Hinges, handles, hooks and rings

Charnières, poignées, crochets et anneaux



814158

Scharnier, 180° / A4-AISI 316

Hinge, 180° / Charnière, 180°

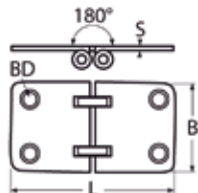

Artikel-Nr. Item-no.	L	B	S	BD	Box	*€/Stück *€/piece
814158471 40	71	40	2	5,5	5	14,50

8671

Scharnier / A4-AISI 316

Hinge / Charnière

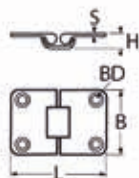

Artikel-Nr. Item-no.	L	B	H	S	BD	Box	*€/Stück *€/piece
86714052 42	52	42	8	2,6	5,5	5	25,60

8670

Scharnier / A4-AISI 316

Hinge / Charnière

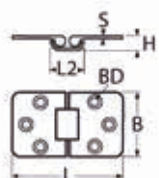

Artikel-Nr. Item-no.	L	L2	B	H	S	BD	Box	*€/Stück *€/piece
86704070 42	70	21	42	7,5	2,6	5,5	5	9,40

8897

Scharnier, 180° / A4-AISI 316

Hinge, 180° / Charnière, 180°

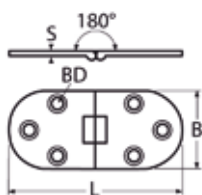

Artikel-Nr. Item-no.	L	B	S	BD	Box	*€/Stück *€/piece
8897466 30	66	30	2,5	4,3	5	12,50

Scharniere, Griffe, Haken und Ringe

Hinges, handles, hooks and rings
Charnières, poignées, crochets et anneaux

6

NEW

Tischscharnier / A4-AISI 316
Table hinge / Charnière de table

815179

Artikel-Nr. Item-no.	L	B	A	A1	A2	S	BD	Box	*€/Stück *€/piece
815179480 30	80	30	19	9,5	10	2	5,2	2	7,30

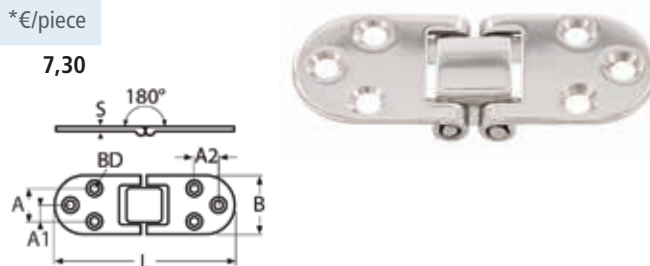

Scharnier / A2-AISI 304
Hinge / Charnière

8905

Artikel-Nr. Item-no.	L	L1	B	H	S	BD	Box	*€/Stück *€/piece
89052127 47	127	98	47	42	2,5	5,3	2	18,00

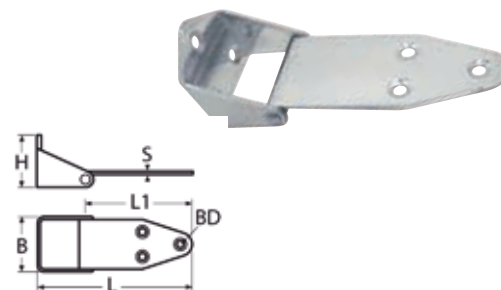

Scharnier / A4-AISI 316
Hinge / Charnière

8238

Artikel-Nr. Item-no.	L	B	H	S	BD	Box	*€/Stück *€/piece
8238474 65	74	65	30	6	5,3	2	22,00

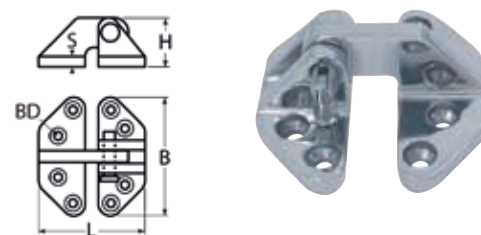

Anschweißscharnier, 2-tlg. / A2-AISI 304
Weld-on hinge, 2-part / Paumelle à souder, 2 parties

814752

Artikel-Nr. Item-no.	L	B	B1	S	Box	*€/Stück *€/piece
8147522066	16	66	27	2,0	2	4,10
8147522100	19	100	46	2,0	2	6,50
8147522120	19	120	55	2,0	2	8,70
8147522140	21	140	65	2,5	2	11,50

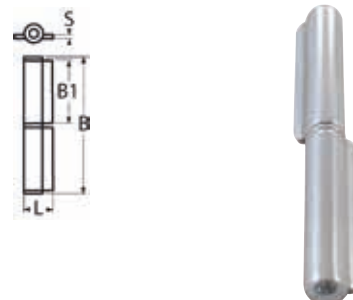

6

Scharniere, Griffe, Haken und Ringe

Hinges, handles, hooks and rings

Charnières, poignées, crochets et anneaux

814750

Anschweißscharnier 2-teilig mit herausnehmbarem Bolzen / A2-AISI 304

Weld-on hinge, 2-part with removable pin / Paumelle à souder, 2 parties, boulon amovible

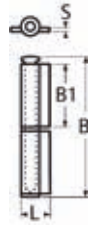

Artikel-Nr. Item-no.	L	B	B1	S	Box	*€/Stück *€/piece
8147502060	15	60	27	2,0	2	3,60
8147502080	15	80	37	2,0	2	4,30
8147502100	19	100	46	2,0	2	6,50
8147502120	19	120	55	2,0	2	8,80
8147502140	21	140	65	2,5	2	12,10

814751

Anschweißscharnier, 3-teilig mit herausnehmbarem Bolzen / A2-AISI 304

Weld-on hinge, 3-part with removable pin / Paumelle à souder, 3 parties, boulon amovible

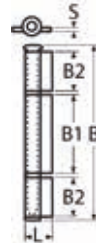

Artikel-Nr. Item-no.	L	B	B1	B2	S	Box	*€/Stück *€/piece
8147512100	19	100	46	22,0	2,0	2	8,60
8147512120	19	120	55	27,0	2,0	2	10,10
8147512140	21	140	65	32,5	2,5	2	14,20

814754

Anschweißscharnier, 3-tlg. mit langen Flügeln / A2-AISI 304

Weld-on hinge, 3-part with long leaves / Paumelle de grille à souder, 3 parties

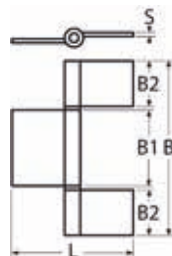

Artikel-Nr. Item-no.	L	B	B1	S	Box	*€/Stück *€/piece
8147542118	87	118	27	2	2	11,10

814753

Anschweißscharnier, 2-tlg. mit langen Flügeln / A2-AISI 304

Weld-on hinge, 2-part with long leavess / Paumelle de grille à souder, 2 parties



Typ links
Left type
Type à gauche

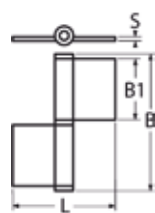

Artikel-Nr. Item-no.	Ausführung Type	L	B	B1	S	Box	*€/Stück *€/piece
8147532075 30RE	Rechts / Right	56	75	30	2,5	2	8,10
8147532093 40RE	Rechts / Right	71	93	40	2,5	2	8,80
8147532115 50RE	Rechts / Right	80	115	50	3,0	2	15,90
8147532135 60RE	Rechts / Right	80	135	60	3,0	2	19,50
8147532075 30LI	Links / Left	56	75	30	2,5	2	8,10
8147532093 40LI	Links / Left	71	93	40	2,5	2	8,80
8147532115 50LI	Links / Left	80	115	50	3,0	2	15,90
8147532135 60LI	Links / Left	80	135	60	3,0	2	19,50

Scharniere, Griffe, Haken und Ringe

Hinges, handles, hooks and rings
Charnières, poignées, crochets et anneaux

6

Scharnier mit 3 Flügeln / A4-AISI 316

Hinge with 3 leaves / Charnière triple

815013

Artikel-Nr. Item-no.	L	L1	L2	B	S	BD	Box	*€/Stück *€/piece
815013498	51	28	23	98	2,5	7	2	14,80

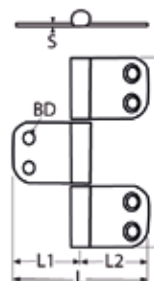

Scharnier / A2-AISI 304

Hinge / Charnière

8859

Artikel-Nr. Item-no.	L	B	S	BD	Box	*€/Stück *€/piece
8859285	60	85	1,5	7	5	8,40

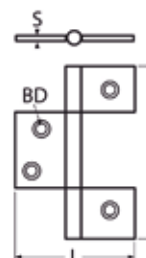

Überfallscharnier, abschließbar / A2-AISI 304

Lockable swivel hasp / Fermeture à cadenas

8428

Artikel-Nr. Item-no.	L	B	iD	BD	Box	*€/Stück *€/piece
8428271 24	67	24	7,8	4,4	5	17,20

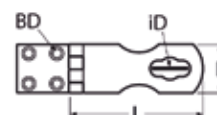

NEW

Überfallscharnier, verriegelbar, abschließbar / A4-AISI 316

Lockable swivel hasp / Fermeture à cadenas

815171

Artikel-Nr. Item-no.	L	B	BD	Box	*€/Stück *€/piece
815171475	75	25,5	4,7	2	20,50

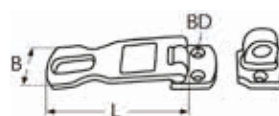

6

Scharniere, Griffe, Haken und Ringe

Hinges, handles, hooks and rings

Charnières, poignées, crochets et anneaux

815172

Überfallscharnier, abschließbar / A4-AISI 316

Lockable swivel hasp / Fermeture à cadenas

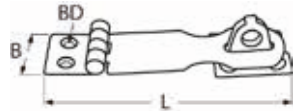

Artikel-Nr. Item-no.	L	B	BD	Box	*€/Stück *€/piece
8151724100	100	28	4,4	2	4,80

8588

Überfallscharnier mit Schloss / A2-AISI 304

Swivel hasp with lock / Fermeture avec serrure

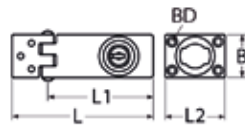
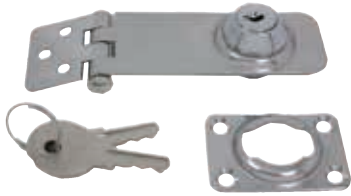

Artikel-Nr. Item-no.	L	L1	L2	B	BD	Box	*€/Stück *€/piece
8588230	98	78	42	30	4,8	1	20,90

8518

Überfallscharnier, abschließbar / A4-AISI 316

Lockable swivel hasp / Fermeture sauterelle

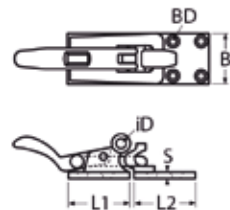

Artikel-Nr. Item-no.	L1	L2	B	iD	S	BD	Box	*€/Stück *€/piece
8518437 37	38	37	37	6,3	4	4,5	1	21,90

8717

Überfallscharnier, abschließbar / A4-AISI 316

Lockable swivel hasp / Fermeture sauterelle

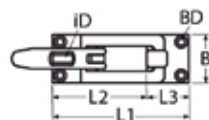

Artikel-Nr. Item-no.	L1	L2	L3	B	iD	S	BD	Box	*€/Stück *€/piece
8717480 28	75	50	25	30	6,3	4	3,8	1	14,90

Scharniere, Griffe, Haken und Ringe

Hinges, handles, hooks and rings
Charnières, poignées, crochets et anneaux

6

Überfallscharnier, abschließbar / A4-AISI 316

Lockable swivel hasp / Fermeture sauterelle

8519

Artikel-Nr. Item-no.	L1	L2	B	H	iD	S	BD	Box	*€/Stück *€/piece
8519437 37	38	28	39	37	6,3	4	5,3	1	19,70

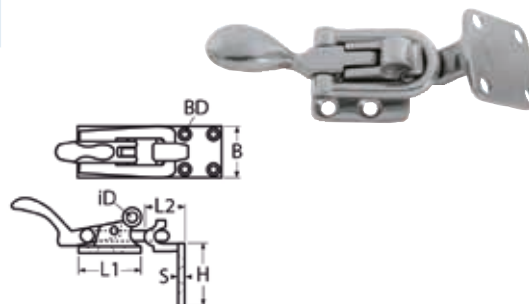

Überfallscharnier, abschließbar / A4-AISI 316

Lockable swivel hasp / Fermeture sauterelle

8854

Artikel-Nr. Item-no.	L1	L2	B	H	iD	S	BD	Box	*€/Stück *€/piece
8854480 28	85	36	28	23	6	3	4,1	1	13,50

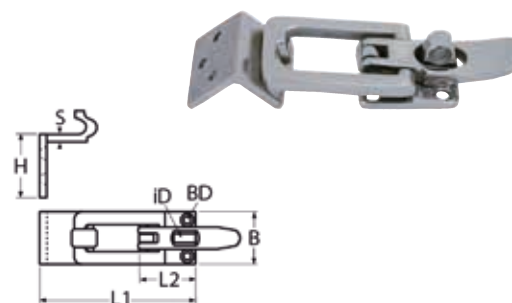

NEW

Überfallscharnier, abschließbar / A4-AISI 316

Lockable swivel hasp / Fermeture à cadenas

815173

Artikel-Nr. Item-no.	L	B	Box	*€/Stück *€/piece
815173470	70	28	2	17,80

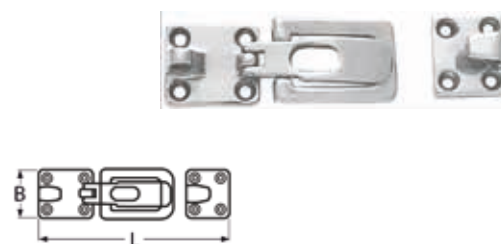

Hebelverschluss, abschließbar / A4-AISI 316

Lockable tensor latch / Fermeture à sauterelle, verrouillable

8427

Artikel-Nr. Item-no.	L	L1	L2	B1	iD	GW	Box	*€/Stück *€/piece
84274065 75	75	65	20	26	9,5	M5	1	14,90
84274085 95	90	80	21	26	9,5	M5	1	12,80
84274115 125	125	115	29	30	9,5	M6	1	17,20
84274165 185	185	165	30	30	9,5	M8	1	29,70

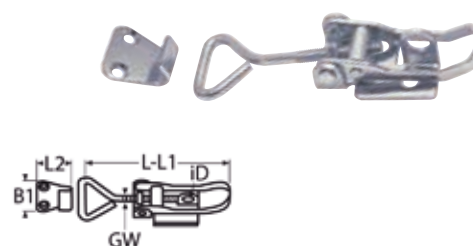

6

Scharniere, Griffe, Haken und Ringe

Hinges, handles, hooks and rings

Charnières, poignées, crochets et anneaux

815174

Hebelverschluss, verstellbar, abschließbar / A4-AISI 316

Adjustable, lockable tensor latch / Fermeture à sauterelle, ajustable, verrouillable

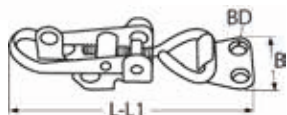

Artikel-Nr. Item-no.	L	L1	B	BD	Box	*€/Stück *€/piece
815174485 95	95	85	26	5,5	2	6,60

814666

Überfallscharnier / A4-AISI 316

Swivel hasp / Fermeture sauterelle



8146664105DB



8146664105GB



Artikel-Nr. Item-no.	Ausführung Type	L	B	H	BD	Box	*€/Stück *€/piece
8146664105		82	25	15	4,5	1	48,60
NEW 8146664105DB	Schwarz matt Dull black	82	25	15	4,5	1	86,50
NEW 8146664105GB	Schwarz glanz Glossy black	82	25	15	4,5	1	77,00

Wir empfehlen Holz-Senkschrauben DIN 7997 4,0mm, Senk-Blechschauben DIN 7982 4,2mm oder Senkschrauben DIN 965 M4.

We recommend countersunk head wood screws DIN 7997 4.0mm, countersunk tapping screws DIN 7982 4.2mm or countersunk screws DIN 965 M4.

Nous recommandons des vis à bois à tête fraisée DIN 7997 4,0mm, vis à tôle fraisée DIN 7982 4,2mm ou vis à tête fraisée DIN 965 M4.

815191

Überfallscharnier, abschließbar / A4-AISI 316

Lockable swivel hasp / Fermeture sauterelle

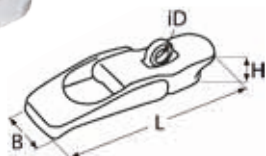

Artikel-Nr. Item-no.	L	B	H	iD	Box	*€/Stück *€/piece
8151914083	83	25	21	7	1	52,00
8151914106	106	32	29	7	1	71,00

814667

Überfallscharnier mit Schloss / A4-AISI 316

Swivel hasp with lock / Fermeture sauterelle avec serrure

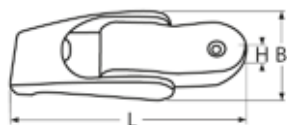

Artikel-Nr. Item-no.	L	B	H	BD	Box	*€/Stück *€/piece
8146674105	82	25	15	4,5	1	53,60
814058SCHLUESSEL	Ersatzschlüssel / Replacement key				1	8,50

Scharniere, Griffe, Haken und Ringe

Hinges, handles, hooks and rings
Charnières, poignées, crochets et anneaux

6



Spannverschluss / A4-AISI 316
Tensor latch / Fermeture à sauterelle

814912

Artikel-Nr. Item-no.	Ausführung Type	L	L1	B	D	BD	Box	*€/Stück *€/piece
814912494	Ohne Schloss Without lock	94	57	29	19	5	1	45,30
814912494S	Mit Schloss With lock	94	57	29	19	5	1	63,70
814058SCHLUESSEL	Ersatzschlüssel / Replacement key						1	8,50

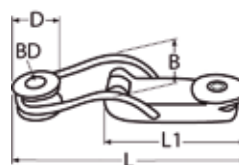

Spannverschluss, abschließbar / A2-AISI 304
Lockable tensor latch / Fermeture à sauterelle, verrouillable

8862

Artikel-Nr. Item-no.	L	L1	L2	B	iD	BD	Box	*€/Stück *€/piece
8862270	90	72	24	36	6,5	3,6	1	10,30

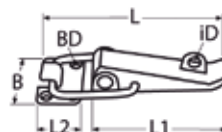

Spannverschluss / A2-AISI 304
Tensor latch / Fermeture à sauterelle

814789

Artikel-Nr. Item-no.	L	L1	L2	B1	BD	Box	*€/Stück *€/piece
8147892048	76,5	36	28	13	3,3	1	5,40

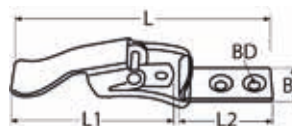

Spannverschluss / A2-AISI 304
Tensor latch / Fermeture à sauterelle

814790

Artikel-Nr. Item-no.	L	L1	L2	B1	A	H	BD	Box	*€/Stück *€/piece
8147902047	55	39	15	22	14	12	3,2	1	5,40

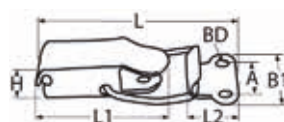

6

Scharniere, Griffe, Haken und Ringe

Hinges, handles, hooks and rings

Charnières, poignées, crochets et anneaux

814791

Spannverschluss / A2-AISI 304

Tensor latch / Fermeture à sauterelle

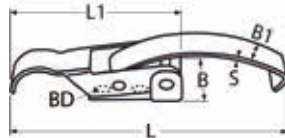

Artikel-Nr. Item-no.	L	L1	B	B1	S	BD	Box	*€/Stück *€/piece
8147912089	90	55	17	10	1,5	5	1	6,40

814792

Spannverschluss / A2-AISI 304

Tensor latch / Fermeture à sauterelle

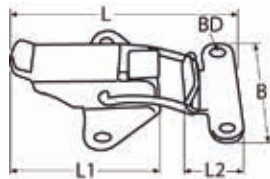

Artikel-Nr. Item-no.	L	L1	L2	B	BD	Box	*€/Stück *€/piece
8147922046	52	35	14	36	3,4	1	5,60

814793

Spannverschluss / A2-AISI 304

Tensor latch / Fermeture à sauterelle

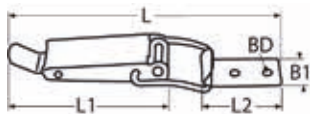

Artikel-Nr. Item-no.	L	L1	L2	B1	BD	Box	*€/Stück *€/piece
8147932077	102	59	30	14	5,2	1	6,40

814794

Spannverschluss / A2-AISI 304

Tensor latch / Fermeture à sauterelle

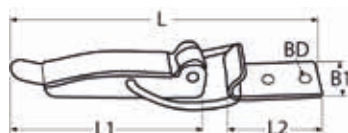

Artikel-Nr. Item-no.	L	L1	L2	B1	BD	Box	*€/Stück *€/piece
8147942087	115	73	36	19	4,3	1	6,40

Scharniere, Griffe, Haken und Ringe

Hinges, handles, hooks and rings
Charnières, poignées, crochets et anneaux

6

Spannverschluss / A2-AISI 304
Tensor latch / Fermeture à sauterelle

814795

Artikel-Nr. Item-no.	L	L1	L2	B1	BD	Box	*€/Stück *€/piece
8147952138	194	114	66	27	5,3	2	9,60

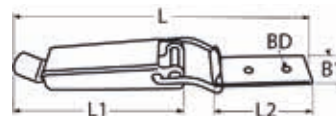

Spannverschluss, abschließbar / A2-AISI 304
Lockable tensor latch / Fermeture à sauterelle, verrouillable

814813

Artikel-Nr. Item-no.	L	L1	L2	B1	iD	BD	Box	*€/Stück *€/piece
8148132138	194	114	67	27	11	5,3	1	12,90

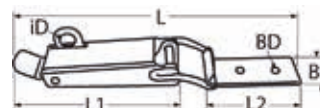

NEW

Spannverschluss, abschließbar / A2-AISI 304
Lockable tensor latch / Fermeture à sauterelle, verrouillable

815169

Artikel-Nr. Item-no.	L	B	BD	Box	*€/Stück *€/piece
8151692102	102	16,5	3,5	2	3,30

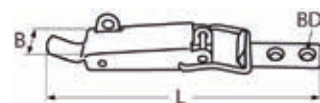

NEW

Spannverschluss, abschließbar / A2-AISI 304
Lockable tensor latch / Fermeture à sauterelle, verrouillable

815170

Artikel-Nr. Item-no.	L	B	BD	Box	*€/Stück *€/piece
815170260	60	16	4,4	2	4,00

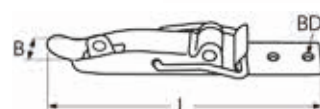

6

Scharniere, Griffe, Haken und Ringe

Hinges, handles, hooks and rings

Charnières, poignées, crochets et anneaux

815166

Spannverschluss / A2-AISI 304
Tensor latch / Fermeture à sauterelle

NEW



Artikel-Nr. Item-no.	L	L1	L2	L3	B	H	BD	Box	*€/Stück *€/piece
815166270	70	100	112	15	25	18	4,3	2	3,60

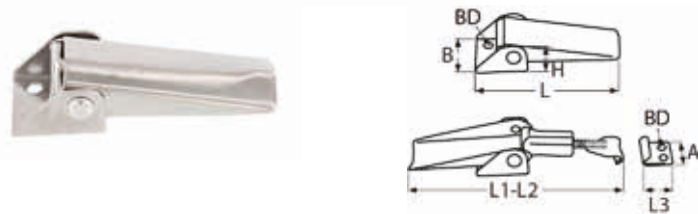

815167

Spannverschluss, verstellbar / A2-AISI 304
Adjustable tensor latch / Fermeture à sauterelle, ajustable

NEW



Artikel-Nr. Item-no.	L	L1	B	BD	Box	*€/Stück *€/piece
815167248 60	60	48	48,5	5,7	2	9,60



815168

Spannverschluss, verstellbar / A2-AISI 304
Adjustable tensor latch / Fermeture à sauterelle, ajustable

NEW



Artikel-Nr. Item-no.	L	L1	B	BD	BD1	Box	*€/Stück *€/piece
8151682138 150	55	39	24	5,4	4,4	2	5,80

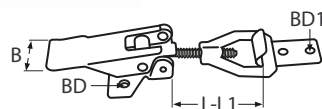

814956

Spannverschluss / A2-AISI 304
Tensor latch / Fermeture à sauterelle



Artikel-Nr. Item-no.	L	L1	L2	L3	A	BD	Box	*€/Stück *€/piece
8149562060	63	60	39	15	14,4	3	1	4,60

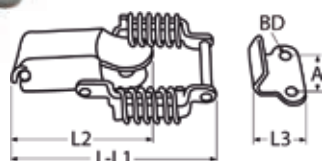

Scharniere, Griffe, Haken und Ringe

Hinges, handles, hooks and rings
Charnières, poignées, crochets et anneaux

6

Haubenthaler / A2-AISI 304
Hood latch / Support de capot

814954

Artikel-Nr. Item-no.	L	L1	L2	B	A	A1	BD	Box	*€/Stück *€/piece
814954276	76	30	44	34	16,5	17,5	4	1	24,70

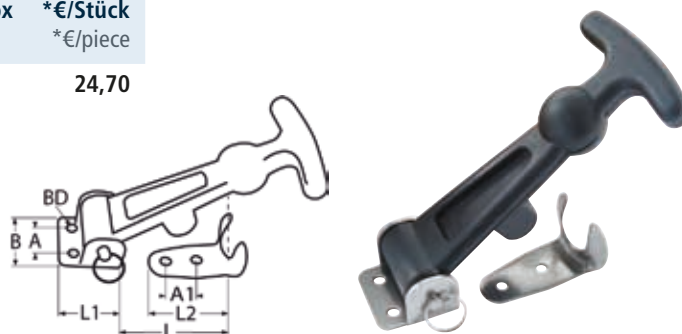

MarineTown

Einlassgriff mit Schloss / A4-AISI 316
Lifting handle with lock / Poignée avec serrure

814060

Artikel-Nr. Item-no.	D	D1	L1	H1	H2	Klemmbereich Climbing area	Box	*€/Stück *€/piece
814060461	61	50	60	10	31	4-25	1	83,58
814058SCHLUESSEL	Ersatzschlüssel / Replacement key						1	8,50

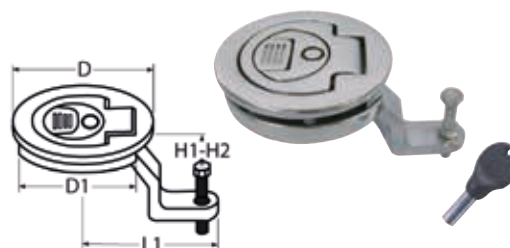

MarineTown

Einlassgriff, wasserdicht / A4-AISI 316
Waterproof lifting handle / Poignée de levage, étanche

8834

Artikel-Nr. Item-no.	L1	B1	H	D	S	Box	*€/Stück *€/piece
8834460	50	33	41	65	3	1	93,90

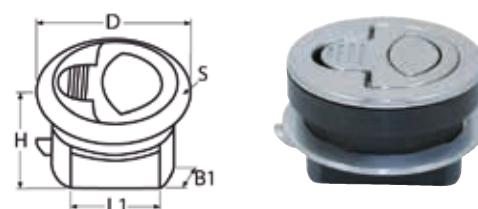

MarineTown

Einlassgriff / A4-AISI 316
Lifting handle / Poignée de levage

8648

Artikel-Nr. Item-no.	Ausführung Type	B	D	H	H1	Box	*€/Stück *€/piece
8648450RUND	Rund / Round	–	50	19	6	1	36,20
8648450ECKIG	Eckig / Square	50	–	19	6	1	38,90

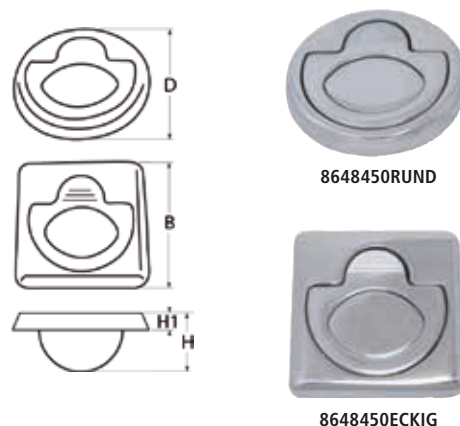

6

Scharniere, Griffe, Haken und Ringe

Hinges, handles, hooks and rings

Charnières, poignées, crochets et anneaux

814726

Einlassgriff, wasserdicht / A4-AISI 316
Lifting handle, waterproof / Poignée de levage, étanche



814726451RUND



814726451ECKIG

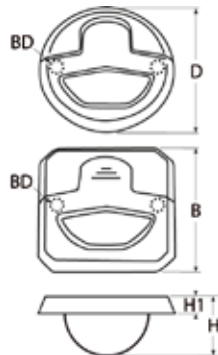

Artikel-Nr. Item-no.	Ausführung Type	B	D	H	H1	BD	Box	*€/Stück *€/piece
814726451RUND	Rund / Round	–	51	19	4,5	5	1	38,50
814726451ECKIG	Eckig / Square	51	–	19	4,5	5	1	38,50

8818

Einlassgriff mit Schloss, wasserdicht / A4-AISI 316
Lifting handle with loc, waterproof / Poignée de levage avec serrure, étanche



Artikel-Nr. Item-no.	Ausführung Type	B	D	L1	D1	H	H1	H2	K	Box	*€/Stück *€/piece
8818463 63RUND	Rund / Round	–	63	54	51	73	28	76	4	1	108,50
8818463 63RECHTECKIG	Eckig / Square	63	–	54	51	73	28	76	4	1	104,50
814058SCHLUESSEL	Ersatzschlüssel / Replacement key									1	8,50



8818463 63RUND



8818463 63RECHTECKIG

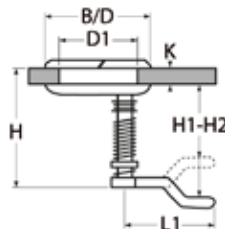

NEW

815190

Einlassgriff mit Kompression, wasserdicht / A4-AISI 316
Compression lifting handle, waterproof / Poignée de levage avec compression, étanche



Artikel-Nr. Item-no.	Ausführung Type	D	D1	L1	H	H1	H2	Box	*€/Stück *€/piece
815190478	One Schloss Without lock	78	64	39	79	49	68	1	118,20
815190478L	Mit Schloss With lock	78	64	39	79	49	68	1	138,00

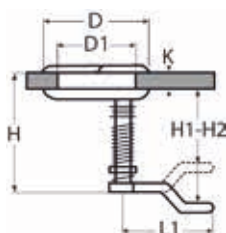

Scharniere, Griffe, Haken und Ringe

Hinges, handles, hooks and rings

Charnières, poignées, crochets et anneaux

6



Einlassgriff, wasserdicht / A4-AISI 316
Lifting handle, waterproof / Poignée de levage, étanche

814731

Artikel-Nr. Item-no.	Ausführung Type	B	D	L1	H	H1	H2	D1	K	Box	*€/Stück *€/piece
814731450R	Rund, ohne Schloss Round, without lock	–	65	54	71	25	76	51	1-20	1	106,20
814731450RS	Rund, mit Schloss Round, with lock	–	65	54	71	25	76	51	6-20	1	112,80
814731450E	Eckig, ohne Schloss Angular, without lock	65	–	54	71	25	76	51	1-20	1	104,00
814731450ES	Eckig, mit Schloss Angular, with lock	65	–	54	71	25	76	51	6-20	1	116,10
814058SCHLUESSEL	Ersatzschlüssel / Replacement key									1	8,50



814731450R



814731450RS

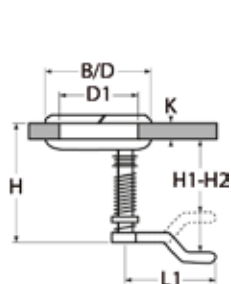

814731450E



814731450ES



Einlassgriff / A4-AISI 316
Lifting handle / Poignée de levage

814739

Artikel-Nr. Item-no.	Ausführung Type	B	D	L1	H1	H2	D1	K	Box	*€/Stück *€/piece	
814739445R	Rund, ohne Schloss Round, without lock	–	57	40	19	25	45	9-22	1	54,30	
814739445RS	Rund, mit Schloss Round, with lock	57	–	40	19	25	45	9-22	1	73,40	
814058SCHLUESSEL	Ersatzschlüssel / Replacement key									1	8,50

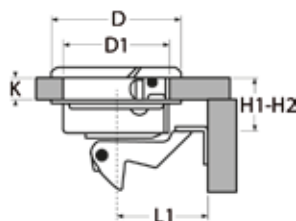

814739445R



814739445RS



Einlassgriff rund, schwarz / Plastik
Lifting handle, round, black, plastic / Poignée de levage, ronde, noir, plastique

814740

Artikel-Nr. Item-no.	D	H	H1	Box	*€/Stück *€/piece
814740351RUND	51	12,5	6	1	13,80



6

Scharniere, Griffe, Haken und Ringe

Hinges, handles, hooks and rings

Charnières, poignées, crochets et anneaux

8589

Einlassgriff mit Schloss / A2-AISI 304

Lifting handle with lock / Poignée avec serrure



Artikel-Nr. Item-no.	L	L1	B	H1	Box	*€/Stück *€/piece
8589250	50	32	55	30	1	52,10

8241

Einlassgriff eckig / A4-AISI 316

Square lifting handle / Poignée de levage, carrée

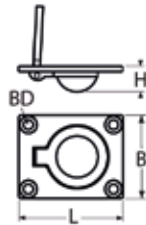

Artikel-Nr. Item-no.	L	B	H	BD	Box	*€/Stück *€/piece
8241447 38	47	38	10	4,3	1	7,50

814787

Einlassgriff rund / A4-AISI 316

Round lifting handle / Poignée de levage, ronde

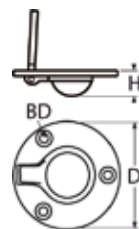

Artikel-Nr. Item-no.	D	H	BD	Box	*€/Stück *€/piece
814787450	50	10	4,3	1	8,40

8242

Einlassgriff eckig / A4-AISI 316

Square lifting handle / Poignée de levage, carrée

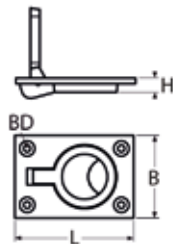

Artikel-Nr. Item-no.	L	B	H	BD	Box	*€/Stück *€/piece
8242463 44	63	44	12,5	4,3	1	9,40

Scharniere, Griffe, Haken und Ringe

Hinges, handles, hooks and rings
Charnières, poignées, crochets et anneaux

6

NEW

Einlassgriff / A4-AISI 316
Lifting handle / Poignée de levage

815186

Artikel-Nr. Item-no.	L	B	A	A1	S	BD	Box	*€/Stück *€/piece
815186465 56	65	56	52	42	1	4,5	1	8,50

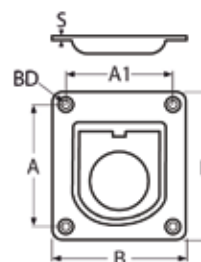

Einlassgriff rechteckig mit Schließblech / A4-AISI 316
Square lifting handle with strike plate / Anneau à cuvette avec gâchette

815003

Artikel-Nr. Item-no.	L	B	H	T	S	BD	Box	*€/Stück *€/piece
815003457 40	57	40	16	16	1,5	3,4	5	15,00

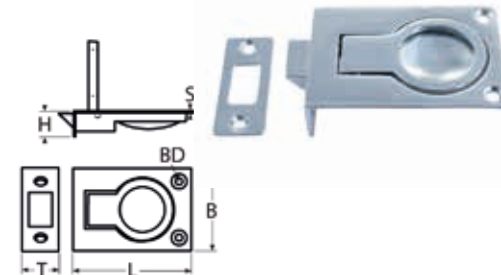

Einlassgriff / A4-AISI 316
Lifting handle / Poignée de levage

8243

Artikel-Nr. Item-no.	L	B	H	BD	Box	*€/Stück *€/piece
8243475 56	75	56	10	4,3	1	12,50

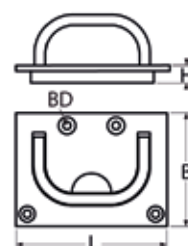

Einlassgriff / A4-AISI 316
Handle for installation / Poignée de levage

814963

Artikel-Nr. Item-no.	L	B	T	S	BD	Box	*€/Stück *€/piece
814963493 61	93	61	14	3	3,6	1	19,10

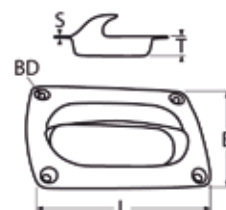

6

Scharniere, Griffe, Haken und Ringe

Hinges, handles, hooks and rings

Charnières, poignées, crochets et anneaux

814953

Einlassgriff / A2-AISI 304

Handle for installation / Poignée de levage

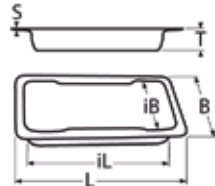

Artikel-Nr. Item-no.	L	iL	B	iB	T	S	Box	*€/Stück *€/piece
8149532080	80	69	40	29	15	1	1	16,10
8149532120	120	104	60	44	20	1	1	35,70

8527

Einlassgriff versenkt / A2-AISI 304

Lifting handle / Poignée

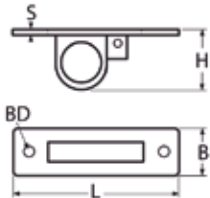

Artikel-Nr. Item-no.	L	B	H	S	BD	Box	*€/Stück *€/piece
8527290	90	25	33	3	5,3	1	11,70

815049

Schranktüren-/Schubladen-Drehverschluss / A4-AISI 316

Drawer or cabinet closure / Serrure de porte ou de tiroir



NEW

Artikel-Nr. Item-no.	L	L1	B1	T	S	Box	*€/Stück *€/piece
815049449	49	21	22	16	2,5	1	42,30

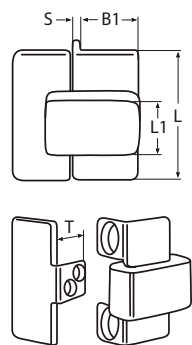

Wir empfehlen Holz-Senkschrauben DIN 7997 3,5 und 4,0mm oder Senk-Blechschraben DIN 7982 3,5 und 4,2mm.

We recommend countersunk head screws DIN 7997 3.5 and 4.0mm or countersunk tapping screws DIN 7982 3.5 and 4.2mm.

Nous recommandons des vis à bois à tête fraisée DIN 7997 3,5 et 4,0mm ou vis à tôle fraisée DIN 7982 3,5 et 4,2mm.



Scharniere, Griffe, Haken und Ringe

Hinges, handles, hooks and rings

Charnières, poignées, crochets et anneaux

6



Schieberiegel für Aufbau, federgelagert / A4-AISI 316 / Nylon

Spring loaded slide latch for on top mounting / Targette à ressort pour montage en surface

8892

Artikel-Nr. Item-no.	L1	L2	B	H	BD	Box	*€/Stück *€/piece
8892472	72	27	30	20	5	1	93,90

Wir empfehlen Senkschrauben DIN 965 M4 oder Senk-Holzschrauben DIN 7997 4,0mm.

We recommend countersunk screws DIN 965 M4 or countersunk wood screws DIN 7997 4.0mm.

Nous recommandons des vis à tête fraisée DIN 965 M4 ou vis à bois à tête fraisée DIN 7997 4,0mm.

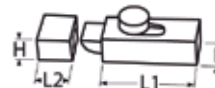

Schieberiegel mit Arretierung, schwere Ausführung / A4-AISI 316 / Plastik

Slide latch with detent position, heavy type / Fermeture targette avec verrouillage, robuste

815009

Artikel-Nr. Item-no.	Ausführung Type	L	B	L1	B1	H	A	A1	BD	Box	*€/Stück *€/piece
8150094SURF	Aufbau Latch on top	123	32	25	60	30	37	48	4	1	46,10
8150094INST	Einbau Latch inside	123	32	32	38	30	37	22	4	1	65,70

Wir empfehlen Senkschrauben DIN 965 M4 oder Senk-Holzschrauben DIN 7997 4,0mm für die Montage der Führungsbleche und DIN 965 M5 oder Senk-Holzschrauben DIN 7997 5,0mm für die Montage des Schieberiegels.

We recommend countersunk screws DIN 965 M4 or countersunk wood screws DIN 7997 4.0mm for fixing the strike or DIN 965 M5 or countersunk wood screws DIN 7997 5.0mm for fixing the latch body.

Nous recommandons des vis à tête fraisée DIN 965 M4 ou vis à bois à tête fraisée DIN 7997 4,0mm pour fixation de tôles de guidage et des vis à tête fraisée DIN 965 M5 ou vis à bois à tête fraisée DIN 7997 5,0 pour fixation de fermeture targuette.

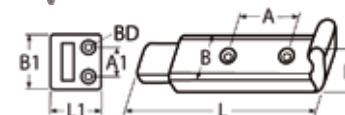
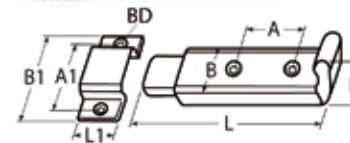

Backskistenverschluss mit Schliessblech, MT-Serie / A4-AISI 316

Lock cylinder with strike plate, MT-series / Fermeture pour coffre de bateau avec gâche, MT-séries

815070

NEW

Artikel-Nr. Item-no.	L	L1	D	B	BD	Box	*€/Stück *€/piece
815070456	56	34	19,6	50	5,5	1	25,00

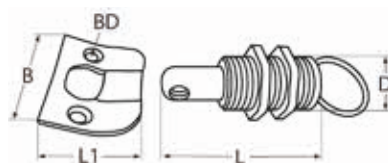

6

Scharniere, Griffe, Haken und Ringe

Hinges, handles, hooks and rings

Charnières, poignées, crochets et anneaux

814064

Schieberiegel für Einbau, federgelagert / A4-AISI 316 / Nylon
Spring loaded slide latch for inside mounting / Targette à ressort pour installation

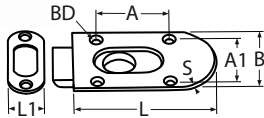

Artikel-Nr. Item-no.	L	L1	B	S	A	A1	BD	Box	*€/Stück *€/piece
814064491	91	16	56	2,5	48	45	5,5	1	61,90

Inkl. Gegenplatte und Unterlegscheibe, sowie Knopf zur Arretierung der geöffneten Tür.
Wir empfehlen Senkschrauben DIN 965 M4 oder Senk-Holzschrauben DIN 7997 4,0mm.

Inkl. strike, washer and knob for hold the door open at the wall.

We recommend countersunk screws DIN 965 M4 or countersunk wood screws DIN 7997 4.0mm.

Inkl. gâche, rondelle et bouton pour maintenir la porte ouverte au mur.

Nous recommandons des vis à tête fraisée DIN 965 M4 ou vis à bois à tête fraisée DIN 7997 4,0mm.

814691

Magnet-Schieberiegel / A4-AISI 316 / Nylon
Magnetic slide latch / Targette magnétique



8146914SURF



8146914INST

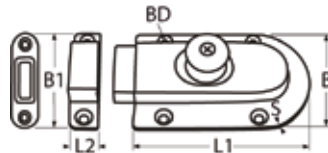

Artikel-Nr. Item-no.	L1	L2	B	B1	T	S	BD	Box	*€/Stück *€/piece
8146914SURF	91	15	56	56	16	2,5	2,5	1	90,00
8146914INST	91	21	56	70	16	2,5	5,5	1	71,80

Wir empfehlen Senkschrauben DIN 965 M4 oder Senk-Holzschrauben DIN 7997 4,0mm.

We recommend countersunk screws DIN 965 M4 or countersunk wood screws DIN 7997 4.0mm.

Nous recommandons des vis à tête fraisée DIN 965 M4 ou vis à bois à tête fraisée DIN 7997 4,0mm.

8413

Schieberiegel / A4-AISI 316
Slide latch / Targette



8413415 45



8413436 76

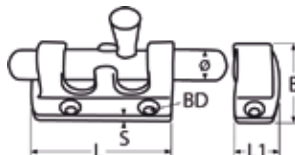

Artikel-Nr. Item-no.	L	L1	B	ø	S	BD	Box	*€/Stück *€/piece
8413415 45	45	15	30	9,5	2,5	3,4	1	13,90
8413436 76	76	36	38	9,5	3,5	3,8	1	14,20

Scharniere, Griffe, Haken und Ringe

Hinges, handles, hooks and rings

Charnières, poignées, crochets et anneaux

6

Schieberiegel / A4-AISI 316
Slide latch / Targette

815038

Artikel-Nr. Item-no.	L1	L2	B	BD	Box	*€/Stück *€/piece
815038450 30	50	30	35	4	1	12,00

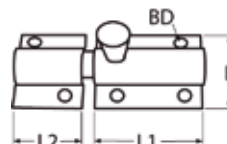

NEW

Federriegel / A2-AISI 304
Spring latch / Loquet à ressort

816006

Artikel-Nr. Item-no.	L	L1	L2	B	B1	B2	H	H1	S	BD	BD1	Box	*€/Stück *€/piece
8160062129	129	57	44	30	16	19	22	18	2	5,0	5	1	20,20
8160062150	150	72	44	40	16	19	33	23	2	6,5	5	1	30,00
8160062217	217	118	44	40	16	19	43	28	2	7,0	5	1	45,50

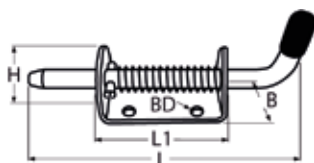
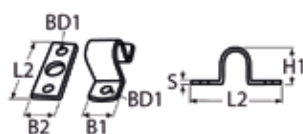

Schieberiegel mit Abdeckung, federgelagert / A4-AISI 316 / Nylon
Slide latch with cover, spring loaded / Targette à ressort avec cache

814917

Artikel-Nr. Item-no.	Ausführung Type	L1	L2	B	B1	H	A	BD	ø	Box	*€/Stück *€/piece
8149174INST	Einbau Installation	67	22	31	-	15	25	5,6	8	1	39,00
8149174SURF	Aufbau Surface	67	-	31	35	15	-	-	8	1	39,00
8149174SURFDB	Aufbau / Surface Schwarz matt Dull black	67	-	31	35	15	-	-	8	1	83,20 NEW
8149174SURFGB	Aufbau / Surface Schwarz glanz Glossy black	67	-	31	35	15	-	-	8	1	83,20 NEW



8149174INST

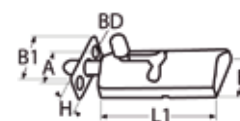

8149174SURF



8149174SURFDB
8149174SURFGB

Wir empfehlen Linsenschrauben DIN 7985 M4, Linsen-Blechschraben DIN 7981 3,9mm oder Linsen-Holzbauschrauben Art. 9045 4,0mm.

We recommend raised cheese head screws DIN 7985 M4, pan head tapping screws DIN 7981 3.9mm or pan head timber screws Art. 9045 4.0mm.

Nous recommandons des vis à tête bombée DIN 7985 M4, vis à tête TCB DIN 7981 3,9mm ou vis pour agglomérés à tête ronde Art. 9045 4,0mm

6

Scharniere, Griffe, Haken und Ringe

Hinges, handles, hooks and rings

Charnières, poignées, crochets et anneaux

815006

Schranktüren-/Schubladen-Drehverschluss / A4-AISI 316

Drawer or cabinet closure / Serrure de porte or de tiroir

 MarineTown

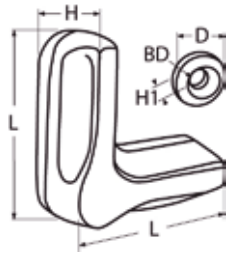

Artikel-Nr. Item-no.	L	A	H	D	H1	BD	Box	*€/Stück *€/piece
815006434	34	22	13	12	4	4,1	1	35,10

Wir empfehlen Senkschrauben DIN 965 M4 oder Senk-Holzschrauben DIN 7997 4,0mm.
We recommend countersunk screws DIN 965 M4 or countersunk wood screws DIN 7997 4.0mm.
Nous recommandons des vis à tête fraisée DIN 965 M4 ou vis à bois à tête fraisée DIN 7997 4,0mm.



815007

Schranktüren-/Schubladen-Verschluss, verdeckt / A4-AISI 316

Drawer or cabinet closure, inconspicuous / Serrure de porte or de tiroir, caché

 MarineTown

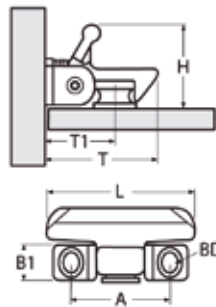

Artikel-Nr. Item-no.	L	B1	H	T	T1	A	BD	Box	*€/Stück *€/piece
815007450	50	12	24	34	21	33	4,1	1	40,00

Wir empfehlen Senkschrauben DIN 965 M4 oder Senk-Holzschrauben DIN 7997 4,0mm.
We recommend countersunk screws DIN 965 M4 or countersunk wood screws DIN 7997 4.0mm.
Nous recommandons des vis à tête fraisée DIN 965 M4 ou vis à bois à tête fraisée DIN 7997 4,0mm.

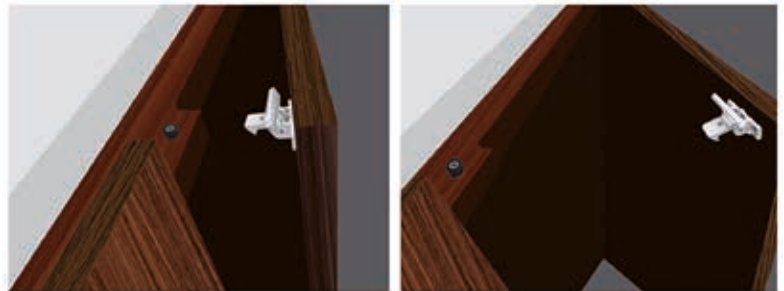

814744

Türriegel mit Feststeller / A4-AISI 316 / Plastic

Button release door latch / FERMETURE à guillotine

 MarineTown

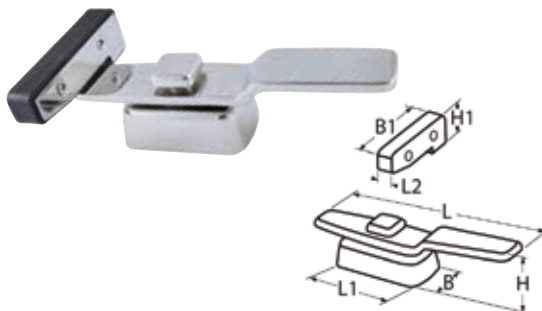

Artikel-Nr. Item-no.	L	L1	L2	B	B1	H	H1	Box	*€/Stück *€/piece
8147444166	166	73	13,5	39	71	42	24	1	115,00
8147444213	213	82	13,5	49	71	53	24	1	142,00

Scharniere, Griffe, Haken und Ringe

Hinges, handles, hooks and rings

Charnières, poignées, crochets et anneaux

6

NEW

Schranktüren-/Schubladen-Knopf / A4-AISI 316
Drawer or cabinet knob / Bouton de porte or de tiroir

815047

Artikel-Nr. Item-no.	Ausführung Type	D	D1	H	GW	BD	Box	*€/Stück *€/piece
8150474A	Poliert Polished	21	10	14	–	***4,5	10	4,90
8150474B	Poliert Polished	21	10	14	M4	–	10	6,40
8150474AGS	Geschliffen Grinded surface	21	10	14	–	***4,5	10	5,00
8150474BGS	Geschliffen Grinded surface	21	10	14	M4	–	10	6,60



8150474A



8150474B



8150474AGS



8150474BGS

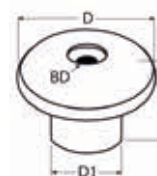

8150474A

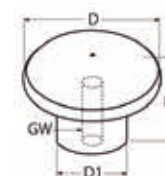

8150474B

***Wir empfehlen Senk-Holzschrauben Art. 9047 3,5mm oder Senk-Blechschraben DIN 7982 3,5mm.

***We recommend countersunk timber screws Art. 9047 3.5mm or countersunk tapping screws DIN 7982 3.5mm.

***Nous recommandons des vis pour agglomérés à tête fraisée Art. 9047 3,5mm ou vis à tôle fraisée DIN 7982 3,5mm.

Vorreiber / A4-AISI 316
Sash lock / Loqueteau pivotant

814650

Artikel-Nr. Item-no.	D	S	BD	Box	*€/Stück *€/piece
814650445	45	3,7	4,4	1	18,70

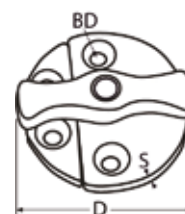

NEW

Vorreiber / A2-AISI 304
Lifting handle / Poignée de levage

815198

Artikel-Nr. Item-no.	L	B	Box	*€/Stück *€/piece
815198263	63	19	1	14,60

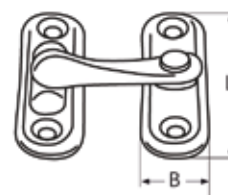

6

Scharniere, Griffe, Haken und Ringe

Hinges, handles, hooks and rings

Charnières, poignées, crochets et anneaux

8318

Sturmhaken mit Ösenschrauben / A4-AISI 316

Gate hook with srew eyes / Crochet de cabine avec piton à œil

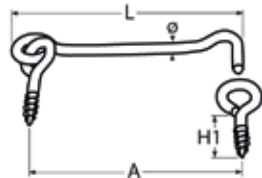

Artikel-Nr. Item-no.	L	A	H1	ø	Box	*€/Stück *€/piece
83184080	80	70	19	3,9	5	3,00
83184120	120	110	22	4,4	5	4,25

8650

Kabinenhaken / A4-AISI 316

Cabin hook / Crochet de cabine

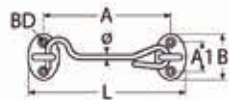

Artikel-Nr. Item-no.	L	B	A	A1	ø	BD	Box	*€/Stück *€/piece
8650450	68	33	46	20	4,4	4,5	5	20,90
8650470	93	33	71	20	4,4	4,5	5	21,60
8650490	121	33	99	20	4,4	4,5	5	23,20

8384

Kabinenhaken / A4-AISI 316

Cabin hook / Crochet de cabine

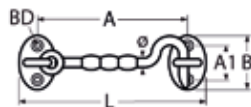

Artikel-Nr. Item-no.	L	B	A	A1	ø	BD	Box	*€/Stück *€/piece
83844100	125	37,5	100	26,5	6	3,7	1	12,00

814922

Kabinenhaken mit 2 Gegenplatten / A4-AISI 316

Cabin hook with 2 attachments / Crochet de cabine avec 2 contre-plaques

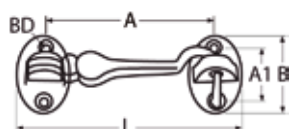

Artikel-Nr. Item-no.	L	B	A	A1	BD	Box	*€/Stück *€/piece
8149224102	102	37	77	26	3,5	1	32,10

Scharniere, Griffe, Haken und Ringe

Hinges, handles, hooks and rings
Charnières, poignées, crochets et anneaux

6

Deckenhaken mit Grundplatte / A4-AISI 316

Ceiling hook with groundplate / Crochet avec platine

814901

Artikel-Nr. Item-no.	ø	L	B	H	A	C	BD	Box	*€/Stück *€/piece
814901458	9,8	58	17	58	41	29	8,5	10	6,10

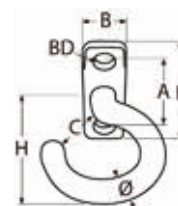

Deckenhaken / A2-AISI 304

Ceiling hook / Crochet à plafond

8348

Artikel-Nr. Item-no.	L	B	H	H1	A	S	BD	Box	*€/Stück *€/piece
83482325	33	17	33	14	20	2,5	3,4	10	3,80
83482430	43	22	48	21	30	2,5	3,4	10	5,90

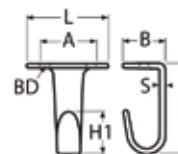

Haken / A2-AISI 304

Hook / Crochet

8347

Artikel-Nr. Item-no.	L	B	A	H	S	BD	Box	*€/Stück *€/piece
8347235	33	36	20	23	2,3	3,4	10	3,80
8347243	43	59	30	38	2,5	3,8	10	4,80

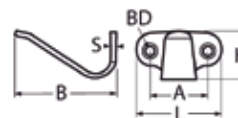

Haken mit runder Grundplatte / A2-AISI 304

Hook with round base / Crochet avec platine rond

8361

Artikel-Nr. Item-no.	L	D	H	A	S	BD	Box	*€/Stück *€/piece
8361247	47	28	37	18,5	3	3,0	10	8,40
8361265	65	35	44	22,5	4	3,8	10	8,90

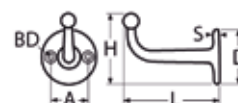

6

Scharniere, Griffe, Haken und Ringe

Hinges, handles, hooks and rings

Charnières, poignées, crochets et anneaux

8399

Kleiderhaken / A2-AISI 304

Coat hook / Crochet porte-vêtement

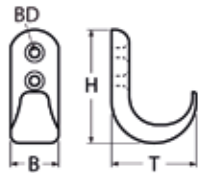

Artikel-Nr. Item-no.	B	H	T	BD	Box	*€/Stück *€/piece
8399240 30	16,5	40	30	4,3	10	3,00

8400

Kleiderhaken / A2-AISI 304

Coat hook / Crochet porte-vêtement

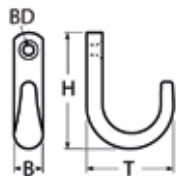

Artikel-Nr. Item-no.	B	H	T	BD	Box	*€/Stück *€/piece
8400230 25	10	40	30	3,2	10	4,50

8401

Kleiderhaken / A2-AISI 304

Coat hook / Crochet porte-vêtement

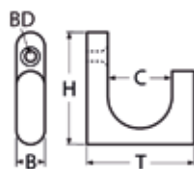

Artikel-Nr. Item-no.	B	H	T	C	BD	Box	*€/Stück *€/piece
8401235 33	9	35	33	20	3	10	6,10

814081

Kleiderhaken / A2-AISI 304

Coat hook / Crochet porte-vêtement

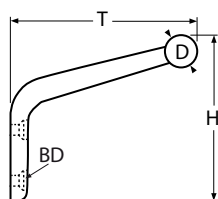

Artikel-Nr. Item-no.	H	T	D	BD	Box	*€/Stück *€/piece
814081210	35	60	10	3	10	7,50

Scharniere, Griffe, Haken und Ringe

Hinges, handles, hooks and rings
Charnières, poignées, crochets et anneaux

6

Kleiderhaken / A4-AISI 316
Coat hook / Crochet porte vêtement

814659

Artikel-Nr. Item-no.	H	H1	B	C	S	BD	Box	*€/Stück *€/piece
814659440	40	17	13	16,5	5,9	3	10	3,40

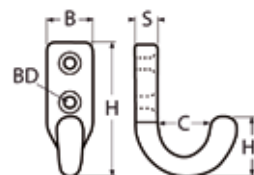

Kleiderhaken / A4-AISI 316
Coat hook / Crochet porte-vêtement

814660

Artikel-Nr. Item-no.	H	B	T	C	S	BD	Box	*€/Stück *€/piece
814660440	40	15	30	22	5,9	3,3	10	4,10

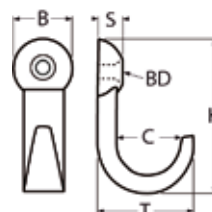

Kleiderhaken 3-fach, drehbar / A4-AISI 316
Swiveling triple coat hook / Crochet porte-vêtement triple, pivotant

814665

Artikel-Nr. Item-no.	D	D1	H	C	BD	Box	*€/Stück *€/piece
814665457	66	50	57	21	5	1	37,00

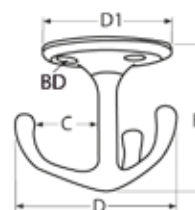

Kleiderhaken / A2-AISI 304
Coat hook / Crochet porte-vêtement

814082

Artikel-Nr. Item-no.	H	T	BD	Box	*€/Stück *€/piece
814082212	48	36	3	10	6,50

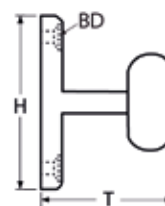

6

Scharniere, Griffe, Haken und Ringe

Hinges, handles, hooks and rings

Charnières, poignées, crochets et anneaux

814083

Kleiderhaken / A2-AISI 304

Coat hook / Crochet porte-vêtement

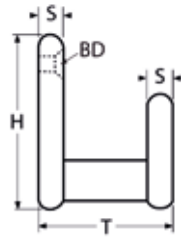

Artikel-Nr. Item-no.	H	T	S	BD	Box	*€/Stück *€/piece
814083206	38	30	6	3,2	10	6,10

814664

Kleiderhaken 3-fach schwenkbar / A4-AISI 316

Foldable tripple coat hook / Crochet porte-vêtement triple, orientable

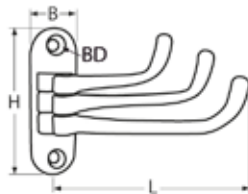
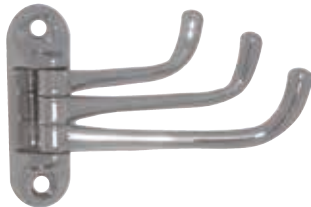

Artikel-Nr. Item-no.	L	B	H	BD	Box	*€/Stück *€/piece
814664475	106	25	75	6,3	1	55,90

8476

Kleiderhaken 2-fach, schwenkbar / A2-AISI 304

Foldable double coat hook / Crochet porte-vêtement double, orientable

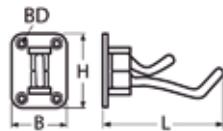

Artikel-Nr. Item-no.	L	B	H	BD	Box	*€/Stück *€/piece
8476255 38	90	43	55	3,2	5	26,90

814942

Kleiderhaken, schwenkbar, MT-Serie / A4-AISI 316

Coat hook, foldable, MT series / Crochet porte-vêtement, orientable, Série MT

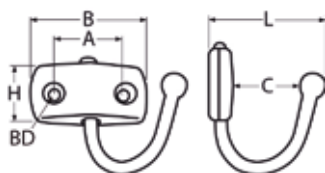

Artikel-Nr. Item-no.	L	B	H	C	A	BD	Box	*€/Stück *€/piece
814942440	45	40	20	30	25,3	4	5	5,50

Scharniere, Griffe, Haken und Ringe

Hinges, handles, hooks and rings
Charnières, poignées, crochets et anneaux

6

Kleiderhaken, klappbar / A4-AISI 316

Foldable coat hook / Crochet porte-vêtement, pliable

8830

Artikel-Nr. Item-no.	H	B	A	S	BD	Box	*€/Stück *€/piece
8830450	50	28	15,3	13	5,5	5	26,40

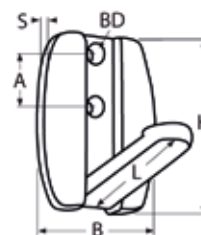

NEW

Kleiderhaken, klappbar, eckig / A4-AISI 316

Foldable square coat hook / Crochet porte-vêtement, pliable, carré

816017

Artikel-Nr. Item-no.	H	B	S	BD	Box	*€/Stück *€/piece
816017450	50	29	15	5	5	25,00

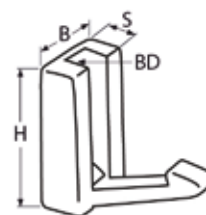

6

Kleiderhaken mit Holzgewinde / A2-AISI 304

Coat hook with wood thread / Crochet porte-vêtement avec filetage bois

814079

Artikel-Nr. Item-no.	H	T1	T2	D	ø	GW	Box	*€/Stück *€/piece
814079240	47	40	20	20	7	3	10	8,30

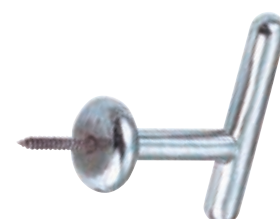
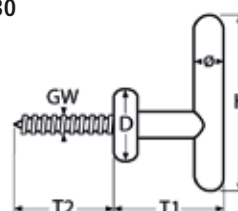

Kleiderhaken mit Holzgewinde / A2-AISI 304

Coat hook with wood thread / Crochet porte-vêtement avec filetage bois

814080

Artikel-Nr. Item-no.	T1	T2	C	D	GW	Box	*€/Stück *€/piece
814080226	41	20	26	9	3	10	5,50

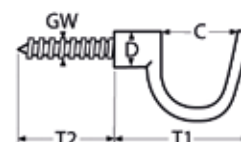

6

Scharniere, Griffe, Haken und Ringe

Hinges, handles, hooks and rings

Charnières, poignées, crochets et anneaux

814070

S-Haken, symmetrisch / A2-AISI 304 / A4-AISI 316

Symmetric S-hook / Crochet en S, symétrique



Artikel-Nr. A2 Item-no. A2	Artikel-Nr. A4 Item-no. A4	ø	iL	iD	C	Box	*€/Stück A2 *€/piece A2	*€/Stück A4 *€/piece A4
814070203	814070403	3	24	9	4	20	0,25	0,30
814070204	814070404	4	32	12	6	20	0,40	0,50
814070205	814070405	5	40	15	8	20	0,70	0,80
814070206	814070406	6	48	17	9	10	0,90	1,10
814070208	814070408	8	64	24	12	10	2,10	2,50
814070210	814070410	10	80	30	13	5	4,00	4,80

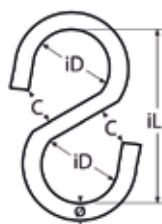

8398

S-Haken, asymmetrisch / A2-AISI 304 / A4-AISI 316

Asymmetric S-hook / Crochet en S, asymétrique



Artikel-Nr. A2 Item-no. A2	Artikel-Nr. A4 Item-no. A4	ø	iL	iD	iD1	C	C1	Box	*€/Stück A2 *€/piece A2	*€/Stück A4 *€/piece A4
839823	839843	3	30	9	16	5	10	20	0,50	0,60
839824	839844	4	36	12	19	6	12	20	0,70	0,80
839825	839845	5	43	14	21	6	12	20	0,80	1,00
839826	839846	6	50	15	25	7	15	10	0,90	1,10
839828	839848	8	67	20	33	9	20	10	1,80	2,20

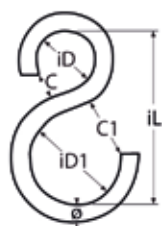

8966

S-Haken ohne Sicherung / A4-AISI 316

S-hook without safety latch / Crochet en S sans linguet de sécurité

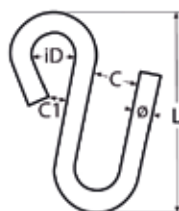

Artikel-Nr. Item-no.	ø	L	iD	C	C1	Box	*€/Stück *€/piece
8966405	5	52	9	9	2	10	1,20
8966406	6	64	10	10	5	10	1,60
8966408	8	75	16	16	5	10	3,00
8966410	10	104	20	20	8	5	5,60

Scharniere, Griffe, Haken und Ringe

Hinges, handles, hooks and rings

Charnières, poignées, crochets et anneaux

6

S-Haken mit Sicherung / A4-AISI 316

S-hook with safety latch / Crochet en S avec linguet de sécurité

8968

Artikel-Nr. Item-no.	ø	L	iD	C	C1	Box	*€/Stück *€/piece
89684095	10	100	17,0	19,5	6,9	5	5,80
89684110	11	104	16,5	22,0	7,0	5	7,70



NEW

S-Haken, Fleischerhaken / A2-AISI 304

S-hook, meat hook / Crochet en S, crochet à viande

815090

Artikel-Nr. Item-no.	ø	L	C	Box	*€/Stück *€/piece
815090240 080	4,0	80	25	20	0,90
815090250 100	5,0	100	29	20	1,40
815090250 120	5,0	120	35	20	1,40
815090255 140	5,5	140	42	10	1,90
815090260 160	6,0	160	45	10	2,30

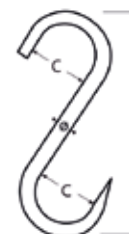

Winkel / A2-AISI 304

Corner brace / Equerre

8340

Artikel-Nr. Item-no.	L	L1	A	B	S	BD	Box	*€/Stück *€/piece
8340231 12	31	12	13	12	3	4,4	10	2,00
8340246 13	46	18	20	13	3	4,4	10	3,50
8340261 15	61	21	30	15	3	4,4	10	4,00

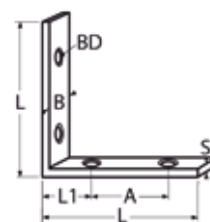

NEW

Winkel mit runden Enden, blank / A4-AISI 316

Corner brace with round ends, bare surface / Renfort d'angle avec bouts ronds, surface nue

815138

Artikel-Nr. Item-no.	L	B	S	BD	Box	*€/Stück *€/piece
8151384030 15	30	15	2	3,7	10	0,90
8151384040 15	40	15	2	3,7	10	1,30
8151384050 15	50	15	2	3,7	10	1,50
8151384060 15	60	15	2	3,7	10	1,70
8151384080 18	80	18	2	4,3	10	3,40

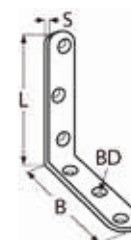

6

Scharniere, Griffe, Haken und Ringe

Hinges, handles, hooks and rings

Charnières, poignées, crochets et anneaux

8341

Winkel dreieckig / A2-AISI 304

Triangular corner brace / Équerre, triangulaire

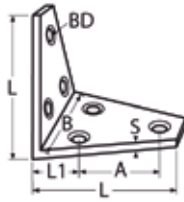

Artikel-Nr. Item-no.	L	L1	B	A	S	BD	Box	*€/Stück *€/piece
8341241 25	41	18,0	25	17	3	5	10	4,30
8341256 35	56	18,5	35	29	3	5	10	6,00
8341280 50	80	24,0	50	47	4	5	10	8,00

814085

Winkel, blank / A2-AISI 304

Corner brace, bare surface / Équerre, brossé

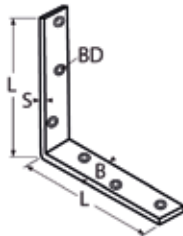

Artikel-Nr. Item-no.	L	B	S	BD	Box	*€/Stück *€/piece
8140852090	90	30	5	5	2	20,90
8140852120	120	30	5	5	2	23,00
8140852150	150	30	5	5	2	26,20
8140852200	200	30	5	5	2	38,30
8140852250	250	30	5	5	2	42,30
8140852300	300	30	5	5	2	49,80

815137

Flachwinkel, blank / A4-AISI 316

Flat corner brace, bare surface / Renfort d'angle plat, surface nue

NEW

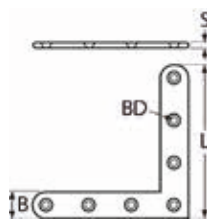

Artikel-Nr. Item-no.	L	B	S	BD	Box	*€/Stück *€/piece
8151374040 15	40	15	2	3,7	10	1,30
8151374060 15	60	15	2	3,7	10	1,70
8151374080 18	80	18	2	4,3	10	2,30
8151374100 18	100	18	2	4,3	10	3,40

815136

Flachverbinder, T-Form, blank / A4-AISI 316

Flat corner brace, T-Type, bare surface / Renfort d'angle plat, type T, surface nue

NEW

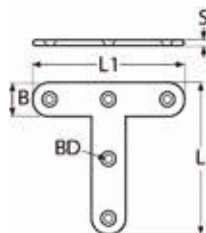

Artikel-Nr. Item-no.	L	L1	B	S	BD	Box	*€/Stück *€/piece
8151364060 15	60	45	15	2	3,7	10	1,80
8151364080 18	80	62	18	2	4,3	10	2,40
8151364100 18	100	82	18	2	4,3	10	3,40

Scharniere, Griffe, Haken und Ringe

Hinges, handles, hooks and rings
Charnières, poignées, crochets et anneaux

6

NEW

Flachverbinder, gerade, blank / A4-AISI 316
Flat corner brace, straight, bare surface / Renfort d'angle plat, droit, surface nue

815135

Artikel-Nr. Item-no.	L	B	S	BD	Box	*€/Stück *€/piece
8151354060 15	60	15	2	3,7	10	1,10
8151354080 18	80	18	2	4,3	10	1,40
8151354100 18	100	18	2	4,3	10	1,70

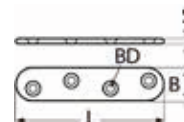

Haken / A2-AISI 304
Hook / Crochet

814966

Artikel-Nr. Item-no.	L	B	C	A	S	BD	Box	*€/Stück *€/piece
8149662185	185	18,6	109	54,5	2,5	6,5	5	9,10

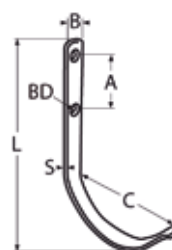

Haken, MT-Serie / A4-AISI 316
Hook / Crochet, Série MT

814943

Artikel-Nr. Item-no.	L	B	C	A	S	BD	Box	*€/Stück *€/piece
8149434110	110	15	72	25	4	6,5	5	7,40

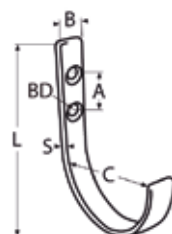

Tauwerkhälter, MT-Serie / A4-AISI 316
Rope holder, MT series / Support de cordage, Série MT

814944

Artikel-Nr. Item-no.	Ausführung Type	GW	Für Rohr-Ø For tube-Ø	BD	Box	*€/Stück *€/piece
8149444180	Haken 180mm Hook 180mm Crochet 180mm	M8	-	-	1	7,00
8149444R	Rohrhalter Tube mounting Support sur tube	M8	20/22/25	-	1	37,00
8149444W	Wandhalter Wall mounting Support sur mural	M8	-	5,3	1	20,80



8149444180



8149444R



8149444W

6

Scharniere, Griffe, Haken und Ringe

Hinges, handles, hooks and rings

Charnières, poignées, crochets et anneaux

8584

Bootshakenhalter mit langer Lasche / A2-AISI 304

Boat hook holder with long hook / Support de gaffe

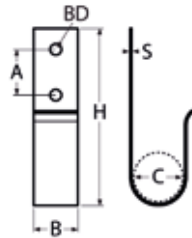

Artikel-Nr. Item-no.	H	B	C	A	S	BD	Box	*€/Stück *€/piece
85842100	100	25	32	25	1	6,3	10	3,70

8593

Bootshakenklemme / A2-AISI 304

Boat hook clip / Pince support de gaffe

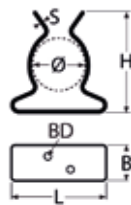

Artikel-Nr. Item-no.	Für Rohr-Ø For tube-Ø	L	B	H	S	BD	Box	*€/Stück *€/piece
8593235	16-25	35	19	38	1,2	4,0	10	3,00
8593250	28-38	50	19	54	1,2	4,0	10	3,80

8229

Ring, rund / A4-AISI 316

Ring, round / Anneau rond

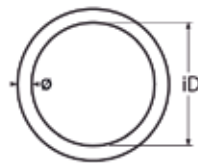

Artikel-Nr. Item-no.	ø	iD	Box	*€/Stück *€/piece
8229403 15	3	15	50	0,45
8229403 20	3	20	50	0,50
8229403 25	3	25	50	0,55
8229403 30	3	30	50	0,55
8229404 25	4	25	50	0,65
8229404 30	4	30	50	0,70
8229404 35	4	35	50	0,80
8229404 40	4	40	50	0,90
8229405 30	5	30	20	0,95
8229405 40	5	40	20	1,05
8229405 50	5	50	20	1,20
8229406 35	6	35	20	1,40
8229406 40	6	40	20	1,50
8229406 45	6	45	20	1,55
NEW 8229406 60	6	60	20	1,65
8229408 40	8	40	10	2,45
8229408 50	8	50	10	3,20
8229408 60	8	60	10	3,50
8229408 70	8	70	10	3,80
8229408 80	8	80	10	4,00
8229410 50	10	50	10	5,20
8229410 60	10	60	10	5,30
8229412 70	12	70	5	8,85
8229413 100	13	100	5	14,75

Scharniere, Griffe, Haken und Ringe

Hinges, handles, hooks and rings
Charnières, poignées, crochets et anneaux

6

D-Ring / A4-AISI 316
D-ring / Anneau en D

8274

Artikel-Nr. Item-no.	ø	iL	iB	Box	*€/Stück *€/piece
8274403 15	3	15	15	10	0,60
8274403 20	3	20	18	10	0,65
8274404 20	4	20	18	10	0,85
8274404 25	4	25	23	10	0,90
8274404 30	4	30	27	10	1,00
8274405 25	5	25	23	10	1,10
8274405 30	5	30	26	10	1,25
8274406 30	6	30	27	10	1,60
8274406 40	6	40	36	10	2,00
8274406 50	6	50	47	10	2,30
8274408 40	8	40	37	5	3,20
8274408 50	8	50	46	5	3,70
8274408 50 36	8	50	36	5	3,70
8274410 40	10	40	46	5	4,00

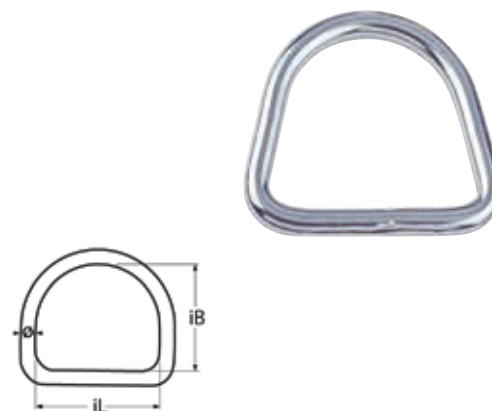

D-Ring mit Kausche, Segelecke / A4-AISI 316
D-ring with thimble, Sail corner / Anneau en D à œil, Coin voile

815012

Artikel-Nr. Item-no.	ø	DS-Ø WR-Ø	L	iL	B	iD	T	Box	*€/Stück *€/piece
815012406	6	6	62	50	55	35	15,5	5	8,00
815012408	8	8	66	50	57	34	19,0	5	9,00
815012410	10	10	85	65	74	47	23,0	5	10,50

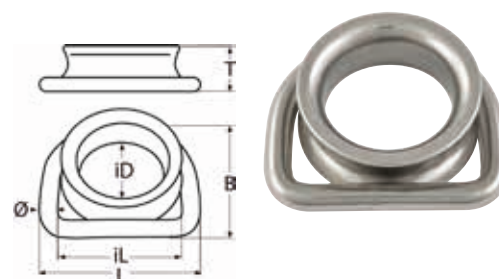

NEW

Vierkantring / A4-AISI 316
Square ring / Anneau carré

815152

Artikel-Nr. Item-no.	ø	iL	iB	Box	*€/Stück *€/piece
815152404 25	4	14	25	20	1,10
815152405 20	5	11	20	20	1,40
815152405 30	5	17	30	20	1,70
815152406 50	6	25	50	10	2,90
815152408 65	8	37	65	10	6,30

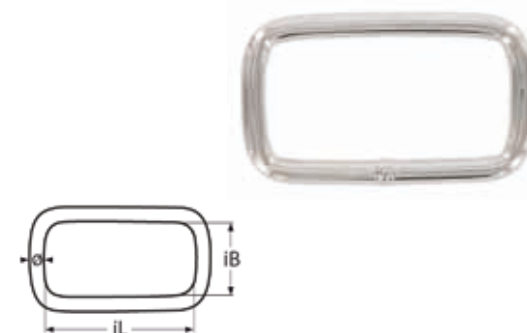

6

Scharniere, Griffe, Haken und Ringe

Hinges, handles, hooks and rings

Charnières, poignées, crochets et anneaux

8349

Triangel-Ring / A2-AISI 304

Triangle ring / Anneau triangle

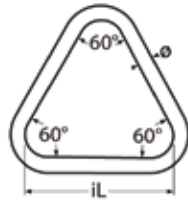

Artikel-Nr. Item-no.	ø	iL	Box	*€/Stück *€/piece
834925 25	5	25	20	1,40
834925 30	5	30	20	1,40
834926 40	6	40	10	1,40
834926 45	6	45	10	1,60
834926 50	6	50	5	1,70
834928 45	8	45	5	2,20
834928 50	8	50	5	2,40

8963

Ring mit Steg / A4-AISI 316

Ring with bar / Anneau à barrette

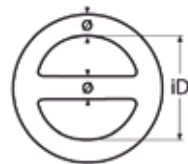

NEW

NEW

Artikel-Nr. Item-no.	ø	iD	Box	*€/Stück *€/piece
8963406030	6	30	10	2,00
8963406040	6	40	10	2,40
8963408040	8	40	10	4,10
8963408050	8	50	10	5,10
8963410060	10	60	5	9,10
8963412080	12	80	5	20,60

8975

Ring mit Doppelsteg / A4-AISI 316

Ring with double bar / Anneau à barrette double

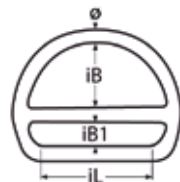

Artikel-Nr. Item-no.	ø	iL	iB	iB1	Box	*€/Stück *€/piece
8975406050	6	40	28	10	10	3,20

8965

Triangel-Ring mit Steg / A4-AISI 316

Triangle ring with bar / Anneau triangle à barrette



Artikel-Nr. Item-no.	ø	iL	iB	iB1	Box	*€/Stück *€/piece
8965405	5	53	52	5	10	3,00
8965406	6	54	53	5	10	3,20
8965408	8	56	62	5	10	5,20

Scharniere, Griffe, Haken und Ringe

Hinges, handles, hooks and rings
Charnières, poignées, crochets et anneaux

6

Ring mit Schraubverschluss, 2-tlg. / A2-AISI 304

Ring with screw lock, 2-part / Anneau avec fermeture à vis, 2 parties

8964

Artikel-Nr. Item-no.	ø	iD	Box	*€/Stück *€/piece
8964208	8	35	10	6,40

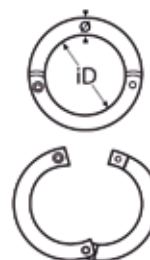

Schlüsselring / 1.4034-AISI 420 C

Key ring / Anneau brisé

8501

Artikel-Nr. Item-no.	ø	D	Box	*€/Stück *€/piece
8501220	1,4	20	100	0,20
8501230	2,0	30	100	0,50
8501240	2,5	40	100	0,80

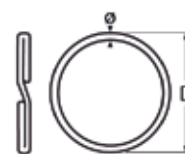

Ringnagel / A4-AISI 316

Ring nail / Anneau rond avec clou

8270

Artikel-Nr. Item-no.	ø	L1	iD	Box	*€/Stück *€/piece
827043	3	35	25	10	1,50
827044	4	35	30	10	2,10
827045	5	38	35	10	2,70
827046	6	40	40	10	3,40
827048	8	40	45	5	4,50



Kistengriff, ähnlich DIN 3136 / A2-AISI 304

Box handle according to DIN 3136 / Poignée de caisse similaire DIN 3136

8857

Artikel-Nr. Item-no.	ø	L	B	S	BD	Box	*€/Stück *€/piece
88572100 80	7,5	100	80	1,5	5,9	1	9,90

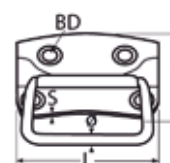

6

Scharniere, Griffe, Haken und Ringe

Hinges, handles, hooks and rings

Charnières, poignées, crochets et anneaux

8335

Griff flach / A2-AISI 304
Flat handle / Poignée plate

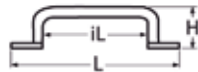

Artikel-Nr. Item-no.	L	iL	B	H	A	BD	Box	*€/Stück *€/piece
83352065	65	40	13	16	59	2,6	5	5,00
83352080	80	55	14	20	75	3,5	5	6,50
83352100	100	67	17	25	88	4,3	5	7,00

8336

Griff flach / A2-AISI 304
Flat handle / Poignée plate

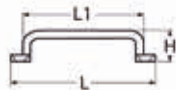
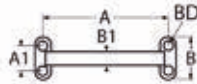

Artikel-Nr. Item-no.	L	L1	B	B1	H	A	A1	BD	Box	*€/Stück *€/piece
83362118	118	100	36	12	27	104	23	5,5	5	12,40
83362152	152	130	43	18	32	135	30	5,5	2	14,00

814078

Griff / A4-AISI 316
Handle / Poignée

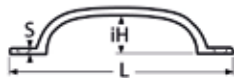

Artikel-Nr. Item-no.	L	B	iH	S	BD	Box	*€/Stück *€/piece
8140784106	150	17	27,5	3,6	6,5	5	7,50

814724

Handgriff / A4-AISI 316
Handle / Poignée

MarineTown

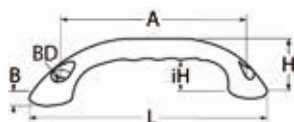

Artikel-Nr. Item-no.	L	B	H	iH	A	BD	Box	*€/Stück *€/piece
8147244124	171	25	40	32	141	7	1	60,70

Scharniere, Griffe, Haken und Ringe

Hinges, handles, hooks and rings

Charnières, poignées, crochets et anneaux

6



Handgriff mit Gewinde / A4-AISI 316

Handle with thread / Poignée avec filetage

814725

Artikel-Nr. Item-no.	L	B	H1	H2	iH	A	GW	Box	*€/Stück *€/piece
8147254124	171	25	40	37	32	142	M6	1	52,00

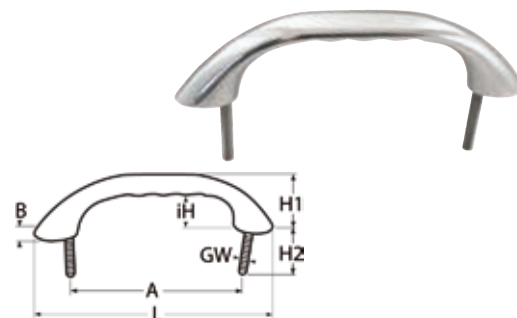

Handgriff mit Innengewinde / A2-AISI 304

Handle with internal thread / Poignée avec filetage intérieur

814680

Artikel-Nr. Item-no.	L	iL	H	D	GW	Box	*€/Stück *€/piece
8146802142	142	110	53	16	M8	5	16,80
8146802215	215	175	56	19	M8	5	20,00



Schranktüren-/Schubladen-Griff / A4-AISI 316

Drawer or cabinet handle / Poignée de porte ou de tiroir

815050

NEW

Artikel-Nr. Item-no.	Ausführung Type	L	B	H	iH	A	GW	Box	*€/Stück *€/piece
8150504152	Poliert Polished	152	20	30	24	138	M5	1	53,70
8150504152DB	Schwarz matt Dull black	152	20	30	24	138	M5	1	93,00
8150504152GB	Schwarz glanz Glossy black	152	20	30	24	138	M5	1	93,00



Handlauf mit Grundplatten / A4-AISI 316

Handrail with ground plates / Main courante

814721

Artikel-Nr. Item-no.	L1	D	H	Box	*€/Stück *€/piece
81472140200	200	22	70	1	38,80
81472140300	300	22	70	1	45,70
81472140500	500	22	70	1	44,40
81472140800	800	22	70	1	52,40
81472141000	1000	22	70	1	65,50



6

Scharniere, Griffe, Haken und Ringe

Hinges, handles, hooks and rings

Charnières, poignées, crochets et anneaux

8507

Handlauf / A4-AISI 316

Handrail / Main courante

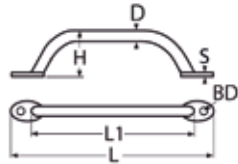

Artikel-Nr. Item-no.	L	L1	D	H	S	BD	Box	*€/Stück *€/piece
85074225	302	264	25	66	4	6,4	1	47,50
85074300	379	341	25	66	4	6,4	1	52,00
85074400	480	442	25	66	4	6,4	1	58,00
85074600	684	645	25	66	4	6,4	1	65,00

8442

Handlauf mit Außengewinde / A2-AISI 304

Handrail with external thread / Main courante avec filetage externe

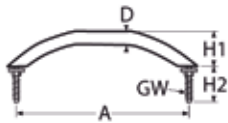

Artikel-Nr. Item-no.	A	D	H1	H2	GW	Box	*€/Stück *€/piece
84422220	220	25	57	45	5/16	1	28,60
84422300	300	25	57	45	5/16	1	31,90
84422460	460	25	57	45	5/16	1	38,00
84422610	610	25	57	45	5/16	1	50,90

Gewindeart: UNC
Thread type: UNC
Type de filetage: UNC

814189

Handlauf mit Innengewinde / A4-AISI 316

Handrail with internal thread / Main courante avec filetage interne



Artikel-Nr. Item-no.	L	B	H	H1	GW	Box	*€/Stück *€/piece
8141894300	300	33	50	13	M6	1	51,10
8141894450	450	33	50	13	M6	1	57,30
8141894610	610	33	50	13	M6	1	76,10

814190

Handlauf mit Außengewinde / A2-AISI 304

Handrail with external thread / Main courante avec filetage externe



Artikel-Nr. Item-no.	L	B	H1	H2	H3	GW	Box	*€/Stück *€/piece
8141902300	300	24	20	50	45	5/16	1	26,40
8141902460	460	24	20	50	45	5/16	1	39,60
8141902610	610	24	20	50	45	5/16	1	35,40

Gewindeart: UNC
Thread type: UNC
Type de filetage: UNC

Klampen, Blöcke und Bolzen

Cleats, blocks and bolts

Taquets, poulies et cadènes

Kapitel 7

Chapter 7



Klampen + Poller

Cleats
Taquets



Blöcke + Zubehör

Blocks + accessories
Poulies + accessories



Bolzen + Schrauben + Muttern

Pins + screws + nuts
Boulons + vis + écrous



Klampen, Blöcke und Bolzen

Cleats, blocks and bolts

Taquets, poulies et cadènes

8217

Klampe rund mit 4 Bohrungen / A4-AISI 316

Round cleat, with 4 drillings / Taquet rond avec 4 trous

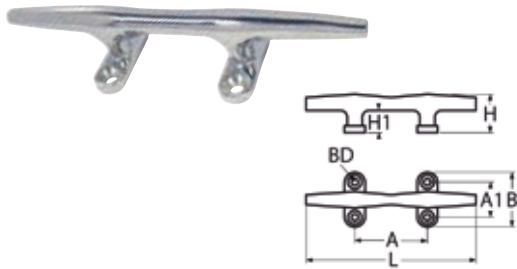

Artikel-Nr. Item-no.	L	B	H	H1	A	A1	BD	Box	*€/Stück *€/piece
82174100	100	37	26	17	50	23	5,3	1	11,70
82174125	125	40	28	18	54	25	5,3	1	11,20
82174150	150	44	30	19	56	26	6,3	1	18,50
82174200	200	52	39	25	72	34	6,3	1	29,10
82174250	250	64	48	30	90	44	8,4	1	40,30
82174300	300	71	53	34	99	50	8,4	1	52,90

8218

Klampe flach, mit 4 Bohrungen / A4-AISI 316

Flat cleat, with 4 drillings / Taquet plat avec 4 trous

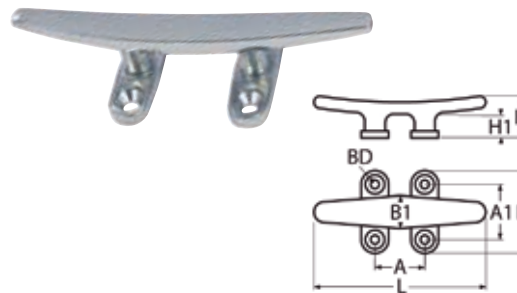

Artikel-Nr. Item-no.	L	B	B1	H	H1	A	A1	BD	Box	*€/Stück *€/piece
82184100	100	36	13	22	15	30	24	5,3	1	12,50
82184125	125	46	13	25	16	40	30	5,3	1	13,00
82184150	150	60	22	29	18	50	42	6,3	1	22,90
82184200	200	60	24	40	26	55	42	6,3	1	31,60
82184250	250	65	29	41	29	60	45	8,4	1	45,40

8221

Klampe flach, mit 2 Bohrungen / A4-AISI 316

Flat cleat, with 2 drillings / Taquet avec 2 trous

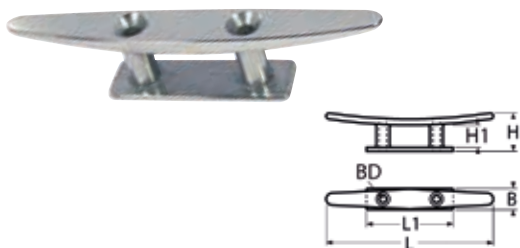

Artikel-Nr. Item-no.	L	L1	B	H	H1	BD	Box	*€/Stück *€/piece
82214100	100	55	14	23,5	15	4,3	1	12,70
82214125	125	64	16	30,0	16	4,3	1	17,30
82214150	150	73	19	32,0	19	5,3	1	22,50
82214200	200	90	22	42,0	22	6,3	1	34,30
82214250	250	110	25	52,0	25	8,4	1	48,80

814925

Klampe mit Buckel und 2 Bohrungen / A4-AISI 316

Humpback cleat with 2 drillings / Taquet avec bosse et 2 trous

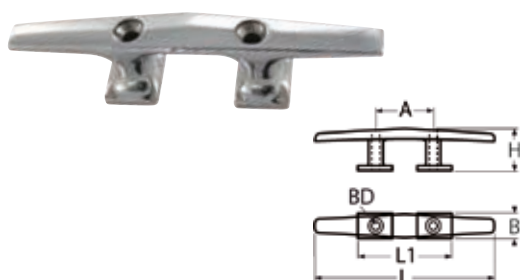

Artikel-Nr. Item-no.	L	L1	B	H	A	BD	Box	*€/Stück *€/piece
8149254160	160	81	29	35	53	6,5	1	29,60

Klappen, Blöcke und Bolzen

Cleats, blocks and bolts
Taquets, poulies et cadènes

7

Klampe mit Innengewinde / A4-AISI 316

Cleat with internal thread / Taquet avec filetage intérieur

8680

Artikel-Nr. Item-no.	Ausführung Type	L	L1	B	B1	H	A	S	GW	Box	*€/Stück *€/piece
86804150 30		150	90	30	19	45	47,4	5	M8	1	37,00
86804150 30B	schwarz/black	150	90	30	19	45	47,4	5	M8	1	42,00
86804200 35		200	120	35	22	54	70,5	5	M10	1	47,00
86804200 35B	schwarz/black	200	120	35	22	54	70,5	5	M10	1	52,00
86804250 40		265	150	40	29	70	83,0	8	M12	1	64,00
86804250 40B	schwarz/black	265	150	40	29	70	83,0	8	M12	1	70,00
86804300 50		300	160	49	38	80	85,0	10	M16	1	140,00
86804300 50B	schwarz/black	300	160	49	38	80	85,0	10	M16	1	150,00

NEW

NEW

NEW

NEW



NEW

Klampe, gewölbt, versenkbar / A4-AISI 316

Curved pull up cleat / Taquet d'amarrage rétractable

815110

Artikel-Nr. Item-no.	L	B	H	H1	K	D	D1	A	S	Antrieb Drive	Box	*€/Stück *€/piece
8151104150	152	40	100	70	21	22	20	57	5	SW30	1	175,00
8151104200	203	43	113	78	27	22	20	70	5	SW30	1	280,00

Konterplatte besteht aus Aluminium 5mm. Muttern bestehen aus A2 AISI-304.
Counterplate made of Aluminium 5mm. Nuts are made of A2 AISI-304.
Contre-plaque en Aluminium 5mm. Erou en A2 AISI-304.

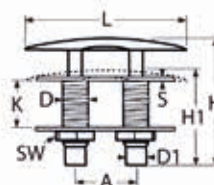

7



Klappklampe, hochglanzpoliert, MT-Serie / A4-AISI 316 / PA

Folding cleat, mirror polished, MT-series / Taquet pliable, polie miroir, MT-séries

814554

NEW

Artikel-Nr. Item-no.	L	L1	B	B1	H	A	A1	BD	Box	*€/Stück *€/piece
814554480	51	39	80	43	11	23	27	***6,4	1	25,30

***Wir empfehlen Linsensenk-Blechsrauben DIN 7983 5,5mm oder Linsensenkschrauben DIN 966 M6.
***We recommend countersunk tapping screws DIN 7983 5.5mm or countersunk screws DIN 966 M6.
***Nous recommandons des vis à tête fraisée DIN 7983 5,5mm ou vis à tête fraisée DIN 966 M6.

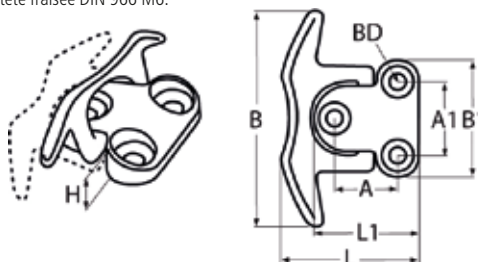

Klampen, Blöcke und Bolzen

Cleats, blocks and bolts

Taquets, poulies et cadènes

814858

Klampe mit Innengewinde und Alu-Gegenplatte / A4-AISI 316

Cleat with internal thread and alu counterplate / Taquet avec filetage int. contre-plaque en alu

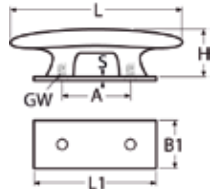

Artikel-Nr. Item-no.	L	L1	B1	H	A	S	GW	Box	*€/Stück *€/piece
8148584203	203	135	50	48	76,0	5	M10	1	150,00
8148584254	254	165	60	60	98,5	5	M12	1	240,00

Konterplatte gefertigt aus Aluminium 5mm.

Counterplate made of aluminium 5mm.

Contre-plaque en aluminium 5mm.

814859

Klampe mit Außengewinde und Alu-Gegenplatte / A4-AISI 316

Cleat with external thread and alu counterplate / Taquet avec filetage ext. contre-plaque en alu

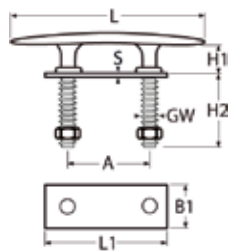

Artikel-Nr. Item-no.	L	L1	B1	H1	H2	A	S	GW	Box	*€/Stück *€/piece
8148594152	152	90	26	19	38	63	3,2	M8	1	37,00
8148594177	177	100	29	22	43	70	3,7	M8	1	55,00
8148594204	204	125	32	25	50	83	3,7	M8	1	73,00

Konterplatte gefertigt aus Aluminium 5mm.

Counterplate made of aluminium 5mm.

Contre-plaque en aluminium 5mm.

8529

Hornpoller / Knopfklampe / A4-AISI 316

Double bollard / Bitte d'amarrage taraudée

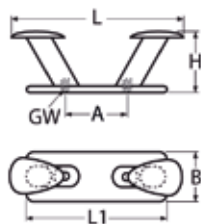

Artikel-Nr. Item-no.	L	L1	B	H	A	GW	Box	*€/Stück *€/piece
85294160	160	150	60	65	70	M10	1	75,00
85294200	200	165	65	70	100	M10	1	85,00
85294240	220	200	70	85	130	M10	1	160,00
85294300	300	255	80	100	130	M12	1	220,00
85294350	340	310	90	115	165	M18	1	280,00

814303

Klüssenklampe / A4-AISI 316

Fairlead roller / Chaumards à galets

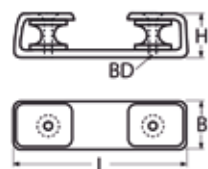

Artikel-Nr. Item-no.	L	B	H	BD	Für Tauwerk For rope	Box	*€/Stück *€/piece
8143034205 40	205	40	55	10	16-20	1	190,00
8143034260 45	260	45	75	11	24-30	1	280,00

Klappen, Blöcke und Bolzen

Cleats, blocks and bolts
Taquets, poulies et cadènes

7



Klampe, versenkbar / A4-AISI 316
Pull up cleat / Taquet coulissant

8827

Artikel-Nr. Item-no.	L	B	H	H1	K	D	D1	A	S	S1	Box	*€/Stück *€/piece
88274100	112	33	78	59	16	18	15	45	4,0	5	1	155,00
88274150	150	34	100	74	21	22	18	57	4,0	5	1	180,00
88274200	207	42	115	85	26	25	21	70	5,0	5	1	260,00
88274250	256	53	147	112	41	31	26	87	6,2	5	1	450,00

Konterplatte gefertigt aus Aluminium 5mm. Muttern aus AISI 304.
Counterplate made of Aluminium 5mm. Nuts made of AISI 304.
Contre-plaque en Aluminium 5mm. Ecrou en AISI 304.

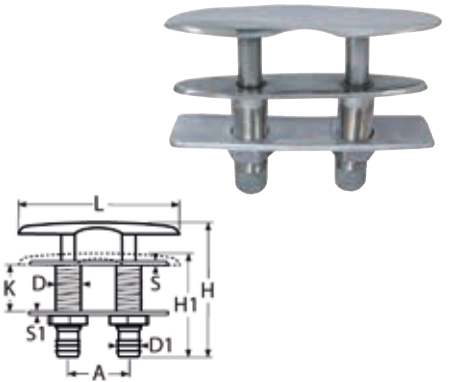

Klappklampe mit Gewinde / A4-AISI 316
Folding cleat with thread / Taquet pliable avec filetage

814640

Artikel-Nr. Item-no.	L	B	H1	H2	A	GW	Box	*€/Stück *€/piece
8146404155	155	55	14	51	43	M8	1	80,00
8146404200	200	73	15	62	57	M10	1	180,00

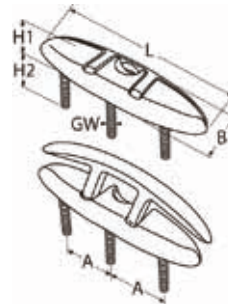

Klappklampe / A4-AISI 316
Folding cleat / Taquet pliable

814641

Artikel-Nr. Item-no.	L	B	H	A	A1	BD	Box	*€/Stück *€/piece
8146414115	115	41	10	66	33	7	1	63,00
8146414155	155	55	14	85	43	8	1	97,00
8146414200	200	73	15	114	57	10	1	170,00

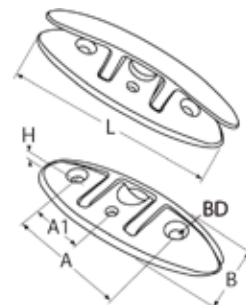

7

Klampen, Blöcke und Bolzen

Cleats, blocks and bolts

Taquets, poulies et cadènes

8508

Poller / A4-AISI 316
Bollard / Bitte d'amarrage

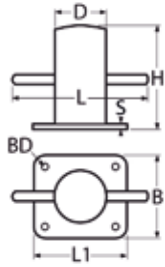

Artikel-Nr. Item-no.	L	L1	B	H	D	S	BD	Box	*€/Stück *€/piece
85084090	130	90	80	100	50	2,5	6,3	1	40,00
85084120	180	120	95	120	60	2,5	6,3	1	60,00

8557

Poller mit Konterplatte / A2-AISI 304
Bollard with counter plate / Bitte d'amarrage avec contre-plaque

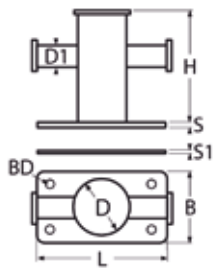

Artikel-Nr. Item-no.	L	B	H	D	D1	S	S1	BD	Box	*€/Stück *€/piece
85572200	200	110	180	76	32	6	3	13,3	1	190,00

8885

Kreuzpoller / A4-AISI 316
Cross bollard / Bitte d'amarrage en croix

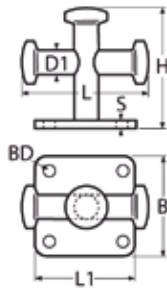

Artikel-Nr. Item-no.	L	L1	B	H	D1	S	BD	Box	*€/Stück *€/piece
8885460 60	83	60	60	85	21	7	5	1	72,00

8886

Doppel-Kreuzpoller / A4-AISI 316
Double cross bollard / Bitte d'amarrage en croix double

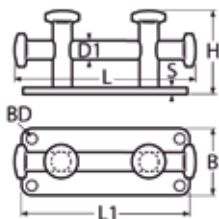

Artikel-Nr. Item-no.	L	L1	B	H	D1	S	BD	Box	*€/Stück *€/piece
88864150 60	170	150	60	85	20,7	8	5,2	1	244,00

NEW

Notklampe mit Ring / A4-AISI 316
Self-setting cleat with ring / Taquet d'urgence avec anneau

815088

Artikel-Nr. Item-no.	ø	L	B	B1	H	iD	Box	*€/Stück *€/piece
8150884135	6	135	100	60	36	75	4	16,00



Notklampe / A4-AISI 316
Self-setting cleat / Taquet d'urgencet

8517

Artikel-Nr. Item-no.	ø	L	B	H	Box	*€/Stück *€/piece
85174180 155	8	188	155	85	4	15,50



Fenderklampe, MT-Serie / A4-AISI 316
Fender cleat, MT series / Taquet, Série MT

814939

Artikel-Nr. Item-no.	L	L1	B	B1	H	BD	Box	*€/Stück *€/piece
814939455	55	40	26,5	6,5	23	3,5	2	4,50

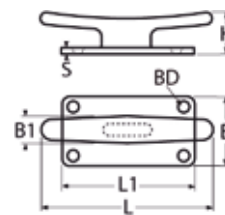

Flaggenklampe / A2-AISI 304
Flag line cleat / Taquet pour fanion

8367

Artikel-Nr. Item-no.	L	L1	B	H	A	BD	Box	*€/Stück *€/piece
8367250	50	22	10	10	8,5	3,7	10	1,80
8367280	80	38	10	19	16,8	5,0	10	3,00

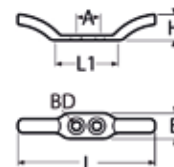

7

Klampen, Blöcke und Bolzen

Cleats, blocks and bolts

Taquets, poulies et cadènes

8973

Flaggenklampe / A4-AISI 316

Flagline cleat / Taquet pour fanion



Artikel-Nr. Item-no.	L	H	A	BD	Box	*€/Stück *€/piece
89734068	68	12	10	4,2	10	1,80
89734114	114	22	21	5,3	10	2,70
89734150	150	26	24	6,4	10	4,60

814137

Flaggenklampe, Grundplatte gewölbt / A4-AISI 316

Flag pole cleat with curved plate / Taquet pour fanion avec plaque concave

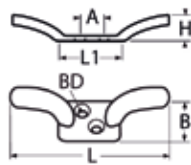

Artikel-Nr. Item-no.	L	L1	B	H	A	BD	Box	*€/Stück *€/piece
814137459	59	26	18	16	13	4,8	5	9,60

8219

Lippklampe / A4-AISI 316

Cleat with bow chocks / Chaumard croisé

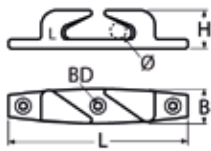

Links / Left / Gauche

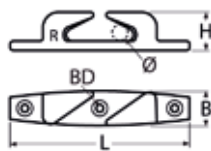

Rechts / Right / Droit

Artikel-Nr. Item-no.	L	B	H	Für Seil-Ø For rope-Ø	BD	Box	*€/Stück *€/piece
82194L115	115	23	24	10	4,3	1	15,40
82194R115	115	23	24	10	4,3	1	15,40
82194L150	150	35	29	16	5,3	1	25,50
82194R150	150	35	29	16	5,3	1	25,50

8220

Lippklampe / A4-AISI 316

Cleat with straight chocks / Chaumard droit

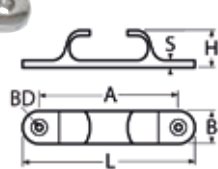

Artikel-Nr. Item-no.	L	B	H	S	A	BD	Box	*€/Stück *€/piece
82204100	100	20	24	4,5	81	5,3	2	10,90
82204125	125	20	24	4,5	105	5,3	1	14,70
82204155	155	24	36	4,5	218	5,3	1	20,00

8865

Tauklemme mit Leitöse / A4-AISI 316

Rope clamp with fairlead / Taquet coinqueur pour cordage avec filoir

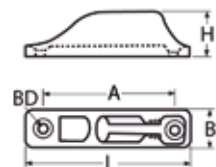

Artikel-Nr. Item-no.	L	B	H	A	Für Seil-Ø For rope-Ø	BD	Box	*€/Stück *€/piece
8865455 17	55	15	18	45,3	4 - 6	4,6	10	14,80
8865470 15	70	17	19	57,4	4 - 6	5,2	10	11,90
8865482 18	82	18	24	67,3	4 - 6	5,7	10	13,20

Klampen, Blöcke und Bolzen

Cleats, blocks and bolts
Taquets, poulies et cadènes

7

Miniblock mit Gleitlager und Bügel / A2-AISI 304 / Plastik

Miniblock with slide bearing and bow / Poulie simple avec friction et anneau

8840

Artikel-Nr. Item-no.	Für Seil-Ø For rope-Ø	Rollen-Ø Sheave-Ø	L	Box	*€/Stück *€/piece
8840225	6	25	43	1	3,20



Miniblock mit Gleitlager, Bügel und Bolzen / A4-AISI 316 / Plastik

Miniblock with slide bearing, bow and bolt / Poulie simple avec friction, anneau et axe

8391

Artikel-Nr. Item-no.	Für Seil-Ø For rope-Ø	Rollen-Ø Sheave-Ø	L	Box	*€/Stück *€/piece
8391425	6	25	59	1	3,80



Miniblock mit Gleitlager und Bolzen / A4-AISI 316 / Plastik

Miniblock with slide bearing and bolt / Poulie simple avec friction et axe

8407

Artikel-Nr. Item-no.	Für Seil-Ø For rope-Ø	Rollen-Ø Sheave-Ø	L	Box	*€/Stück *€/piece
8407425	6	25	45	1	4,00

Pin 5mm



Sprenger Nietblock mit Gleitlager / A2-AISI 304 / Plastik

Sprenger rivet block with slide bearing / Poulie à friction Sprenger

814886

Artikel-Nr. Item-no.	Für Seil-Ø For rope-Ø	Rollen-Ø Sheave-Ø	L	**BL kg	Box	*€/Stück *€/piece
8148862 01	4	16	30	190	1	8,80





Bootsbeschlage *Made in Germany – seit 1872*

Die Philosophie der Herm. Sprenger Metallwarenfabrik war schon immer, **Produkte hochster Qualitat** herzustellen. **SPRENGER** setzt ausschließlich hochwertige Materialien und Komponenten ein, um seinen Kunden zuverlassige und hochst bestandige Produkte bieten zu konnen. Alle Produkte, die mit dem **SPRENGER**-Logo gekennzeichnet sind, werden am Produktionsstandort Iserlohn im Sauerland hergestellt und stehen damit fur Qualitat „**Made in Germany**“.

*Drei verschiedene
Lager fur unter-
schiedliche
Anspruche:*



GLEITLAGER



KUGELLAGER



NADELLAGER

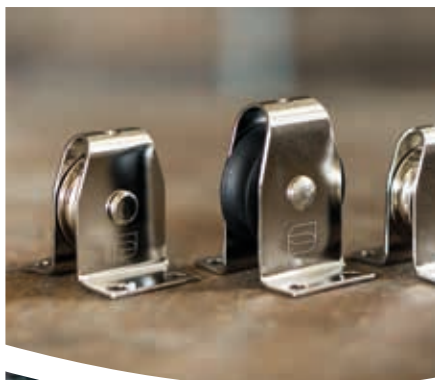



Boat fittings made in Germany – since 1872

The Herm. **SPRENGER** Metallwarenfabrik philosophy has always been to manufacture top-quality products. **SPRENGER** uses only the best materials and components in order to offer its customers reliable and exceptionally durable products. All products featuring the **SPRENGER** logo are made at the Iserlohn production plant in the Sauerland region, and so stand for 'Made in Germany' quality.

Accessoires de bateau fabriqué en Allemagne – dès 1872

La philosophie de Monsieur **SPRENGER** Metallwarenfabrik a été toujours de fabriquer des produits de toute première qualité. **SPRENGER** n'utilise que des matériaux et des composants de haute qualité afin de pouvoir proposer à ses clients des produits fiables et durables. Tous les produits portant le logo **SPRENGER** sont fabriqués sur l'atelier de fabrication d'Iserlohn dans le Sauerland - ainsi ils sont synonymes de qualité «**Made in Germany**».

Equipamiento para barcos Made in Germany – desde 1872

La filosofía de Herm. **SPRENGER** Metallwarenfabrik siempre se ha dedicado a fabricar productos de la más alta calidad. **SPRENGER** solo utiliza materiales y componentes de alta calidad para poder ofrecer a sus clientes productos confiables y altamente duraderos. Todos los productos marcados con el logotipo de **SPRENGER** se fabrican en la planta de producción de Iserlohn en Sauerland y, por lo tanto, representan la calidad „**Made in Germany**”.

Okucia eglarskie Made in Germany – od 1872

Filozofią Pana Sprengera była od zawsze produkcja najwyższej jakości produktów. **SPRENGER** wybiera jedynie najlepsze materiały do produkcji, w celu zaspokojenia wymagań klientów. Wszystkie artykuły oznaczone **SPRENGER**-Logo są wyprodukowane w miejscowości Iserlohn w Sauerland i chwalą się jakością „**Made in Germany**”.

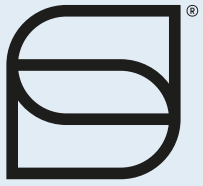

SPRENGER

Optimale Tauführung
durch gewölbte
Seitenteile

Seitenteile aus
hochwertigem,
glasfaserverstärktem
Kunststoff (UV-beständig)



Formstabile, durchgehende
Edelstahllasche für mehr
Sicherheit und Stabilität

Kennzeichnung des Lagers in
der Verstärkungslasche
(gelber Punkt = Gleitlager)

Angabe der max.
Tauerwerkstärke

Taumelvernetzung verhindert
scharfe Grate am Nietkopf

Drei Farben für unterschiedliche Ansprüche:



· stark belastbares GLEITLAGER

- Bruchlast: mind. 600 kg
- Arbeitslast: mind. 300 kg
- besonders geeignet
für stehende Lasten



· leichtlaufendes Kunststoff-KUGELLAGER

- Bruchlast: mind. 600 kg
- Arbeitslast: mind. 150 kg
- besonders geeignet für
leichtes Fieren



· leichtlaufendes NADELLAGER aus Edelstahl Rostfrei

- Bruchlast: mind. 600 kg
- Arbeitslast: mind. 300 kg
- leichtlaufend auch bei
extrem hohen Lasten

Advantages of the S-Block-Series

Avantages de série poulie S de SPRENGER

7

EN
FR



Optimized rope guidance by curved cheek parts / guide cordage optimale grâce aux parties latérales en forme courbées

Cheek of glass fibre reinforced polyamide (UV-resistant) / Parties latérales en plastique renforcé de fibre de verre de haute qualité (résistant aux UV)



Continuous strap of stainless steel for more security and stability / Languette en acier inox et forme stable et continu pour stabilité et sécurité

Identification of the bearing in the enhancing strap (yellow = sliding bearing) / Identification du roulement dans le support de renfort (point jaune = roulement)

Marking of the maximum rope Ø / Résistance maximale de cordage

Wobble riveting avoids sharp burrs on the rivet head / Le rivetage orbital empêche les crêtes sur la tête de rivet

Three colours for different demands:

Trois couleurs pour les exigences diverses:



- **heavy-duty sliding bearing**
- breaking load: min. 600 kg
- safety working load: min. 300 kg
- especially suitable for standing loads
- **palier de glissement fortement résilient**
- Charge de rupture: au moins 600 kg
- Charge de travail: au moins 300 kg
- particulièrement adapté aux charges debout



- **easily running plastic ball bearing**
- breaking load: min. 600 kg
- safety working load: min. 150 kg
- especially suitable for slightly veering
- **fonctionnement facile roulement à billes en plastique**
- Charge de rupture: au moins 600 kg
- Charge de travail: au moins 150 kg
- particulièrement adapté pour un abaissement facile



- **low-friction needle bearing – stainless steel**
- breaking load: min. 600 kg
- safety working load: min. 300 kg
- easily running even with high loads
- **roulement à aiguilles facile à utiliser**
- Charge de rupture: au moins 600 kg
- Charge de travail: au moins 300 kg
- fonctionnement régulier même avec des charges extrêmement élevées

7

814608



Klampen, Blöcke und Bolzen

Cleats, blocks and bolts
Taquets, poulies et cadènes

7



Sprenger Super Miniblock mit Gleitlager / A2-AISI 304 / Plastik
Sprenger super mini block with slide bearing / Poulie à friction Sprenger super mini

814608

	Artikel-Nr. Item-no.	Ausführung Type	Für Seil-Ø For rope-Ø	Rollen-Ø Sheave-Ø	L	**BL kg	AL kg WLL kg	Box	*€/Stück *€/piece
1	8146082-01	Drahtwirbel Wire swivel	4-10	20	55,0	150	37	5	14,10
2	8146082-02	Hundsfoth Becket	4-10	20	53,0	500	125	5	19,50
3	8146082-03	Drahtwirbel und Fenderöse Wire swivel and fender cleat	4-10	20	64,0	150	37	5	18,00
4	8146082-04	Bügel Bow	4-10	20	38,0	500	125	5	12,50
5	8146082-05	Bügel mit Bohrung Bow with hole	4-6	20	28,5	450	112	5	14,60
6	8146082-06	Bügel, 2 Rollen Bow, 2 sheaves	4-6	20	28,5	940	235	5	20,00
7	8146082-07	Bügel mit Bohrung, Rolle Messing vernickelt Bow with hole, sheave brass nickel plated	4	20	28,5	480	120	5	18,00
8	8146082-08	Gabel und Wirbel Fork and swivel	4-10	20	59,0	450	112	5	27,00

7

814609



Klampen, Blöcke und Bolzen

Cleats, blocks and bolts
Taquets, poulies et cadènes

7



Sprenger Micro XS Block mit Kugellager / A2-AISI 304 / Plastik
Sprenger micro XS block with ball bearing / Poulie Sprenger super micro XS, roulement à billes

814609

	Artikel-Nr. Item-no.	Ausführung Type	Für Seil-Ø For rope-Ø	Rollen-Ø Sheave-Ø	Rollen Sheaves	**BL kg	AL kg WLL kg	Box	*€/Stück *€/piece
1	8146092-01	Bügel Bow	max. 6	19	1	450	112	1	23,50
2	8146092-02	Wirbel Swivel	max. 6	19	1	450	112	1	44,00
3	8146092-03	Bügel und Hundsfott Bow and becket	max. 6	19	1	450	112	1	27,00
4	8146092-04	Wirbel und Hundsfott Swivel and becket	max. 6	19	1	450	112	1	50,60
5	8146092-05	Bügel Bow	max. 6	19	2	450	112	1	58,40
6	8146092-06	Bügel und Hundsfott Bow and becket	max. 6	19	2	450	112	1	69,20
7	8146092-07	Bügel Bow	max. 6	19	3	450	112	1	77,70
8	8146092-08	Bügel und Hundsfott Bow and becket	max. 6	19	3	450	112	1	97,00
9	8146092-09	Bügel und Schotklemme Bow and cam cleat	max. 6	19	3	450	112	1	165,00
10	8146092-11	Liegeblock mit Lasche Block with strap	max. 6	19	1	450	112	1	35,80
11	8146092-12	Fenderöse und Feder Fender cleat and spring	max. 6	19	1	450	112	1	37,30
12	8146092-13	Stehblock Upright block	max. 6	19	1	450	112	1	36,30

7

814610

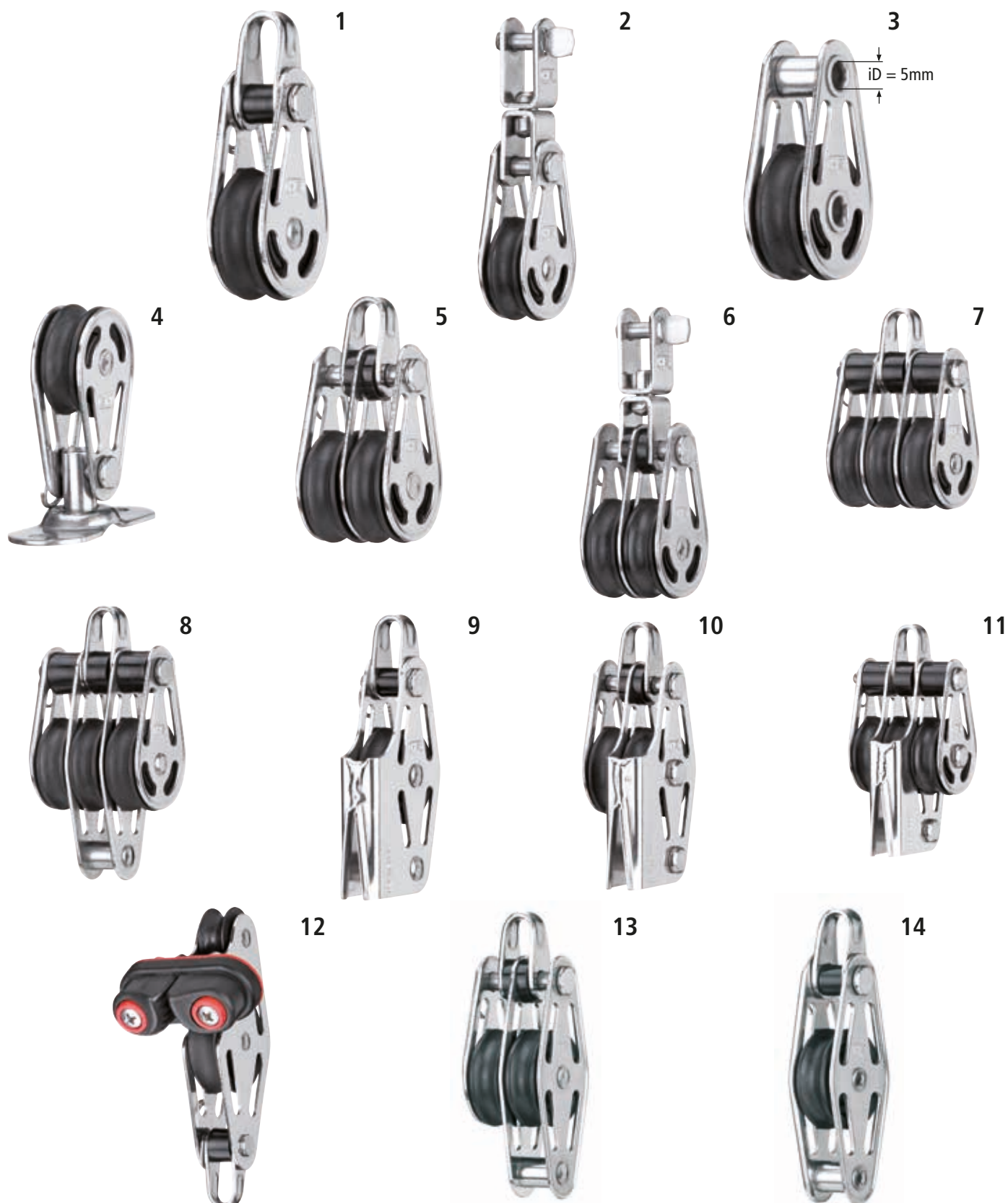

Klappen, Blöcke und Bolzen

Cleats, blocks and bolts

Taquets, poulies et cadènes

7



Sprenger Block 6mm mit Gleitlager / A2-AISI 304 / Plastik
Sprenger block 6mm with slide bearing / Poulie à friction Sprenger 6mm

814610

	Artikel-Nr. Item-no.	Ausführung Type	Für Seil-Ø For rope-Ø	Rollen-Ø Sheave-Ø	Rollen Sheaves	**BL kg	AL kg WLL kg	Box	*€/Stück *€/piece
1	8146102-01	Bügel Bow	max. 6	25	1	700	175	1	21,60
2	8146102-02	Wirbel Swivel	max. 6	25	1	700	175	1	35,80
3	8146102-03	Hohlachse Hollow axle	max. 6	25	1	700	175	1	25,10
4	8146102-04	Drehbare Grundplatte Swiveling base	max. 6	25	1	700	175	1	39,30
5	8146102-05	Bügel Bow	max. 6	25	2	700	175	1	36,10
6	8146102-06	Wirbel Swivel	max. 6	25	2	700	175	1	55,90
7	8146102-07	Bügel Bow	max. 6	25	3	700	175	1	44,90
8	8146102-08	Bügel und Hundsfott Bow and becket	max. 6	25	3	700	175	1	55,70
9	8146102-09	Niederholer Block mit V-Klemme Jamming block with V-cleat	max. 6	25	1	700	175	1	37,40
10	8146102-10	Niederholer Block mit V-Klemme Jamming block with V-cleat	max. 6	25	2	700	175	1	46,40
11	8146102-11	Niederholer Block mit V-Klemme Jamming block with V-cleat	max. 6	25	3	700	175	1	58,10
12	8146102-12	Niederholer Block mit Schotklemme Jamming block with cam cleat	max. 6	35, 22	2	900	225	1	91,50
13	8146102-13	Bügel und Hundsfott Bow and becket	max. 6	25	2	700	175	1	46,30
14	8146102-14	Bügel und Hundsfott Bow and becket	max. 6	25	1	700	175	1	30,10

7

814613



Klampen, Blöcke und Bolzen

Cleats, blocks and bolts
Taquets, poulies et cadènes

7



Sprenger Block 8mm mit Kugellager / A2-AISI 304 / Plastik
Sprenger block 8mm with ball bearing / Poulie Sprenger 8mm avec roulement à billes

814613

	Artikel-Nr. Item-no.	Ausführung Type	Für Seil-Ø For rope-Ø	Rollen-Ø Sheave-Ø	Rollen Sheaves	**BL kg	AL kg WLL kg	Box	*€/Stück *€/piece
1	8146133-01	Bügel Bow	8	27	1	600	150	1	30,30
2	8146133-02	Wirbel Swivel	8	27	1	600	150	1	39,90
3	8146133-04	Hohlachse Hollow axle	8	27	1	600	150	1	56,40
4	8146133-05	Bügel und Hundsfott Bow and becket	8	27	1	600	150	1	40,10
5	8146133-06	Wirbel und Hundsfott Swivel and becket	8	27	1	600	150	1	38,10
6	8146133-07	Bügel Bow	8	27	2	600	150	1	45,40
7	8146133-08	Bügel und Hundsfott Bow and becket	8	27	2	600	150	1	46,60
8	8146133-09	Wirbel und Hundsfott Swivel and becket	8	27	2	600	150	1	55,70
9	8146133-10	Bügel Bow	8	27	3	600	150	1	61,60
10	8146133-11	Wirbel Swivel	8	27	3	600	150	1	74,20
11	8146133-12	Bügel und Hundsfott Bow and becket	8	27	3	600	150	1	94,50
12	8146133-13	Wirbel und Schotklemme Swivel and cam cleat	8	27	3	600	150	1	90,70
13	8146133-16	Relingstützen-Block für Rohr 25mm Rail stanchion block for tube 25mm	8	27	1	600	150	1	55,70
14	8146133-17	Wirbel für 8mm Blöcke Swivel for 8mm blocks	–	–	–	600	150	1	18,10

7

814893

Sprenger S-Block 8mm mit Gleitlager / A2-AISI 304 / Plastik
 Sprenger S-block 8mm with slide bearing / Poulie à friction Sprenger poulie à S 8mm



	Artikel-Nr. Item-no.	Ausführung Type	Für Seil-Ø For rope-Ø	Rollen-Ø Sheave-Ø	Rollen Sheaves	**BL kg	AL kg WLL kg	Box	*€/Stück *€/piece
1	8148933-01	Bügel Bow	8	27	1	600	300	1	23,10
2	8148933-02	Wirbelschäkel Swivel shackle	8	27	1	600	300	1	36,90
3	8148933-03	Wirbelschäkel und Hundsfott Swivel shackle and becket	8	27	2	600	300	1	65,40
4	8148933-04	Wirbelschäkel und Hundsfott Swivel shackle and becket	8	27	2	600	300	1	67,40
5	8148933-05	Bügel Bow	8	27	1	600	300	1	34,30

1



2



3



4



5





Sprenger Block 8mm mit Gleitlager / A2-AISI 304 / Plastik

Sprenger block 8mm with slide bearing / Poulie à friction Sprenger 8mm

814611

	Artikel-Nr. Item-no.	Ausführung Type	Für Seil-Ø For rope-Ø	Rollen-Ø Sheave-Ø	Rollen Sheaves	**BL kg	AL kg WLL kg	Box	*€/Stück *€/piece
1	8146112-01	Ohne Bügel Without bow	8	30	1	800	200	1	21,60
2	8146112-02	Bügel Bow	8	30	1	800	200	1	25,60
3	8146112-03	Bügel und Hundsfott Bow and becket	8	30	1	800	200	1	35,80
4	8146112-04	Bügel und Hundsfott Bow and becket	8	30	2	800	200	1	56,60

1



2



3



4



814614

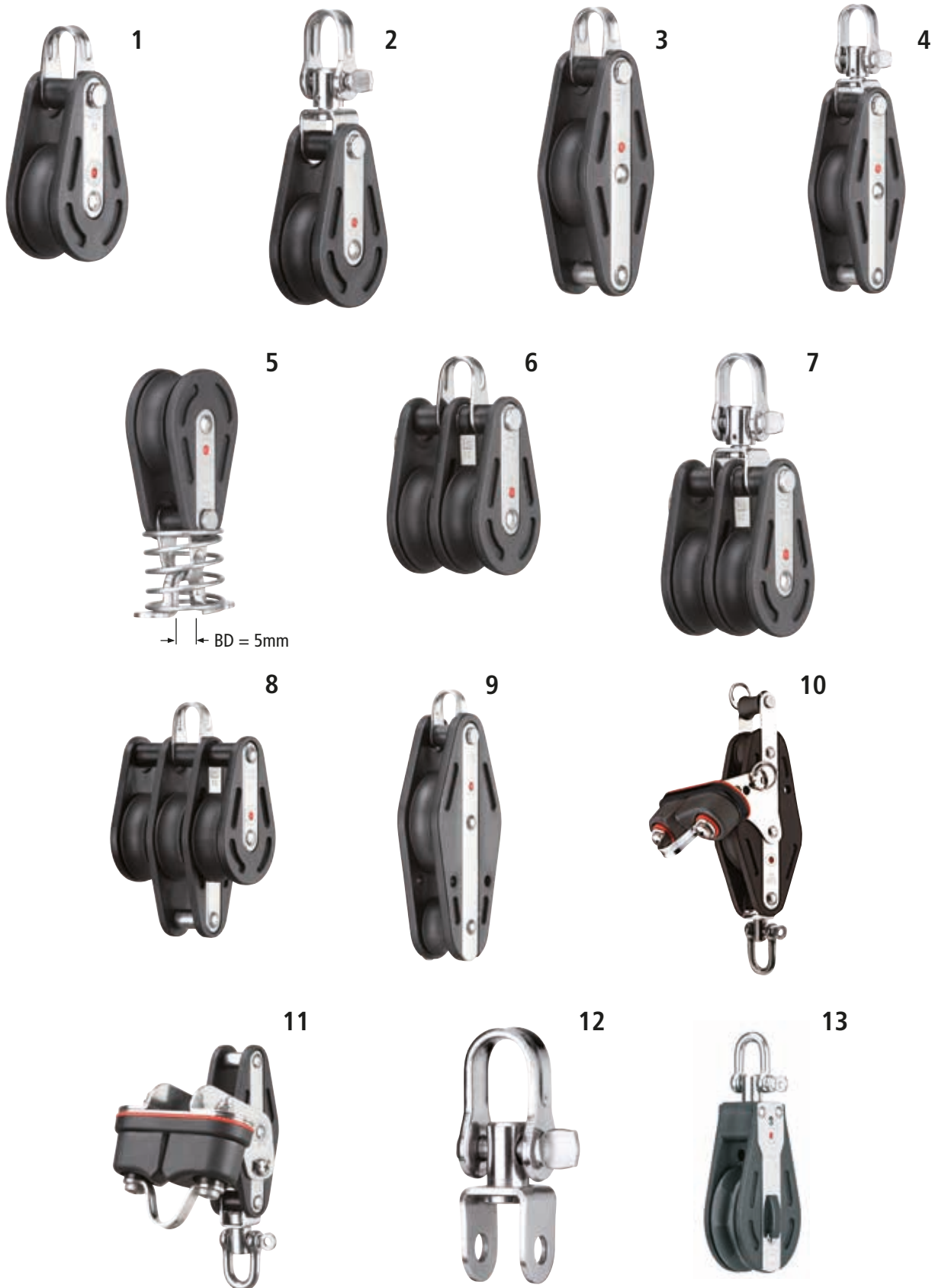

Klampen, Blöcke und Bolzen

Cleats, blocks and bolts
Taquets, poulies et cadènes

7



Sprenger Block 10mm mit Kugellager/ A2-AISI 304 / Plastik
Sprenger block 10mm with ball bearing / Poulie Sprenger 10mm avec roulement à billes

814614

	Artikel-Nr. Item-no.	Ausführung Type	Für Seil-Ø For rope-Ø	Rollen-Ø Sheave-Ø	Rollen Sheaves	**BL kg	AL kg WLL kg	Box	*€/Stück *€/piece
1	8146143-01	Bügel Bow	10	35	1	850	212	1	40,10
2	8146143-02	Wirbel Swivel	10	35	1	850	212	1	59,20
3	8146143-03	Bügel und Hundsfott Bow and becket	10	35	1	850	212	1	52,10
4	8146143-04	Wirbel und Hundsfott Swivel and becket	10	35	1	850	212	1	77,90
5	8146143-05	Mit Fenderöse und Feder With fender cleat and spring	10	35	1	850	212	1	60,80
6	8146143-06	Bügel Bow	10	35	2	850	212	1	77,00
7	8146143-07	Wirbel Swivel	10	35	2	850	212	1	99,80
8	8146143-09	Bügel und Hundsfott Bow and becket	10	35	3	850	212	1	114,50
9	8146143-11	Violinenblock mit Bügel Violin shaped block with bow	10	44 26	2	850	212	1	74,90
10	8146143-12	Violinenblock mit Schotklemme Violin shaped block with cam cleat	10	46	2	850	212	1	207,30
11	8146143-13	Grossschotblock mit Wirbel und Hundsfott Mainsheet block with swivel and becket	10	35	1	850	212	1	199,20
12	8146143-15	Wirbel für 10mm Blöcke Swivel for 10mm blocks	–	–	–	850	212	1	30,80
13	8146143-16	Rechts ratschend mit Wirbelschäkel Right ratchet with swivel shackle	6-10	35	1	900	225	1	157,80

7

814612

Sprenger Block 10mm mit Gleitlager / A2-AISI 304 / Plastik
 Sprenger block 10mm with slide bearing / Poulie à friction Sprenger 10mm



	Artikel-Nr. Item-no.	Ausführung Type	Für Seil-Ø For rope-Ø	Rollen-Ø Sheave-Ø	Rollen Sheaves	**BL kg	AL kg WLL kg	Box	*€/Stück *€/piece
1	8146122-01	Bügel Bow	10	35	1	850	212	1	28,10
2	8146122-02	Bügel und Hundsfott Bow and becket	10	35	1	850	212	1	35,80
3	8146122-03	Bügel Bow	10	35	2	850	212	1	49,10



Klappen, Blöcke und Bolzen

Cleats, blocks and bolts
Taquets, poulies et cadènes

7



Sprenger S-Block 10mm mit Gleitlager / A2-AISI 304 / Plastik
Sprenger S-block 10mm with slide bearing / Poulie à friction Sprenger poulie à S 10mm

814894

	Artikel-Nr. Item-no.	Ausführung Type	Für Seil-Ø For rope-Ø	Rollen-Ø Sheave-Ø	Rollen Sheaves	**BL kg	AL kg WLL kg	Box	*€/Stück *€/piece
1	8148943-01	Wirbelschäkel Swivel shackle	10	40	1	900	360	1	46,30
2	8148943-02	Bügel und Hundsfott Bow and becket	10	40	2	1100	440	1	77,40
3	8148943-03	Bügel Bow	10	40	2	1100	440	1	70,60
4	8148943-04	Bügel Bow	10	40	1	900	360	1	27,50
5	8148943-05	Bügel und Hundsfott Bow and becket	10	40	1	900	360	1	37,80



7

7

Klampen, Blöcke und Bolzen

Cleats, blocks and bolts

Taquets, poulies et cadènes

814615

 SPRENGER
KUGELLAGER



Klampen, Blöcke und Bolzen

Cleats, blocks and bolts

Taquets, poulies et cadènes

7



Sprenger Block 12mm mit Kugellager / A2-AISI 304 / Plastik
 Sprenger block 12mm with ball bearing / Poulie Sprenger 12mm avec roulement à billes

814615

	Artikel-Nr. Item-no.	Ausführung Type	Für Seil-Ø For rope-Ø	Rollen-Ø Sheave-Ø	Rollen Sheaves	**BL kg	AL kg WLL kg	Box	*€/Stück *€/piece
1	8146153-01	Bügel Bow	12	50	1	1000	250	1	50,60
2	8146153-02	Wirbel Swivel	12	50	1	1000	250	1	68,10
3	8146153-03	Bügel und Hundsfott Bow and becket	12	50	1	1000	250	1	61,70
4	8146153-04	Bügel Bow	12	50	2	1000	250	1	102,80
5	8146153-05	Bügel Bow	12	50	3	1000	250	1	148,90
6	8146153-06	Bügel und Hundsfott Bow and becket	12	50	2	1000	250	1	113,00
7	8146153-08	Violinenblock mit Bügel Violin shaped block with bow	12	50 / 29	2	1000	250	1	86,50
8	8146153-09	Violinenblock mit Hundsfott und Wirbel Violin shaped block with swivel and becket	12	50 / 29	2	1000	250	1	109,80
9	8146153-11	Mit Schnappschäkel With snap shackle	12	50	1	1000	250	1	111,50
10	8146153-12	Grossschotblock mit Wirbel und Hundsfott Mainsheet block with swivel and becket	12	50	1	1000	250	1	238,00
11	8146153-13	Grossschotblock mit Wirbel und Hundsfott Mainsheet block with swivel and becket	12	50	3	1000	250	1	350,10
12	8146153-14	Wirbel für 12mm Blöcke Swivel for 12mm blocks	–	–	–	1000	250	1	29,30

7

814895

Sprenger S-Block 12mm mit Gleitlager / A2-AISI 304 / Plastik
 Sprenger S-block 12mm with slide bearing / Poulie à friction Sprenger poulie à S 12mm



	Artikel-Nr. Item-no.	Ausführung Type	Für Seil-Ø For rope-Ø	Rollen-Ø Sheave-Ø	Rollen Sheaves	**BL kg	AL kg WLL kg	Box	*€/Stück *€/piece
1	8148953-01	Bügel Bow	12	57	2	1300	510	1	84,70
2	8148953-02	Bügel Bow	12	57	1	1200	460	1	37,60
3	8148953-03	Violinenblock mit Bügel und Hundsfoß Violin shaped block with bow and becket	12	57	2	1300	510	1	94,20
4	8148953-04	Violinenblock mit Bügel Violin shaped block with bow	12	57 / 29	2	1400	560	1	69,40
5	8148953-05	Wirbelschäkel Swivel shackle	12	57	1	1200	460	1	52,30
6	8148953-06	Bügel und Hundsfoß Bow and becket	12	57	1	1200	460	1	48,30
7	8148953-07	Grossschotblock mit Wirbelschäkel und Hundsfoß Mainsheetblock with swivel and becket	12	57	2	1400	560	1	185,00



Klappen, Blöcke und Bolzen

Cleats, blocks and bolts

Taquets, poulies et cadènes

7



Sprenger Block 12mm mit Gleitlager / A2-AISI 304 / Plastik

Sprenger block 12mm with slide bearing / Poulie à friction Sprenger 12mm

814896

Artikel-Nr. Item-no.	Ausführung Type	Für Seil-Ø For rope-Ø	Rollen-Ø Sheave-Ø	Rollen Sheaves	**BL kg	AL kg WLL kg	Box	*€/Stück *€/piece
8148962-01	Bügel Bow	12	40	1	900	225	1	30,80



Sprenger Stehblock mit Gleitlager / A2-AISI 304 / Plastik

Sprenger upright block with slide bearing / Poulie verticale à friction Sprenger

814616

Artikel-Nr. Item-no.	Für Seil-Ø For rope-Ø	Rollen-Ø Sheave-Ø	Rollen Sheaves	**BL kg	AL kg WLL kg	Box	*€/Stück *€/piece
8146162-01	6	30	1	1200	300	1	27,10



Sprenger Liegeblock mit Gleitlager / A2-AISI 304 / Plastik

Sprenger cheek block with slide bearing / Poulie à plaquer et à friction Sprenger

814889

Artikel-Nr. Item-no.	Für Seil-Ø For rope-Ø	Rollen-Ø Sheave-Ø	Rollen Sheaves	**BL kg	AL kg WLL kg	Box	*€/Stück *€/piece
8148892-01	8	27	1	300	75	1	24,30



Sprenger Liegeblock mit Gleitlager / A2-AISI 304 / Plastik

Sprenger cheek block with slide bearing / Poulie à plaquer et à friction Sprenger

814888

Artikel-Nr. Item-no.	Für Seil-Ø For rope-Ø	Rollen-Ø Sheave-Ø	Rollen Sheaves	Box	*€/Stück *€/piece
8148882-01	8	20	1	1	18,00

Blehschraube = DIN 7971 4,8x25mm
Plan head tapping screw = DIN 7971 4,8x25mm
Vis à tôle à tête cylindrique = DIN 7971 4,8x25mm

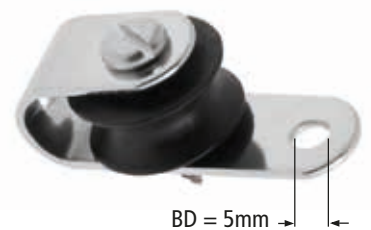

Klampen, Blöcke und Bolzen

Cleats, blocks and bolts

Taquets, poulies et cadènes

814617

Sprenger Einlassblock mit Kugellager / A2-AISI 304 / Plastik

Sprenger thru deck block with ball bearing / Poulie d'entrée Sprenger avec roulement à billes

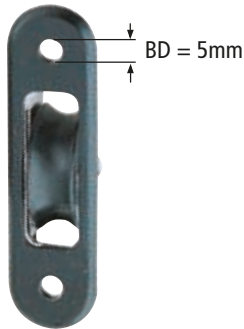

Artikel-Nr. Item-no.	Für Seil-Ø For rope-Ø	Rollen-Ø Sheave-Ø	Rollen Sheaves	A	Box	*€/Stück *€/piece
8146172-01	8	27	1	45	1	72,10

814618

Sprenger Liegeblock mit Gleitlager / A2-AISI 304 / Plastik

Sprenger cheek block with slide bearing / Poulie à plaquer et à friction Sprenger



Artikel-Nr. Item-no.	Für Seil-Ø For rope-Ø	Rollen-Ø Sheave-Ø	Rollen Sheaves	GW	A	Box	*€/Stück *€/piece
8146182-01	12	50	1	M6	40	1	52,60

814887

Sprenger Micro XS Block mit Kugellager / A2-AISI 304

Sprenger micro XS block with ball bearing / Poulie Sprenger super micro XS avec roulement à billes



Artikel-Nr. Item-no.	Ausführung Type	DS-Ø WR-Ø	Rollen-Ø Sheave-Ø	Rollen Sheaves	**BL kg	AL kg WLL kg	Box	*€/Stück *€/piece
8148872-01	Bügel Bow	max. 4	19	1	450	112	1	31,60

Blöcke für Drahtseil (Drahtseile siehe Seite 125-131)

Blocks for wire rope (wire rope see page 125-131)

Blocs pour câble (câble métallique voir page 125-131)

815035

Sprenger Micro XS Liegeblock mit Kugellager / A2-AISI 304

Sprenger micro XS cheek block with ball bearing / Poulie de renvoi Sprenger Micro XS, roulement à billes



Artikel-Nr. Item-no.	DS-Ø WR-Ø	Rollen-Ø Sheave-Ø	Rollen Sheaves	BD	**BL kg	AL kg WLL kg	Box	*€/Stück *€/piece
8150352-01	max. 4	19	1	4	450	112	1	43,30

Blöcke für Drahtseil (Drahtseile siehe Seite 125-131)

Blocks for wire rope (wire rope see page 125-131)

Blocs pour câble (câble métallique voir page 125-131)

Klampen, Blöcke und Bolzen

Cleats, blocks and bolts

Taquets, poulies et cadènes

7



Sprenger Micro XS Stehblock mit Kugellager / A2-AISI 304

Sprenger micro XS standing block with ball bearing / Poulie verticale Sprenger Micro XS avec roulement à billes

815036

Artikel-Nr. Item-no.	DS-Ø WR-Ø	Rollen-Ø Sheave-Ø	Rollen Sheaves	**BL kg	AL kg WLL kg	Box	*€/Stück *€/piece
8150362-01	max. 4	19	1	450	112	1	43,30

Blöcke für Drahtseil (Drahtseile siehe Seite 125-131)

Blocks for wire rope (wire rope see page 125-131)

Blocs pour câble (câble métallique voir page 125-131)

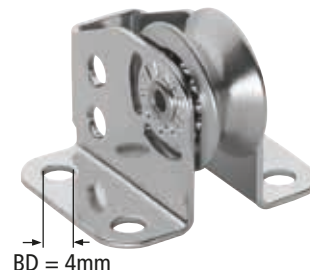

Sprenger Block mit Gleitlager / A2-AISI 304

Sprenger block with slide bearing / Poulie à friction Sprenger

814891

Artikel-Nr. Item-no.	Ausführung Type	DS-Ø WR-Ø	Rollen-Ø Sheave-Ø	Rollen Sheaves	**BL kg	AL kg WLL kg	Box	*€/Stück *€/piece
8148912-01	Bügel Bow	6	30	1	900	225	1	31,30

Blöcke für Drahtseil (Drahtseile siehe Seite 125-131)

Blocks for wire rope (wire rope see page 125-131)

Blocs pour câble (câble métallique voir page 125-131)



Sprenger Liegeblock mit Gleitlager / A2-AISI 304

Sprenger cheek block with slide bearing / Poulie à plaquer et à friction Sprenger

814890

Artikel-Nr. Item-no.	DS-Ø WR-Ø	Rollen-Ø Sheave-Ø	Rollen Sheaves	**BL kg	AL kg WLL kg	Box	*€/Stück *€/piece
8148902-02	4	25	1	900	225	1	30,20
8148902-01	6	30	1	900	225	1	30,80

Blöcke für Drahtseil (Drahtseile siehe Seite 125-131)

Blocks for wire rope (wire rope see page 125-131)

Blocs pour câble (câble métallique voir page 125-131)



Sprenger Stehblock mit Gleitlager / A2-AISI 304

Sprenger upright block with slide bearing / Poulie verticale à friction Sprenger

814885

Artikel-Nr. Item-no.	L	B	BD	DS-Ø WR-Ø	Rollen-Ø Sheave-Ø	Rollen Sheaves	**BL kg	AL kg WLL kg	Box	*€/Stück *€/piece
8148852-02	25	39	4	4	25	1	1000	250	1	25,00
8148852-01	25	39	4	6	30	1	1000	250	1	33,50

Blöcke für Drahtseil (Drahtseile siehe Seite 125-131)

Blocks for wire rope (wire rope see page 125-131)

Blocs pour câble (câble métallique voir page 125-131)

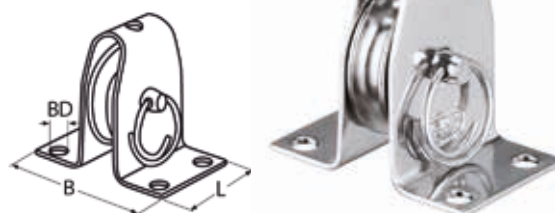

Klampen, Blöcke und Bolzen

Cleats, blocks and bolts

Taquets, poulies et cadènes

814619

Sprenger Stehblock mit Gleitlager / A2-AISI 304 / Alu / Plastik
Sprenger upright block with slide bearing / Poulie verticale à friction Sprenger

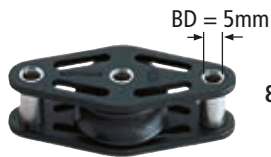

8146190-01

Artikel-Nr. Item-no.	Für Seil-Ø For rope-Ø	Rollen-Ø Sheave-Ø	Rollen Sheaves	**BL kg	AL kg WLL kg	Box	*€/Stück *€/piece
8146190-01	12	29	1	900	225	1	73,20

814620

Sprenger Seilrolle mit Kugellager / A2-AISI 304
Sprenger rope sheave with ball bearing / Réa Sprenger avec roulement à billes



8146203-25



8146203-27

Artikel-Nr. Item-no.	Für Seil-Ø For rope-Ø	DS-Ø WR-Ø	Rollen-Ø Sheave-Ø	Achse Pivot	Box	*€/Stück *€/piece
8146203-25	4-5	3	25	6	1	30,30
8146203-27	8	–	27	5	1	77,40

814621

Sprenger Seilrolle mit Kugellager / Plastik
Sprenger rope sheave with ball bearing / Réa Sprenger avec roulement à billes



Artikel-Nr. Item-no.	Für Seil-Ø For rope-Ø	Rollen-Ø Sheave-Ø	Achse Pivot	Box	*€/Stück *€/piece
8146213-05	8	27	5	5	24,10
8146213-06	8	27	6	5	24,10

814623

Sprenger Seilrolle mit Gleitlager / Plastik
Sprenger rope sheave with slide bearing / Réa à friction Sprenger

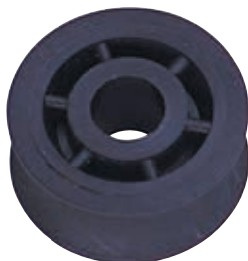

Artikel-Nr. Item-no.	Für Seil-Ø For rope-Ø	Rollen-Ø Sheave-Ø	Achse Pivot	Box	*€/Stück *€/piece
8146233-08 30	8	30	8,2	5	10,30
8146233-10 35	10	35	8,2	5	12,00
8146233-10 46	10	46	8,2	5	13,20
8146233-12 50	12	50	8,2	5	14,00

Klappen, Blöcke und Bolzen

Cleats, blocks and bolts
Taquets, poulies et cadènes

7



Sprenger Schotklemme / Plastik

Sprenger cam cleat / Sprenger taquet

814633

Artikel-Nr. Item-no.	Für Seil-Ø For rope-Ø	A	BD	Box	*€/Stück *€/piece
814633303	3-6	29	4	1	38,60
814633308	8-13	40	5	1	53,80



Sprenger Schotklemme mit Führung / A2-AISI 304 / Plastik

Sprenger cam cleat with rope lead / Sprenger taquet à filoir

814634

Artikel-Nr. Item-no.	Für Seil-Ø For rope-Ø	A	BD	Box	*€/Stück *€/piece
814634303	3-6	29	4	1	55,10
814634308	8-13	40	5	1	74,90

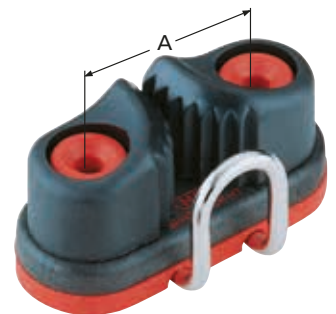

Sprenger Schotklemme mit Spezialführung / A2-AISI 304 / Plastik

Sprenger cam cleat with special rope lead / Sprenger taquet à filoir spécial

814635

Artikel-Nr. Item-no.	Für Seil-Ø For rope-Ø	A	BD	Box	*€/Stück *€/piece
814635308	8-13	40	5	1	76,90

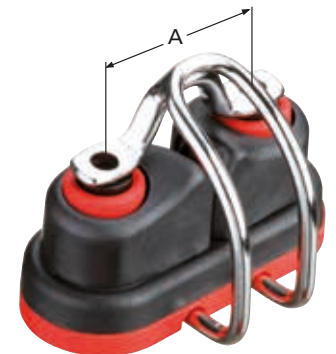

7

Schotklemme mit Führung / A4-AISI 316

Cam cleat with rope lead / Taquet à filoir spécial

814716

Artikel-Nr. Item-no.	Für Seil-Ø For rope-Ø	A	Box	*€/Stück *€/piece
814716403	3-6	40	1	71,80

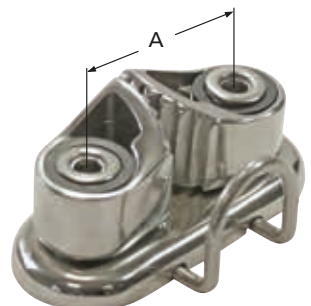

Klampen, Blöcke und Bolzen

Cleats, blocks and bolts

Taquets, poulies et cadènes



814636

Sprenger Unterlegkeil für Schotklemme, 15° / PA
Sprenger wedge for cam cleat, 15° / Sprenger cale pour taquet, 15°

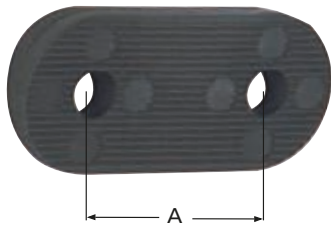

Artikel-Nr. Item-no.	A	BD	Box	*€/Stück *€/piece
814636303	29	4	1	11,00
814636308	40	5	1	12,00

8344

Fallenaustritt / A2-AISI 304
Halyard exit plate / Sortie de drisse

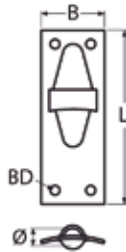

Artikel-Nr. Item-no.	Ausführung Execution	L	B	Seil max. Ø Rope max. Ø	BD	Box	*€/Stück *€/piece
83442GEBOGEN	Gebogen Curved	83	32	12	5	10	4,40
83442GERADE	Gerade Straight	83	32	12	5	10	4,60

814624

Sprenger Genuaschiene / Alu eloxiert
Sprenger genua track rail - Alu anodized / Sprenger rail génois - Alu anodisé

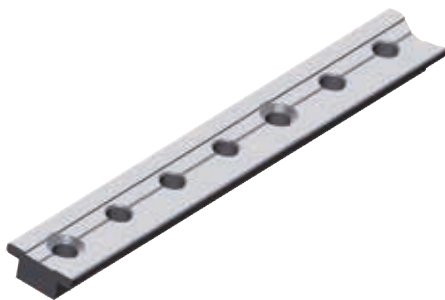

Artikel-Nr. Item-no.	Profil Profile	L	Box	*€/Stück *€/piece
81462400300	20x3	300	2	30,50
81462400400	20x3	400	2	34,80
81462400500	20x3	500	2	45,90
81462401000	20x3	1000	2	79,50
81462401500	20x3	1500	2	118,60

Empfohlen für Boote bis 7m Länge.
Recommended for boat length max. 7m.
Recommandé pour les bateaux jusqu'à 7m de longueur.

814625

Sprenger Genuaschiene / Alu eloxiert
Sprenger genua track rail - Alu anodized / Sprenger rail génois - Alu anodisé



Artikel-Nr. Item-no.	Profil Profile	Länge Length	Box	*€/Stück *€/piece
81462501000	25x4	1000	2	86,00
81462501500	25x4	1500	2	128,00
81462502000	25x4	2000	2	170,70

Empfohlen für Boote bis 9m Länge.
Recommended for boat length max. 9m.
Recommandé pour les bateaux jusqu'à 9m de longueur.

Klampen, Blöcke und Bolzen

Cleats, blocks and bolts
Taquets, poulies et cadènes

7



Sprenger Schienenendstück / Plastik

Sprenger track rail end stop / Sprenger rail embout

814626

Artikel-Nr. Item-no.	Für Profil For Profile	Box	*€/Stück *€/piece
814626320	20x3	10	5,30
814626325	25x4	10	7,00



Sprenger Genuaschlitten mit Rolle / Alu eloxiert

Sprenger genua slider with roll - Alu anodized / Sprenger chariot génois avec poulie - Alu anodisé

814627

Artikel-Nr. Item-no.	Ausführung Type	Für Profil For profile	Rollen-Ø Sheave-Ø	L	Box	*€/Stück *€/piece
8146270S	Silber eloxiert Silver anodized	20x3	20x30	65	1	108,30
8146270B	Schwarz eloxiert Black anodized	20x3	20x30	65	1	123,60



8146270S



8146270B



Sprenger Genuaschlitten mit Bügel / A2-AISI 304

Sprenger sheet slider with bow / Sprenger chariot i'avale tout

814628

Artikel-Nr. Item-no.	Auge innen Eye inside	Für Profil For profile	L	Box	*€/Stück *€/piece
814628220	14x13	20x3	65	1	55,70



Sprenger Genuaschlitten mit Gabelkopf / A2-AISI 304

Sprenger genua slider with swivel fork / Sprenger chariot génois avec chape

814629

Artikel-Nr. Item-no.	Ausführung Type	Für Profil For profile	L	Box	*€/Stück *€/piece
814629220	Mit Wirbel With swivel	20x3	45	1	61,90

Pin-Ø = 5mm



Klampen, Blöcke und Bolzen

Cleats, blocks and bolts

Taquets, poulies et cadènes



814630

Sprenger Genuaschlitten mit Rolle / Alu eloxiert

Sprenger genua slider with roll - Alu anodized / Sprenger chariot génois avec poulie - Alu anodisé



81463005

8146300B

Artikel-Nr. Item-no.	Ausführung Type	Für Profil For profile	Rollen-Ø Sheave-Ø	L	Box	*€/Stück *€/piece
81463005	Silber eloxiert Silver anodized	25x4	40x25	88	1	166,20
8146300B	Schwarz eloxiert Black anodized	25x4	40x25	88	1	196,20



814631

Sprenger Genuaschlitten mit Bügel / A2-AISI 304

Sprenger genua slider with bow / Sprenger chariot génois avec anneau



Artikel-Nr. Item-no.	Auge innen Eye inside	Für Profil For profile	L	Box	*€/Stück *€/piece
814631225	26x13	25x4	65	1	83,70



814632

Sprenger Genuaschlitten mit Gabelkopf / A2-AISI 304

Sprenger genua slide with swivel fork / Sprenger chariot génois avec chape

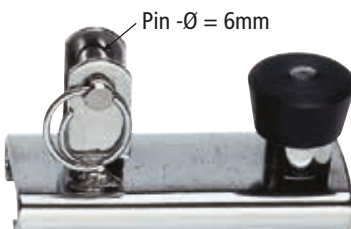

Artikel-Nr. Item-no.	Ausführung Type	Für Profil For profile	L	Box	*€/Stück *€/piece
814632225	Mit Wirbel With swivel	25x4	65	1	96,00

Genuaschlitten mit Gabelkopf / A4-AISI 316

Genua slide with swivel fork/ Chariot génois avec chape

8872

Artikel-Nr. Item-no.	Für Profil For profile	L	Box	*€/Stück *€/piece
8872425	25x4	64	1	33,00



Seil-Block mit Wirbelauge und Gelenk / A2-AISI 304

Rope block with swivel eye and joint / Poulie pour câble avec émerillon et joint

8369

Artikel-Nr. Item-no.	Für Seil-Ø For rope-Ø	L	D	iD	ø	**BL kg	Box	*€/Stück *€/piece
8369225	6	88	25	15	6	1240	1	8,70
8369232	8	104	32	15	6	1360	1	12,30
8369250	10	142	50	20	8	1940	1	24,80

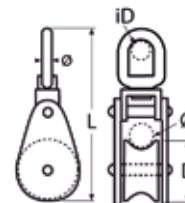

Seil-Block mit Wirbelauge / A2-AISI 304

Rope block with swivel eye / Poulie pour câble avec émerillon

8393

Artikel-Nr. Item-no.	Für Seil-Ø For rope-Ø	L	D	iD	ø	**BL kg	Box	*€/Stück *€/piece
8393215	4	60	15	12	3,5	820	1	5,70
8393220	5	73	20	13	5,0	930	1	7,00
8393225	6	83	25	15	6,0	1240	1	8,10
8393232	8	96	32	15	6,0	1360	1	12,60
8393250	10	130	50	20	8,0	1940	1	18,70

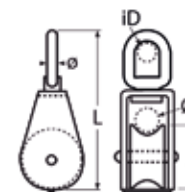

Seil-Block mit Wirbelauge und Hundsfott / A2-AISI 304

Rope block with swivel eye and becket / Poulie pour câble avec émerillon et ringot

814981

Artikel-Nr. Item-no.	Für Seil-Ø For rope-Ø	L	D	iD	iD1	ø	**BL kg	Box	*€/Stück *€/piece
814981225	6	100	25	15	10	6	1240	1	10,20
814981232	8	109	32	15	10	6	1360	1	13,60
814981250	10	144	50	20	12	8	1940	1	17,70

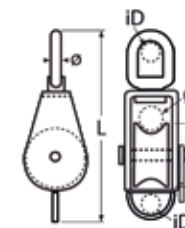

Klampen, Blöcke und Bolzen

Cleats, blocks and bolts

Taquets, poulies et cadènes

814982

Seil-Doppelblock mit Wirbelauge, Rolle entnehmbar / A2-AISI 304

Rope double block with swivel eye, roll removable / Poulie pour câble double avec émerillon, amovible

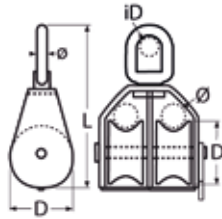

Artikel-Nr. Item-no.	Für Seil-Ø For rope-Ø	L	D	iD	ø	**BL kg	Box	*€/Stück *€/piece
814982225	6	83	25	15	6	1240	1	13,50
814982232	8	97	32	15	6	1360	1	17,20
814982250	10	127	50	20	8	1940	1	27,00

814983

Seil-Block mit Wirbelauge, Rolle entnehmbar / A2-AISI 304

Rope block with swivel eye, roll removable / Poulie pour câble avec émerillon, poulie amovible

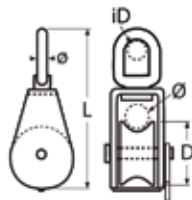

Artikel-Nr. Item-no.	Für Seil-Ø For rope-Ø	L	D	iD	ø	**BL kg	Box	*€/Stück *€/piece
814983215	4	60	15	12	3,5	820	1	6,40
814983220	5	73	20	13	5,0	930	1	7,60
814983225	6	83	25	15	6,0	1240	1	8,10
814983232	8	97	32	15	6,0	1360	1	10,00
814983250	10	127	50	20	8,0	1940	1	19,40

8390

Seil-Doppelblock mit Wirbelauge und Gelenk / A2-AISI 304

Rope double block with swivel eye and joint / Poulie pour câble double avec émerillon et joint

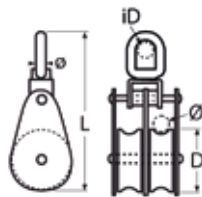

Artikel-Nr. Item-no.	Für Seil-Ø For rope-Ø	L	D	iD	ø	**BL kg	Box	*€/Stück *€/piece
8390225	6	88	25	15	5	690	1	32,10
8390232	8	104	32	16	6	1160	1	35,10
8390250	10	143	50	20	8	1940	1	44,20

8392

Seil-Block mit Wirbelauge, flach / A2-AISI 304

Rope block with swivel eye, flat / Poulie pour câble avec émerillon, plat

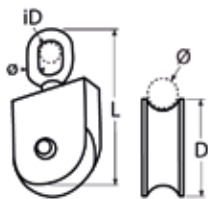

Artikel-Nr. Item-no.	Für Seil-Ø For rope-Ø	L	D	iD	ø	**BL kg	Box	*€/Stück *€/piece
83922050	10	122	50	20	8	1940	1	21,00
83922075	12	175	75	23	10	2800	1	36,50
83922100	16	205	100	23	12	3270	1	67,90

Klappen, Blöcke und Bolzen

Cleats, blocks and bolts
Taquets, poulies et cadènes

7

Seil-Klappblock mit Wirbelauge / A4-AISI 316 / A2-AISI 304

Rope snatch block with swivel eye / Poulie pour câble à passage rapide avec émerillon

8402

Artikel-Nr. A4 Item-no. A4	Artikel-Nr. A2 Item-no. A2	Für Seil-Ø For rope-Ø	L	D	iD	ø	**BL kg	Box	*€/Stück A4 *€/piece A4	*€/Stück A2 *€/piece A2
84024050	NEW 84022050	14	155	50	19	8	1560	1	52,40	40,70
84024075	NEW 84022075	15	222	75	24	10	1560	1	95,73	82,70

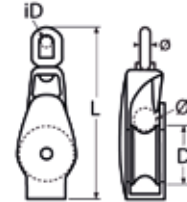

Seil-Block mit Wirbelkarabiner / A2-AISI 304

Rope block with swivel hook / Poulie pour câble avec crochet, émerillon

8395

Artikel-Nr. Item-no.	Für Seil-Ø For rope-Ø	L	D	**BL kg	Box	*€/Stück *€/piece
83952075	15	256	75	1700	1	90,70
83952100	16	315	100	1700	1	170,10



Reffleinenrolle für Relingsstütze / A2-AISI 304

Stanchion furling block / Poulie de chandelier

8526

Artikel-Nr. Item-no.	Ausführung Type	Für Seil-Ø For rope-Ø	Für Rohr-Ø For tube-Ø	L	L1	B	B1	D	Box	*€/Stück *€/piece
85262FEST	Feststehend Fixed	12	25	65	40	63	36	25	1	34,30
85262WIRBEL	Mit Wirbel With swivel	12	25	80	50	63	36	25	1	45,30

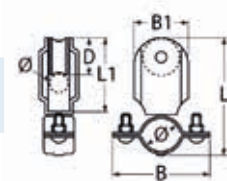

U-Bolzen mit Gegenplatte / A2-AISI 304

U-bolt with counter plate / Cadène avec plaque

8230

Artikel-Nr. Item-no.	GW	ø	L	L1	A	S	Antrieb Drive	Box	*€/Stück *€/piece
8230204 064	M4	3,5	64	35	30	2	SW7	10	1,50
8230205 080	M5	4,4	80	47	35	2	SW8	10	1,80
8230206 090	M6	5,3	90	50	35	2	SW10	10	1,90
8230208 080	M8	7,1	80	43	35	2	SW13	10	2,90
8230208 100	M8	7,1	100	57	35	2	SW13	10	3,00
8230210 090	M10	9,0	90	47	50	2	SW17	5	5,00
8230210 130	M10	9,0	130	67	50	2	SW17	5	6,30
8230212 150	M12	10,8	150	78	60	2	SW19	5	8,10

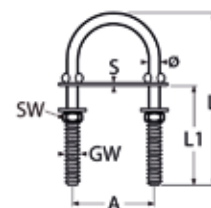

7

Klampen, Blöcke und Bolzen

Cleats, blocks and bolts

Taquets, poulies et cadènes

8651

U-Bolzen mit 2 Gegenplatten / A4-AISI 316

U-bolt with 2 counter plates / Cadène avec 2 plaques

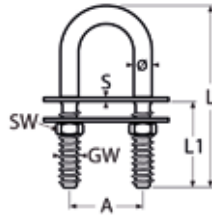

Artikel-Nr. Item-no.	GW	ø	L	L1	A	S	Antrieb Drive	Box	*€/Stück *€/piece
8651408 100	M8	10	100	50	45	2	SW13	1	9,50
8651410 100	M10	12	100	48	40	2	SW17	1	16,30
8651412 120	M12	14	120	78	47	2	SW19	1	21,60

815175

U-Bolzen mit 2 Gegenplatten und 4 Muttern / A4-AISI 316

U-bolt with 2 counter plates and 4 nuts / Cadène avec 2 plaques et 4 écrous

NEW

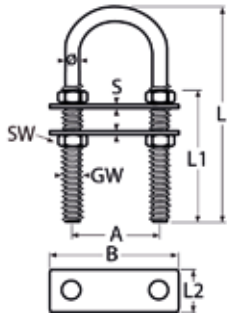

Artikel-Nr. Item-no.	GW	ø	L	L1	A	S	B	L2	Antrieb Drive	Box	*€/Stück *€/piece
815175412 130	M12	12	130	85	53	2	90	30	SW19	5	13,60

814223

U-Bolzen mit 2 Gegenplatten und Abreissmutter / A4-AISI 316

U-bolt with 2 counter plates and shear nuts / Cadène avec 2 plaques et écrou auto-cassant

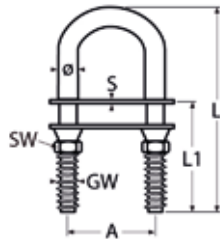

Artikel-Nr. Item-no.	GW	ø	L	L1	A	S	Antrieb Drive	Box	*€/Stück *€/piece
814223408 100	M8	10	100	58	42	2	SW13	5	12,70
814223410 100	M10	12	100	48	38	2	SW17	5	14,80
814223412 120	M12	14	120	58	50	2	SW19	2	22,20

814906

U-Bolzen, schwere Ausführung / A4-AISI 316

U-Bolt, heavy duty / Cadène lourde

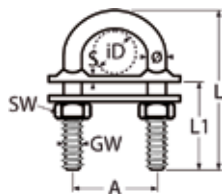

Artikel-Nr. Item-no.	GW	ø	L	L1	A	iD	S	Antrieb Drive	Box	*€/Stück *€/piece
814906410 100	M10	10	100	63	35,7	25	3	SW17	1	26,70
814906410 126	M10	10	126	87	35,7	25	3	SW17	1	27,00
814906412 110	M12	12	110	63	46,0	31	3	SW19	1	36,00
814906412 122	M12	12	122	75	46,0	31	3	SW19	1	39,00

Klappen, Blöcke und Bolzen

Cleats, blocks and bolts
Taquets, poulies et cadènes

7

Triangel-Bolzen mit 2 Gegenplatten / A4-AISI 316

Triangle bolt with 2 counter plates / Cadène triangulaire avec 2 plaques

8979

Artikel-Nr. Item-no.	Ausführung Type	ø	GW	L	L1	A	S	Antrieb Drive	Box	*€/Stück *€/piece
897940800	0°	8	M8	100	50	41	2	SW13	10	15,00
897940808	8°	8	M8	100	50	41	2	SW13	10	15,00
897940818	18°	8	M8	100	50	41	2	SW13	10	15,00
897941000	0°	10	M10	120	60	50	2	SW16	5	20,50
897941008	8°	10	M10	120	60	50	2	SW16	5	20,50
897941018	18°	10	M10	120	60	50	2	SW16	5	20,50

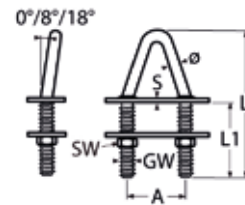

U-Bolzen mit Auge / A4-AISI 316

U-bolt with eye / Cadène avec levage

814112

Artikel-Nr. Item-no.	GW	ø	L	L1	A	iD	Box	*€/Stück *€/piece
814112425	M10	8	121	64	29	25	5	12,00

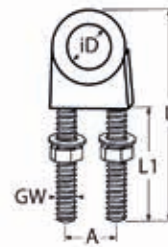

Augbolzen mit metrischem Gewinde / A4-AISI 316

Eye bolt with metric thread / Piton à œillet avec filetage métrique

8267

Artikel-Nr. Item-no.	GW	L1	iD	ø	**BL kg	Box	*€/Stück *€/piece
8267406 040V	M6	40	15	5	980	20	1,40
8267406 060V	M6	60	15	5	980	20	1,70
8267406 080V	M6	80	15	5	980	20	2,00
8267408 060V	M8	60	19	6	1300	20	2,20
8267408 080V	M8	80	19	6	1300	20	2,60
8267408 100V	M8	100	19	6	1300	20	2,80
8267410 100V	M10	100	25	8	1800	10	3,90
8267412 120V	M12	120	30	10	2500	10	7,50



NEW

Ringschraube mit langem Gewinde / A2-AISI 304

Eye screw with long thread / Vis à œillet avec filetage longue

815211

Artikel-Nr. Item-no.	GW	L1	iD	D	L	Box	*€/Stück *€/piece
815211210 150	M10	150	21	41	188	10	5,90
815211210 200	M10	200	21	41	238	10	6,70
815211210 250	M10	250	21	41	288	10	7,40
815211210 300	M10	300	21	41	338	10	8,30
815211212 150	M12	150	21	45	192	5	8,80
815211212 200	M12	200	21	45	242	5	9,90
815211212 250	M12	250	21	45	292	5	11,00
815211212 300	M12	300	21	45	342	5	12,00

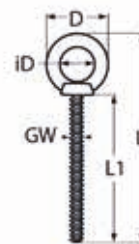

Klampen, Blöcke und Bolzen

Cleats, blocks and bolts

Taquets, poulies et cadènes

815020

Augbolzen mit metrischem Gewinde / A4-AISI 316

Eye bolt with metric thread / Piton à œil avec filetage métrique

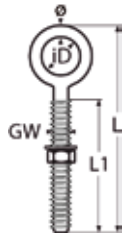

Artikel-Nr. Item-no.	GW	L	L1	iD	ø	**BL kg	Box	*€/Stück *€/piece
815020406 060	M6	60	30	13	6	770	10	1,20
815020406 080	M6	80	50	13	6	770	10	1,70
815020406 100	M6	100	74	13	6	770	10	1,80
815020408 100	M8	100	62	16	8	1390	10	2,70
815020408 110	M8	110	72	16	8	1390	10	2,90
815020408 130	M8	130	92	16	8	1390	10	3,10
815020410 100	M10	100	52	22	10	2180	5	3,70
815020410 150	M10	150	90	22	10	2180	5	4,80
815020412 165	M12	165	90	25	12	3200	2	7,70
815020412 185	M12	185	110	25	12	3200	2	7,90

815066

Augbolzen mit Kragen und metr. Gewinde, MT-Serie / A4-AISI 316

Eye bolt with collar and metric thread, MT-series / Piton à œil avec collier, filetage métr., MT-séries



NEW



Artikel-Nr. Item-no.	GW	L1	L2	iD	ø	Antrieb Drive	Box	*€/Stück *€/piece
815066406 040	M6	40	25,5	12,5	5	SW10	10	3,80
815066406 060	M6	60	25,5	12,5	5	SW10	10	3,90
815066408 050	M8	50	30,5	15,0	6	SW13	10	5,10
815066408 080	M8	80	30,5	15,0	6	SW13	10	5,40
815066408 100	M8	100	30,5	15,0	6	SW13	10	5,60
815066410 060	M10	60	40,5	20,0	8	SW17	5	8,00
815066410 100	M10	100	40,5	20,0	8	SW17	5	8,70
815066412 100	M12	100	50,0	25,0	10	SW19	5	12,90
815066412 160	M12	160	50,0	25,0	10	SW19	5	14,50

815064

Schraube mit Schäkel, metr. Gewinde, MT-Serie / A4-AISI 316 / PA

Screw with bow shackle, metric thread, MT-series / Vis avec manille lyre, filetage métrique, MT-série



NEW

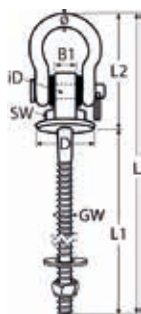

Artikel-Nr. Item-no.	GW	ø	L	L1	L2	D	iD	B1	Antrieb Drive	Box	*€/Stück *€/piece
815064408 170	M8	8	235	170	65	32	8,5	12	SW19	5	13,50

Augbolzen mit metrischem Gewinde und Ring / A4-AISI 316

Eye bolt with metric thread and ring / Piton à œil avec filetage métrique et anneau

815018

Artikel-Nr. Item-no.	GW	L1	L2	iD	ø	Box	*€/Stück *€/piece
815018406 060	M6	60	30	35	6	5	3,20
815018406 080	M6	80	50	35	6	5	3,40
815018406 090	M6	90	55	35	6	5	3,50
815018406 100	M6	100	74	35	6	5	3,60
815018408 100	M8	100	60	45	8	5	6,00
815018408 110	M8	110	72	45	8	5	6,80
815018408 130	M8	130	92	45	8	5	6,90
815018408 150	M8	150	112	45	8	5	7,00
815018410 130	M10	130	80	50	10	5	8,70
815018410 150	M10	150	90	50	10	5	8,80
815018412 120	M12	120	70	60	12	2	11,30
815018412 150	M12	150	90	60	12	2	12,80
815018412 185	M12	185	110	60	12	2	14,80

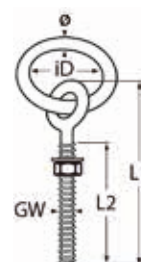

Ösenschraube mit metrischem Gewinde / A2-AISI 304

Screw eye with metric thread / Vis à œil avec filetage métrique

8473

Artikel-Nr. Item-no.	GW	L1	L2	iD	ø	Box	*€/Stück *€/piece
8473204 10	M4	10	9	6	3,5	20	0,18
8473204 20	M4	20	18	6	3,5	20	0,20
8473204 30	M4	30	27	6	3,5	20	0,22
8473204 40	M4	40	37	6	3,5	20	0,26
8473205 20	M5	20	18	8	4,4	10	0,30
8473205 30	M5	30	27	8	4,4	10	0,34
8473205 40	M5	40	37	8	4,4	10	0,40
8473205 50	M5	50	47	8	4,4	10	0,44
8473206 20	M6	20	18	10	5,3	10	0,50
8473206 30	M6	30	27	10	5,3	10	0,54
8473206 40	M6	40	37	10	5,3	10	0,60
8473206 50	M6	50	47	10	5,3	10	0,70
8473206 60	M6	60	57	10	5,3	10	0,76
8473208 30	M8	30	27	12	7,1	5	0,90
8473208 40	M8	40	37	12	7,1	5	0,96
8473208 50	M8	50	47	12	7,1	5	1,00
8473208 60	M8	60	57	12	7,1	5	1,16
8473208 70	M8	70	65	12	7,1	5	1,22
8473208 80	M8	80	77	12	7,1	5	1,30
8473210 70	M10	70	65	15	8,9	5	1,60

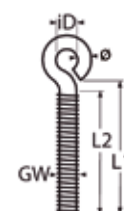

Klampen, Blöcke und Bolzen

Cleats, blocks and bolts

Taquets, poulies et cadènes

815210

Schraubhaken mit metrischem Gewinde / A2-AISI 304

Hook with metric thread / Crochets d'armoire à vis à filetage métrique

NEW

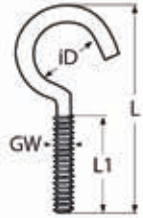

Artikel-Nr. Item-no.	GW	L	L1	iD	Box	*€/Stück *€/piece
815210205 50	M5	50	23	16	100	0,40
815210206 60	M6	60	30	18	100	0,60
815210208 80	M8	80	42	22	100	1,00

816014

Triangelschraube mit metrischem Gewinde / A2-AISI 304

Triangle screw with metr. Thread / Vis triangulaire avec filetage métrique

NEW

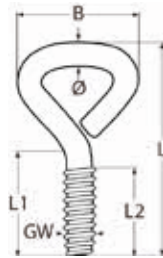

Artikel-Nr. Item-no.	GW	ø	L	L1	L2	B	Box	*€/Stück *€/piece
816014208 30	M8	8	64	30	25	35	10	1,50

816015

Ösenschraube mit metrischem Gewinde, oval / A2-AISI 304

Screw eye with metrical thread, oval / Vis à œil avec filetage métrique, ovale

NEW

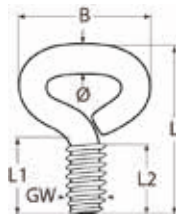

Artikel-Nr. Item-no.	GW	ø	L	L1	L2	B	Box	*€/Stück *€/piece
816015210 20	M10	10	55	29	20	40	5	2,50

814871

Spiralhaken mit metrischem Gewinde / A2-AISI 304

Curl hook with metric thread / Crochet en tire-bouchon avec filetage métrique

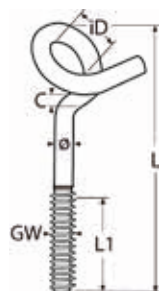

Artikel-Nr. Item-no.	GW	L	L1	iD	C	ø	Box	*€/Stück *€/piece
8148712088	M10	120	45	24	9,5	8,8	10	11,50

Klampen, Blöcke und Bolzen

Cleats, blocks and bolts
Taquets, poulies et cadènes

7

Haken mit Gewinde / A4-AISI 316

Hook with thread / Crochet à vis

814089

Artikel-Nr. Item-no.	L	L1	B	C	GW	Box	*€/Stück *€/piece
814089408	89	41	36	16	5/16"	10	6,60

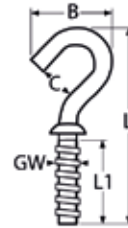

Flügelmutter / A4-AISI 316

Wing nut / Vis papillon

814967

Artikel-Nr. Item-no.	GW	B	H	H1	Box	*€/Stück *€/piece
814967408	M8	45,4	23,7	10,9	5	2,10
814967410	M10	61,6	29,5	11,8	5	3,20
814967412	M12	72,0	34,6	13,8	5	4,50
814967416	M16	86,5	40,0	15,8	2	5,80
814967420	M20	108,5	49,0	19,8	2	10,90

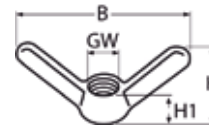

Augbolzen mit Flügelmutter / A4-AISI 316

Eye bolt with wing nut / Piton à œil avec vis papillon

814968

Artikel-Nr. Item-no.	GW	L	L1	iD	Box	*€/Stück *€/piece
814968410 073	M10	73	44	10	2	7,30
814968410 093	M10	93	64	10	2	7,60
814968410 113	M10	113	84	10	2	8,00
814968410 134	M10	134	104	10	2	8,50
814968412 096	M12	92	60	12	2	9,30
814968412 136	M12	112	80	12	2	12,90
814968412 154	M12	132	100	12	2	13,20
814968412 163	M12	163	130	12	2	13,40
814968416 074	M16	74	35	16	1	13,60
814968416 096	M16	96	55	16	1	13,90
814968416 119	M16	119	75	16	1	15,10
814968416 140	M16	140	95	16	1	16,60
814968416 163	M16	163	135	16	1	20,80

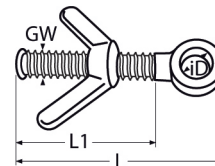



815067

Augbolzen mit Kragen und Holzgewinde, MT-Serie / A4-AISI 316

Eye bolt with collar and wood thread, MT-series / Piton à œil avec collier, filetage bois, MT-séries

NEW

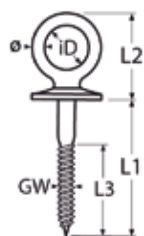

Artikel-Nr. Item-no.	GW	L1	L2	L3	iD	ø	Box	*€/Stück *€/piece
815067406 040	6	40	25,5	30	12,5	5	10	3,40
815067406 060	6	60	25,5	35	12,5	5	10	3,50
815067408 050	8	50	30,5	40	15,0	6	10	4,00
815067408 080	8	80	30,5	50	15,0	6	10	4,60
815067408 100	8	100	30,5	50	15,0	6	10	5,00
815067410 060	10	60	40,5	35	20,0	8	5	6,70
815067410 100	10	100	40,5	50	20,0	8	5	7,60
815067412 100	12	100	50,0	50	25,0	10	5	11,00
815067412 160	12	160	50,0	80	25,0	10	5	12,60

8271

Augbolzen mit Holzgewinde / A4-AISI 316

Eye bolt with wood thread / Piton à œil avec filetage bois



Artikel-Nr. Item-no.	GW	L1	L2	iD	ø	Box	*€/Stück *€/piece
8271405 50	5	50	30	11	4	10	1,80
8271406 40	6	40	25	14	5	10	1,90
8271406 60	6	60	35	14	5	10	2,40
8271406 80	6	80	50	14	5	10	2,50
8271406 100	6	100	60	14	5	10	3,00
8271408 60	8	60	35	18	6	10	3,20
8271408 80	8	80	50	18	6	10	4,40
8271408 100	8	100	60	18	6	10	4,50
8271410 80	10	80	50	22	8	5	6,70
8271410 100	10	100	60	22	8	5	7,60
8271410 120	10	120	80	22	8	5	7,70
8271412 100	12	100	60	25	10	5	9,20
8271412 120	12	120	80	25	10	5	12,20

815065

Schraube mit Schäkel, Holzgewinde, MT-Serie / A4-AISI 316 / PA

Screw with bow shackle, wood thread, MT-series / Vis avec manille lyre, filetage bois, MT-série



NEW

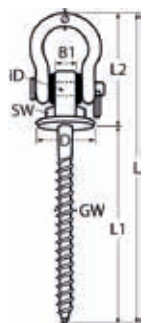

Artikel-Nr. Item-no.	GW	ø	L	L1	L2	D	iD	B1	Antrieb Drive	Box	*€/Stück *€/piece
815065408 080	M8	8	155	90	65	32	8,5	12	SW19	5	11,90

Augbolzen mit Holzgewinde und Ring / A4-AISI 316

Eye bolt with wood thread and ring / Piton à oeil fermé filtage bois + anneau

815019

Artikel-Nr. Item-no.	GW	L1	L2	iD	ø	Box	*€/Stück *€/piece
815019406 060	6	60	35	35	6	5	2,90
815019408 060	8	60	35	45	8	5	5,80
815019408 080	8	80	50	45	8	5	6,10
815019410 100	10	100	60	50	10	5	14,50



Augbolzen mit Holzgewinde / A4-AISI 316

Eye bolt with wood thread / Piton à oeil avec filetage bois

8974

Artikel-Nr. Item-no.	GW	L1	L2	iD	B	Box	*€/Stück *€/piece
8974406040	6	40	30	6,3	7	10	1,50
8974406050	6	50	35	6,3	7	10	1,60
8974406060	6	60	40	6,3	7	10	1,70
8974408060	8	60	40	8,4	9	10	2,20
8974408080	8	80	55	8,4	9	10	2,30
8974408100	8	100	65	8,4	9	10	2,50
8974410080	10	80	55	10,2	11	5	3,30
8974410100	10	100	65	10,2	11	5	4,20
8974410120	10	120	80	10,2	11	5	4,50
8974412100	12	100	65	12,1	13	5	9,40
8974412120	12	120	80	12,1	13	5	9,60

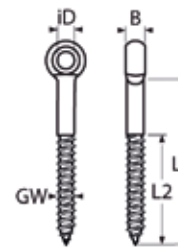

Augbolzen mit Holzgewinde und Ring / A4-AISI 316

Eyebolt with wood thread and ring / Piton à oeil avec filetage bois et anneau

814086

Artikel-Nr. Item-no.	GW	L1	L2	iD	ø	Box	*€/Stück *€/piece
814086404045	4	45	30	25	4	10	3,00
814086405050	5	50	35	30	5	10	3,10
814086406060	6	60	40	30	6	10	3,70
814086408080	8	80	55	50	8	10	7,20
814086410100	10	100	65	60	10	5	9,10
814086412120	12	120	80	75	12	5	22,20

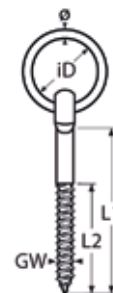

Klampen, Blöcke und Bolzen

Cleats, blocks and bolts

Taquets, poulies et cadènes

8316

Ösenschraube mit Holzgewinde / A4-AISI 316

Screw eye with wood thread / Vis à œil avec filetage bois



Artikel-Nr. Item-no.	L1	L2	iD	ø	Box	*€/Stück *€/piece
8316416 8	16	9	8	3,3	10	0,80
8316420 10	20	13	10	3,3	10	1,00
8316425 12	25	17	12	3,9	10	1,20
8316430 14	30	17	14	3,9	10	1,40

8317

Schraubhaken mit Holzgewinde / A4-AISI 316

Screw hook with wood thread / Crochet avec filetage bois

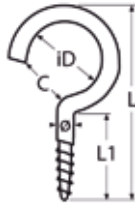

Artikel-Nr. Item-no.	L	L1	iD	C	ø	Box	*€/Stück *€/piece
8317429 40	40	22	12	9,7	2,9	100	0,60
8317433 50	50	26	16	13,1	3,3	100	0,70
8317433 60	60	35	16	13,1	3,3	100	0,90
8317444 50	50	24	16	13,1	4,4	50	1,10
8317448 65	65	31	22	17,3	4,8	50	1,60
8317452 80	80	42	26	22,3	5,2	20	2,10
8317458 100	100	62	26	20,3	5,8	20	3,30

814869

Schraubhaken mit Holzgewinde / A2-AISI 304

Square hook with wood thread / Crochet avec filetage bois



Artikel-Nr. Item-no.	GW	L	L1	H	ø	Box	*€/Stück *€/piece
8148692330	4,1	40	17	16	3,30	100	0,80
8148692345	4,3	50	20	18	3,45	100	0,90
8148692400	5,1	60	25	20	4,00	100	1,10
8148692440	5,5	80	32	22	4,40	100	1,50
8148692525	6,5	100	30	24	5,25	100	2,90

814870

Spiralhaken mit Holzgewinde / A2-AISI 304

Curl hook with wood thread / Crochet spiral avec filetage bois

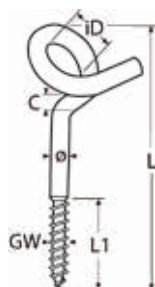

Artikel-Nr. Item-no.	GW	L	L1	iD	C	ø	Box	*€/Stück *€/piece
8148702088	8,8	120	41	24	9,5	8,8	10	15,90

Klappen, Blöcke und Bolzen

Cleats, blocks and bolts
Taquets, poulies et cadènes

7

Ösenschraube mit Holzgewinde, schwer / A4-AISI 316

Screw eye with wood thread, heavy duty / Vis à œil lourde avec filetage bois

8976

Artikel-Nr. Item-no.	L	L1	L2	iD	ø	Box	*€/Stück *€/piece
8976406060	62	34	25	16	6	10	1,30
8976406100	100	72	52	14	6	10	1,60
8976408085	84	49	32	20	8	5	2,00
8976408110	108	70	52	20	8	5	2,30
8976410125	125	76	54	30	10	5	5,10

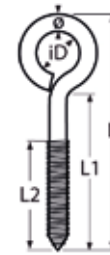

Bügelmutter / A4-AISI 316

Lifting eye nut oval / Ecrou à anse

814110

Artikel-Nr. Item-no.	GW	L	iL	iB	D	ø	Box	*€/Stück *€/piece
814110412	M12	47	19	36	33	10	5	21,00

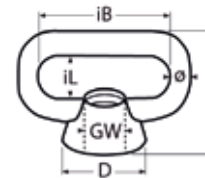

Bügelschraube / A4-AISI 316

Lifting eye bolt oval / Vis à anse

814111

Artikel-Nr. Item-no.	GW	L	L1	iL	iB	ø	Box	*€/Stück *€/piece
814111412 123	M12	123	76	19	36	10	5	30,00
814111412 149	M12	149	102	19	36	10	2	32,20

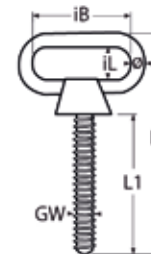

Ringmutter gegossen ähnlich DIN 582 / A2-AISI 304 / A4-AISI 316

Lifting eye nut cast similar to DIN 582 / Ecrou à anneau moule similaire DIN 582

8268

Artikel-Nr. A2 Item-no. A2	Artikel-Nr. A4 Item-no. A4	GW	iD	D	L	Box	*€/Stück A2 *€/piece A2	*€/Stück A4 *€/piece A4
8268203	8268403	M3	7,5	13,5	14,0	20	2,80	3,20
8268204	8268404	M4	10,0	18,0	19,5	20	2,40	2,80
8268205	8268405	M5	12,5	22,5	23,5	20	1,60	2,00
8268206	8268406	M6	16,0	28,0	28,0	20	1,20	1,50
8268208	8268408	M8	20,0	36,0	33,0	20	1,60	2,00
8268210	8268410	M10	25,0	45,0	42,0	10	3,20	3,80
8268210 ID21	–	M10	21,0	41,0	38,0	10	3,00	–
8268212	8268412	M12	30,0	54,0	51,0	10	5,00	6,00
8268212 ID21	–	M12	21,0	45,0	42,0	10	4,60	–
8268216	8268416	M16	35,0	63,0	60,0	5	9,00	10,50
8268220	8268420	M20	40,0	72,0	69,0	5	11,20	14,20

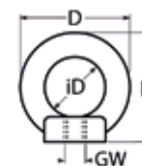

NEW

NEW

8261

Ringmutter geschmiedet DIN 582 / A4-AISI 316

Lifting eye nut forged DIN 582 / Ecroû à anneau forgé DIN 582

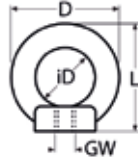

Artikel-Nr. Item-no.	GW	iD	D	L	BL kg	AL kg WLL kg	Box	*€/Stück *€/piece
8261406	M6	16	28	31	440	75	25	4,80
8261408	M8	20	36	36	830	140	25	5,00
8261410	M10	25	45	45	1370	230	25	8,00
8261412	M12	30	54	53	2030	340	10	12,10
8261416	M16	35	63	62	4200	700	10	18,70
8261420	M20	40	72	71	7190	1200	10	28,40
8261424	M24	50	90	90	10800	1800	5	51,80
8261427	M27	60	108	109	12640	2100	5	73,00
8261430	M30	60	108	109	19270	3200	5	91,00
8261436	M36	70	126	128	27630	4600	1	182,00

Die Arbeitslast (AL) gilt nur in Axialrichtung und setzt voraus, dass die Ringmutter vollständig aufgeschraubt ist und vollflächig aufliegt.

The working load limit (WLL) only apply in axial direction and assume that the eye nut is screwed on completely and lies flat over the entire surface.

La charge maximale d'utilisation (CMU) appliquent uniquement dans le sens axial et supposent que l'écrou à anneau est complètement vissée et repose à plat sur toute la surface.

815189

Ringmutter gegossen ähnlich DIN 582 mit Fingerschutz / A2-AISI 304

Eye nut cast similar to DIN 582 with finger protection / Ecroû à anneau moule similaire DIN 582 avec protégé-doigts

NEW

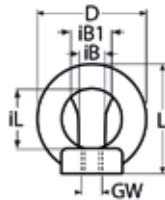

Artikel-Nr. Item-no.	GW	D	L	iL	iB	iB1	Box	*€/Stück *€/piece
815189208	M8	36	35	20	8,5	12	20	2,40

8272

Ringschraube gegossen, ähnlich DIN 580 / A2-AISI 304 / A4-AISI 316

Lifting eye bolt cast similar to DIN 580 / Vis à anneau moule similaire DIN 580

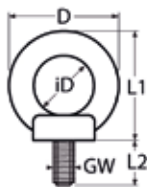

Artikel-Nr. A2 Item-no. A2	Artikel-Nr. A4 Item-no. A4	GW	iD	D	L1	L2	Box	*€/Stück A2 *€/piece A2	*€/Stück A4 *€/piece A4
8272203	8272403	M3	7,5	13,5	13,8	9	20	3,20	3,70
8272204	8272404	M4	10,0	18,0	19,0	10	20	2,80	3,20
8272205	8272405	M5	12,5	22,5	23,0	11	20	2,00	2,50
8272206	8272406	M6	16,0	28,0	28,0	11	20	1,60	2,00
8272208	8272408	M8	20,0	36,0	33,0	13	20	2,00	2,50
8272210	8272410	M10	25,0	45,0	42,0	17	10	3,50	4,20
8272212	8272412	M12	30,0	54,0	51,0	21	10	6,10	6,80
8272216	8272416	M16	35,0	63,0	60,0	27	5	8,70	10,00
8272220	8272420	M20	40,0	72,0	69,0	30	5	12,30	19,10

Klappen, Blöcke und Bolzen

Cleats, blocks and bolts

Taquets, poulies et cadènes

7

Ringschraube geschmiedet DIN 580 / A4-AISI 316

Lifting eye bolt forged DIN 580 / Vis à anneau forgé DIN 580

8269

Artikel-Nr. Item-no.	GW	iD	D	L1	L2	BL kg	AL kg WLL kg	Box	*€/Stück *€/piece
8269406	M6	16	28	31	13	440	75	25	5,10
8269408	M8	20	36	36	13	830	140	25	5,30
8269410	M10	25	45	45	17	1370	230	25	8,30
8269412	M12	30	54	53	21	2030	340	10	12,40
8269416	M16	35	63	62	27	4200	700	10	19,70
8269420	M20	40	72	71	30	7190	1200	10	29,40
8269424	M24	50	90	90	36	10800	1800	5	55,00
8269427	M27	60	108	109	45	12640	2100	5	76,00
8269430	M30	60	108	109	45	19270	3200	5	106,00
8269436	M36	70	126	128	54	27630	4600	1	195,00

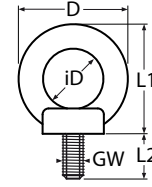

Die Arbeitslast (AL) gilt nur in Axialrichtung und setzt voraus, dass die Ringschraube vollständig eingeschraubt ist und vollflächig aufliegt.

The working load limit (WLL) only apply in axial direction and assume that the eye bolt is screwed in completely and lies flat over the entire surface.

La charge maximale d'utilisation (CMU) appliquent uniquement dans le sens axial et supposent que le vis à anneau est complètement vissée et repose à plat sur toute la surface.

Langaugenmutter / A4-AISI 316

Long eye nut / Écrou à anneau longue

8537

Artikel-Nr. Item-no.	GW	L	iL	B	iB	Box	*€/Stück *€/piece
853745	M5	24	12	18,0	10,0	10	1,50
853746	M6	30	15	22,5	12,5	10	2,30
853748	M8	37	19	27,0	15,0	10	2,50
8537410	M10	49	24	36,0	20,0	5	3,80

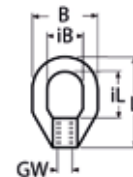

7

Doppel-Langaugenmutter / A4-AISI 316

Double long eye nut / Double écrou à anneau longue

8538

Artikel-Nr. Item-no.	GW	L	ø	Box	*€/Stück *€/piece
853845	M5	40	4	5	4,00
853846	M6	50	5	5	4,40
853848	M8	62	6	5	5,70
8538410	M10	80	8	5	7,60

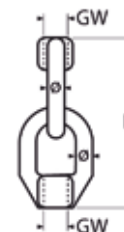



Yachtzubehör, Ausrüstung und Spezielles

Yachting accessories, equipment and highlights

Équipement et accessoires exclusifs pour yachts

Kapitel 8

Chapter 8



E-Artikel

Electrical appliances

Appareils électronique



Haken + Halter

Hooks + holder

Crochets + supports



Relingsbeschläge

Rail fittings

Embases + platines



Yachtzubehör + Ausrüstung

Yachting accessories + Equipment

Accessories pour yachts et equipment

8524

Wind King mit Reflektoren / A2-AISI 304

Wind King with reflectors / Girouette



Artikel-Nr. Item-no.	GW	L	H	Box	*€/Stück *€/piece
85242400	M8	400	335	1	55,00

8528

Tau-/Seilschneider für Antriebswelle / A4-AISI 316

Rope cutter for prop shaft / Coupe orin pour arbre d'hélice

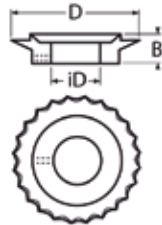

Artikel-Nr. Item-no.	D	iD	B	Box	*€/Stück *€/piece
8528425	79	25	18	1	175,00
8528430	79	30	18	1	175,00
8528435	79	35	18	1	175,00
8528440	79	40	18	1	175,00

Kein Verkauf nach Frankreich.

No sale to France.

Pas de vente en France.

8942

Eimer, hochglanzpoliert / Edelstahl AISI 201

Bucket, mirror polished / Seau, polie miroir



Artikel-Nr. Item-no.	Ausführung Type	H	D	Box	*€/Stück *€/piece
8942206	6L	230	210	1	57,60
8942210	10L	300	285	1	78,00

Heckleiter, klappbar / A4-AISI 316
 Foldable stern mount ladder / Echelle, pliable

8887

Artikel-Nr. Item-no.	Stufen Steps	L	L1	L2	B	Box	*€/Stück *€/piece
888743	3	630	235	395	254	1	206,00

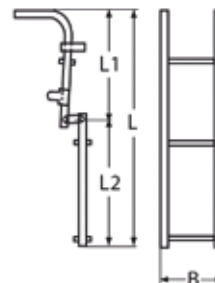

Teleskop Heckleiter / A4-AISI 316
 Telescopic stern mount ladder / Échelle télescopique

8867

Artikel-Nr. Item-no.	Stufen Steps	L	L1	B	Box	*€/Stück *€/piece
886743	3	700	450	200	1	135,00

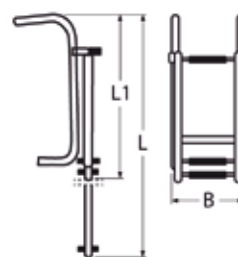

Teleskop Badeleiter für Montage unter Plattform / A4-AISI 316
 Telescopic bathing ladder for mounting under platform / Echelle télescopique pour montage sous plate-forme

8868

Artikel-Nr. Item-no.	Ausführung Type	Stufen Steps	L	L1	B	T	Box	*€/Stück *€/piece
886843	Schwarz/Black	3	700	310	270	240	1	331,00
88683TRITT	Ersatzstufe schwarz Replacement step black				165		1	4,00

NEW

Auch passend für 8887
 Also suitable for 8887
 Convient également pour 8887



88683TRITT

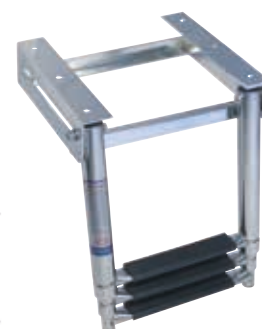
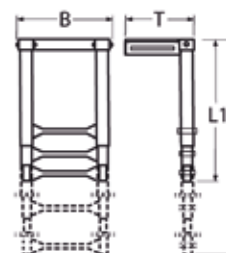

8437

Teleskop Badeleiter für Montage auf Plattform / A4-AISI 316

Telescopic bathing ladder for mounting on platform / Echelle télescopique pour montage sur plate-forme

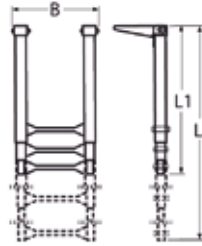

	Artikel-Nr. Item-no.	Ausführung Type	Stufen Steps	L	L1	B	Box	*€/Stück *€/piece
	843742	Schwarz/Black	2	570	370	280	1	170,00
NEW	843742W	Weiß/White	2	570	370	280	1	170,00
	843743	Schwarz/Black	3	870	410	305	1	240,00
NEW	843743W	Weiß/White	3	870	410	305	1	240,00
	843744	Schwarz/Black	4	1150	415	305	1	300,00
NEW	843744W	Weiß/White	4	1150	415	305	1	300,00
NEW	84373TRITT	Ersatzstufe schwarz Replacement step black				185	1	4,00
NEW	84373TRITTW	Ersatzstufe weiß Replacement step white				185	1	4,00

814044

Bugleiter mit ausziehbaren Bügeln / A4-AISI 316

Bow ladder with telescopic bows / Echelle d'étrave avec présentoir extensible

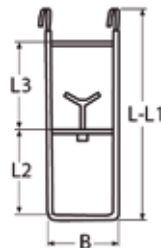

	Artikel-Nr. Item-no.	Stufen Steps	L - L1	B	L2	L3	Box	*€/Stück *€/piece
	81404443	3	750-1080	250	305	315	1	248,00

Fenderhalter mit Wirbel, klappbar / A2-AISI 304

Foldable fender holder with swivel / Support de pare-battage avec émerillon, pliable

8618

Artikel-Nr. Item-no.	Für Rohr-Ø For tube-Ø	iD	ø	Box	*€/Stück *€/piece
86184265	22, 25	250	8	1	110,00

Die Halterungen sind in unterschiedlichen Winkeln stufenlos montierbar.

Fender holder can be mounted continuously variably.

Les fixations peuvent être montés en continu sous différents angles.

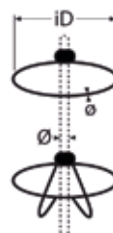

Fenderhalter, 2-fach, klappbar / A2-AISI 304

Foldable double fender holder / Support double de pare-battage, pliable

8607

Artikel-Nr. Item-no.	Für Rohr-Ø For tube-Ø	iD	ø	Box	*€/Stück *€/piece
86072200	22, 25	200	5	1	55,00

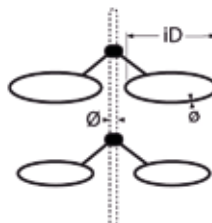

Fenderkorb, 2-fach, gerade / A2-AISI 304

Double fender holder, straight / Support double fixe de pare-battage

8641

Artikel-Nr. Item-no.	Für Rohr-Ø For tube-Ø	iD	L	B	H	H1	Box	*€/Stück *€/piece
86412140	22, 25	140	340	166	367	258	1	105,00
86412200	22, 25	233	476	233	428	283	1	183,00
86412300	22, 25	300	706	340	508	321	1	280,00

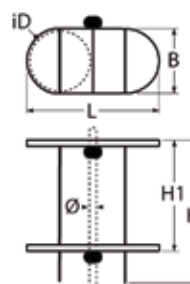

814661

Fenderhaken / A4-AISI 316

Fender hook / Crochet de pare-battage

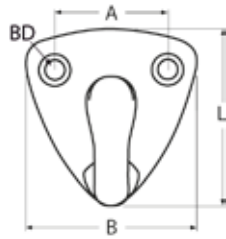

Artikel-Nr. Item-no.	L	B	A	BD	Box	*€/Stück *€/piece
8146614258	27	27	18	4,4	10	1,80

8291

Fenderhaken mit Schnappsicherung / A4-AISI 316

Fender hook with safety snap / Mousqueton pour pare-battage

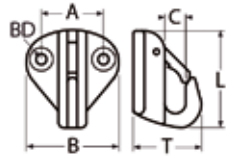

Artikel-Nr. Item-no.	L	B	A	T	C	BD	Box	*€/Stück *€/piece
8291405	36	34	17,8	24	8	3,5	5	4,10
8291410	42	34	19,5	34	10	3,5	5	4,80

814900

Fenderhaken mit Schnappsicherung, schmal / A4-AISI 316

Fender hook with safety snap, slim / Mousqueton pour pare-battage, étroit

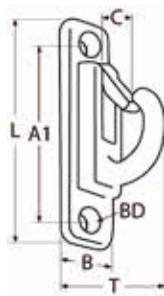

Artikel-Nr. Item-no.	L	B	A	T	C	BD	Box	*€/Stück *€/piece
814900470	70	17	55	34	15	4,4	5	4,80

8539

Fenderöse / A4-AISI 316

Fender eye / Pontet de pare-battage

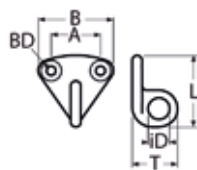

Artikel-Nr. Item-no.	L	B	A	T	iD	BD	Box	*€/Stück *€/piece
8539410	35	30	20	22	10	4,4	10	2,30

Yachtzubehör, Ausrüstung und Spezielles

Yachting accessories, equipment and highlights

Equipement et accessoires exclusifs pour yachts

8

Fenderauge / A4-AISI 316

Fender eye / Crochet œil pour pare-battage

814913

Artikel-Nr. Item-no.	ø	L	B	T	A	A1	iD	BD	Box	*€/Stück *€/piece
814913450	6,7	50	34	29	21	36	17	4,5	2	12,50

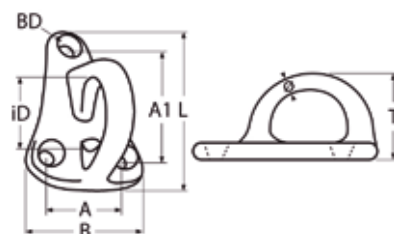

Fenderhalter mit Einhand-Bedienung / A4-AISI 316

Fender holder with one-hand operation / Crochet pour défenses

814916

Artikel-Nr. Item-no.	Ausführung Type	L	B	D	T	Für Seil-Ø For rope-Ø	BD	Box	*€/Stück *€/piece
814916453LOOP	Oval, Seilschleufe 30cm Oval, rope loop 30cm	53	35	-	17	6-8	4	1	31,50
814916453	Oval / Oval	53	32	-	17	6-10	4	1	33,60
814916463	Rund Round	-	-	36	17	6-10	4	1	33,00

Wir empfehlen Senkschrauben DIN 965 M4 oder Senk-Holzschrauben DIN 7997 4,0mm.
We recommend countersunk screws DIN 965 M4 or countersunk wood screws DIN 7997 4.0mm.
Nous recommandons des vis à tête fraisée DIN 965 M4 ou vis à bois à tête fraisée DIN 7997 4,0mm.

814916453LOOP

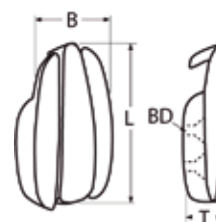

814916463

814916453

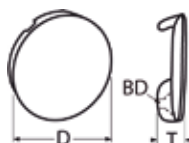

8

Yachtzubehör, Ausrüstung und Spezielles

Yachting accessories, equipment and highlights

Equipement et accessoires exclusifs pour yachts

814921

Fenderhaken Pop-out / A4-AISI 316

Fender hook pop-out / Bouton pour pare-battage

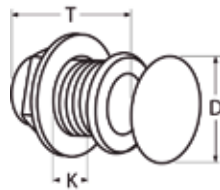

Artikel-Nr. Item-no.	Für Seil-Ø For rope-Ø	D	T	K	Box	*€/Stück *€/piece
814921434	6-8	34	60	3-20	1	75,50
814921447	8-13	47	81	4-25	1	109,50



814119

Fenderhalter / A4-AISI 316

Fender holder / Support de pare-battage

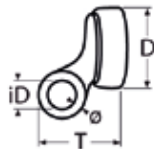

Artikel-Nr. Item-no.	D	iD	T	ø	Box	*€/Stück *€/piece
814119440	40	16	38	6	5	25,50

814132

Fenderhalter mit Drehverschluss / A4-AISI 316

Swivel fender holder / Support de pare-battage avec fermeture rotatif

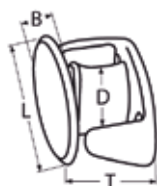

Artikel-Nr. Item-no.	L	B	D	T	Box	*€/Stück *€/piece
8141324	63	25	18	27	1	23,50

Spinnakerbaumhalter / A4-AISI 316 / Plastik
 Spinnaker pole holder / Supports de tangons pour chandelier

8461

Artikel-Nr. Item-no.	Für Rohr-Ø For tube-Ø	L	iL	iL1	D	ø	Box	*€/Stück *€/piece
8461490	25	150	61	19	107	8	1	66,00



Rettingsleinenhalter / A2-AISI 304
 Life line holder / Enrouleur de cordage

8422

Artikel-Nr. Item-no.	Ausführung Type	Für Rohr-Ø max For tube-Ø max.	iB	D	Box	*€/Stück *€/piece
84222WAAG	Waagrecht Horizontal	30	270	160	1	175,00
84222SENK	Senkrecht Vertical	30	270	160	1	193,00



84222SENK



Kapazität mit 6mm Leine ca. 160 m.
 Capacity with 6 mm rope about 160 m.
 Capacité avec corde de 6 mm environ 160 m.

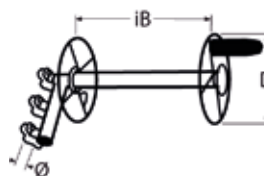

84222WAAG

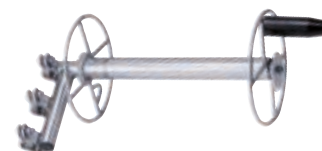

Flaggenstock mit Halter für Reling / A2-AISI 304 / Plastik
 Flag pole with socket for rail mount / Porte fanion avec support de chandelier

8444

Artikel-Nr. Item-no.	Für Rohr-Ø For tube-Ø	L	Box	*€/Stück *€/piece
8444222 25	22-25	430	1	22,50



8438

Flaggenstock mit Halter für Reling / A2-AISI 304 / Plastik
 Flag pole with socket for rail mount / Porte fanion avec support de chandelier



Artikel-Nr. Item-no.	Für Rohr-Ø For tube-Ø	L	Box	*€/Stück *€/piece
8438222	22	455	1	59,30
8438225	25	455	1	72,00

814133

Flaggenstock mit Halter 15°, versenkt / A4-AISI 316
 Flag pole with socket 15°, sunked / Porte fanion avec support 15°, fraisée

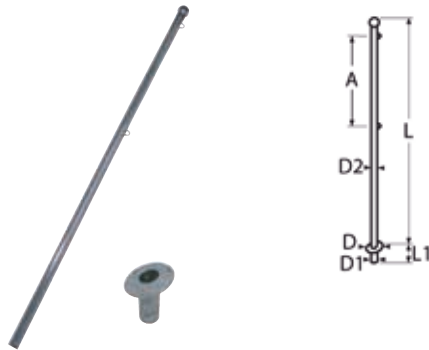

Artikel-Nr. Item-no.	L	L1	A	D	D1	D2	BD	Box	*€/Stück *€/piece
8141334	970	69	370	70	31	25	4,5	1	148,00

814717

Flaggenstock / A4-AISI 316
 Flag pole / Porte fanion



Artikel-Nr. Item-no.	L	D	Box	*€/Stück *€/piece
8147174620	620	25	1	42,00

Für Artikel-Nr.: 8586226
 For article-no. 8586226
 Pour article 8586226

8653

Flaggenstock / A2-AISI 304
 Flag pole / Porte fanion



Artikel-Nr. Item-no.	L	L1	D	Box	*€/Stück *€/piece
8653219	600	498	19	1	70,00

Für Artikel-Nr.: 8654419
 For article-no. 8654419
 Pour article 8654419

Flaggenstockfuß / A4-AISI 316
 Flag pole base / Embase pour porte fanion

8654

Artikel-Nr. Item-no.	Für Rohr-Ø For tube-Ø	L	B	A	A1	S	BD	Box	*€/Stück *€/piece
8654419	19	85	50	24	62	5	5	1	39,00

Für Artikel-Nr.: 8653219 "Flaggenstock"
 For article-no. 8653219 "Flag pole"
 Pour article 8653219 "Porte fanion"



Flaggenstockhalter versenkt, 60° / A4-AISI 316
 Flag pole socket, 60° / Support de hampe coulé, 60°

8587

Artikel-Nr. Item-no.	H	D	iD	D1	BD	Box	*€/Stück *€/piece
8587470	63	71	32	37	5,5	1	33,00

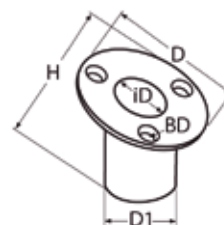

Flaggenstockhalter, 80° / A4-AISI 316
 Flag pole socket, 80° / Support de hampe structure, 80°

8586

Artikel-Nr. Item-no.	H	D	iD	S	BD	Box	*€/Stück *€/piece
8586426	50	65	26	6	5	1	58,50

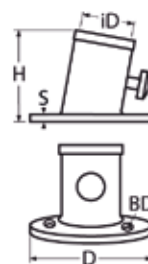

NEW

Flaggenstockhalter für Reling / A4-AISI 316
 Flag pole socket for rail mount / Support de porte fanion pour chandelier

815086

Artikel-Nr. Item-no.	Für Rohr-Ø For tube-Ø	L	H	iD	Box	*€/Stück *€/piece
8150864129	22-25	76	49	12,9	1	47,00
8150864165	22-25	76	49	16,5	1	47,00
8150864197	22-25	76	49	19,7	1	47,00
8150864228	22-25	76	49	22,8	1	47,00

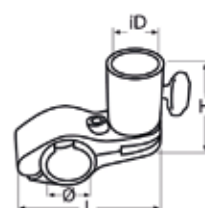

814114

Flaggenstockhalter für Reling / A4-AISI 316

Flag pole socket for rail mount / Support de porte fanion pour chandelier

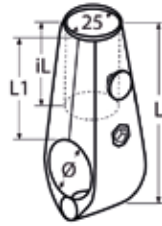

Artikel-Nr. Item-no.	Für Rohr-Ø For tube-Ø	L	L1	iL	Box	*€/Stück *€/piece
814114425	22, 25	80	47	35	1	75,50

Für Artikel-Nr.: 814717620 "Flaggenstock"

For article-no. 814717620 "Flag pole"

Pour article 814717620 "Porte fanion"

8599

Schwanenhals / A4-AISI 316

Gooseneck / Col de cygne

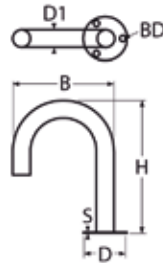

Artikel-Nr. Item-no.	H	B	D	D1	S	BD	Box	*€/Stück *€/piece
85994195	145	114	51	20	2,0	5,4	1	31,90
8599438	150	120	78	38	2,5	6,4	1	72,20

814217

Windhutze / A4-AISI 316

Cowl vent / Manche à air



Artikel-Nr. Item-no.	L	H	iH	D	Box	*€/Stück *€/piece
8142174105	190	105	70	125	1	320,00

8556

Inspektionsdeckel / A4-AISI 316

Inspection port / Couvercle d'inspection



8151494



85564SCHLÜSSEL

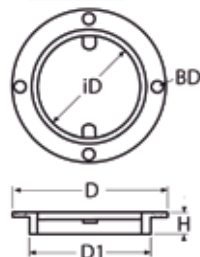

Artikel-Nr. Item-no.	D	D1	iD	H	BD	Box	*€/Stück *€/piece
85564100	140	110	100	20	5,3	1	91,00
85564SCHLÜSSEL	Schlüssel / Key					1	14,90

Nicht für Montage unterhalb der Wasserlinie geeignet!

Not suitable for mounting under the waterline!

Ne convient pas pour une installation sous la ligne de flottaison.

Inspektionsdeckel wird mit Drahtschlüssel (8151494, Seite 418) geliefert

Inspection port will be delivered including wire key (8151494, page 418)

Couvercle va être livré avec une clé à file (8151484, page 418)

Yachtzubehör, Ausrüstung und Spezielles

Yachting accessories, equipment and highlights

Equipement et accessoires exclusifs pour yachts

8

Inspektionsdeckel / A4-AISI 316

Inspection cover / Couverture d'inspection

814653

Artikel-Nr. Item-no.	D	D1	iD	H	BD	Box	*€/Stück *€/piece
8146534130	175	136	126	20	5,4	1	178,30

Nicht für Montage unterhalb der Wasserlinie geeignet!

Not suitable for mounting under the waterline!

Ne convient pas pour une installation sous la ligne de flottaison.

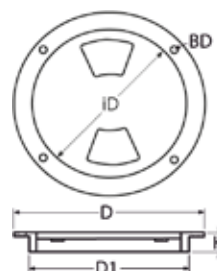

Inspektionsdeckel / Plastik

Inspection port plastic / Obturateur avec bouchon en plastic

814681

Artikel-Nr. Item-no.	D	D1	iD	H	BD	Farbe Colour	Box	*€/Stück *€/piece
8146813146W	146	115	100	16	4,3	Weiß / White	1	10,70
8146813146B	146	115	100	16	4,3	Schwarz / Black	1	10,70
8146813175W	175	138	123	16	4,3	Weiß / White	1	11,70
8146813175B	175	138	123	16	4,3	Schwarz / Black	1	11,70
8146813205W	205	163	148	16	4,3	Weiß / White	1	13,70
8146813205B	205	163	148	16	4,3	Schwarz / Black	1	13,70

Nicht für Montage unterhalb der Wasserlinie geeignet!

Not suitable for mounting under the waterline!

Ne convient pas pour une installation sous la ligne de flottaison.

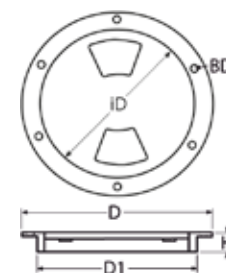

Kiemenblech / A4-AISI 316

Slotted vent / Grille d'aération

8370

Artikel-Nr. Item-no.	L	B	S	BD	Box	*€/Stück *€/piece
83704127 66	127	66	0,8	4	1	4,50

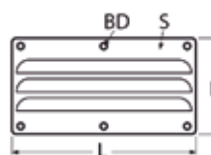

Kiemenblech / A4-AISI 316

Slotted vent / Grille d'aération

8371

Artikel-Nr. Item-no.	L	B	S	BD	Box	*€/Stück *€/piece
83714127 115	127	115	0,7	4	1	7,00

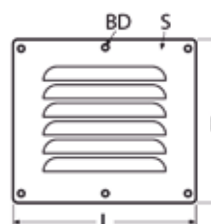

815176

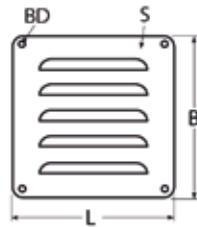
Kiemenblech, quadratisch / A4-AISI 316
Slotted square vent / Grille d'aération carrée**NEW**

Artikel-Nr. Item-no.	L	B	S	BD	Box	*€/Stück *€/piece
151764120 120	120	120	0,8	5	1	6,60

8372

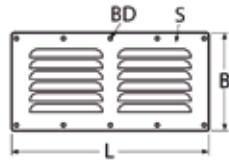
Kiemenblech / A4-AISI 316
Slotted vent / Grille d'aération

Artikel-Nr. Item-no.	L	B	S	BD	Box	*€/Stück *€/piece
83724230 115	230	115	0,8	4,4	1	10,00

815177

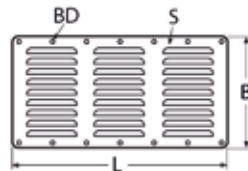
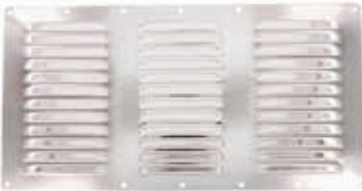
Kiemenblech / A4-AISI 316
Slotted vent / Grille d'aération**NEW**

Artikel-Nr. Item-no.	L	B	S	BD	Box	*€/Stück *€/piece
8151774358 184	358	184	0,8	4,4	1	22,20

8373

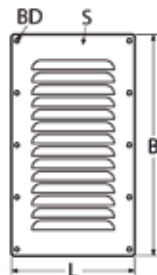
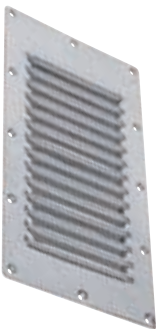
Kiemenblech / A4-AISI 316
Slotted vent / Grille d'aération

Artikel-Nr. Item-no.	L	B	S	BD	Box	*€/Stück *€/piece
83734228 127	127	228	1	4	1	11,00

Lüftungsblech / A4-AISI 316
 Round vent / Grille d'aération

814964

Artikel-Nr. Item-no.	D	S	BD	Box	*€/Stück *€/piece
814964482	82,5	1	3,7	10	3,55

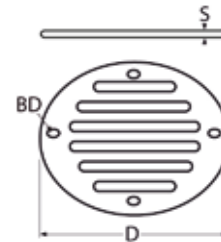

Kiemenblech rund / A4-AISI 316
 Slotted round vent / Grille d'aération ronde

8374

Artikel-Nr. Item-no.	D	S	BD	Box	*€/Stück *€/piece
83744100	100	1	3,3	1	7,00
83744153	153	1	3,3	1	13,00

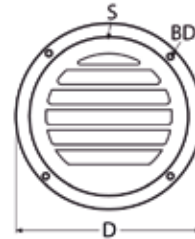

Kiemenblech / A4-AISI 316
 Slotted vent / Grille d'aération

814965

Artikel-Nr. Item-no.	L	B	H	S	BD	Box	*€/Stück *€/piece
8149654100	100	100	10	1	5,1	2	7,20
8149654130	130	130	10	1	5,1	2	8,70

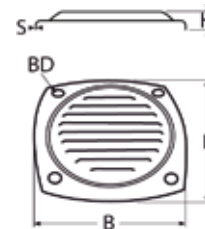

8

NEW

Kiemenblech, gegossen / A4-AISI 316
 Slotted vent, casted / Grille d'aération, moulé

815133

Artikel-Nr. Item-no.	L	B	H	BD	Box	*€/Stück *€/piece
8151334097	97	97	10	4,2	1	51,80
8151334129	129	129	10	4,2	1	68,80

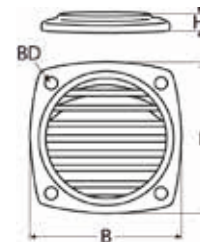

8151334129



8151334097

8375

Rundlüfter mit Drehverschluss / A4-AISI 316

Lockable round vent / Grille d'aération ronde avec fermeture rotatif



83754100



83754125

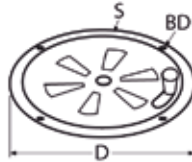

Artikel-Nr. Item-no.	D	S	BD	Box	*€/Stück *€/piece
83754100	100	0,8	3,5	1	11,10
83754125	125	0,8	3,5	1	12,50

814225

Lüftungsgitter / A2-AISI 304

Ventilation grid / Grille de ventilation

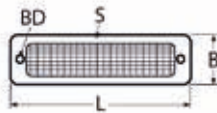

Artikel-Nr. Item-no.	L	B	S	BD	Box	*€/Stück *€/piece
8142252212	212	57	0,8	4,2	1	5,00

814927

Lüftungsgitter, oval / A4-AISI 316

Ventilation grid, oval / Grille de ventilation, ovale

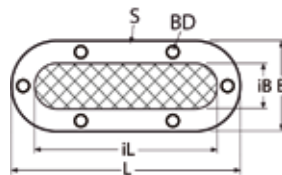

Artikel-Nr. Item-no.	L	iL	B	iB	S	BD	Box	*€/Stück *€/piece
8149274180 80	180	146	80	44	4,7	4,8	1	31,00

814073

Lüftungsblech / A4-AISI 316

Slotted vent / Grille d'aération



Artikel-Nr. Item-no.	Ausführung Type	L	B	H	Box	*€/Stück *€/piece
814073406	6 Schlitz / Slots	327	76	32	5	30,90
814073407	7 Schlitz / Slots	378	76	32	5	38,30
814073408	8 Schlitz / Slots	427	76	32	5	41,60
814073410	10 Schlitz / Slots	527	76	32	5	43,90

Lüftungsblech / A4-AISI 316
 Slotted vent / Grille d'aération

814074

Artikel-Nr. Item-no.	Ausführung Type	L	B	H	S	BD	Box	*€/Stück *€/piece
814074404	4 Schlitz / Slots	206	113	38	0,7	3,9	5	25,50
814074406	6 Schlitz / Slots	327	113	38	0,7	3,9	5	36,70
814074410	10 Schlitz / Slots	528	113	38	0,7	3,9	5	47,90

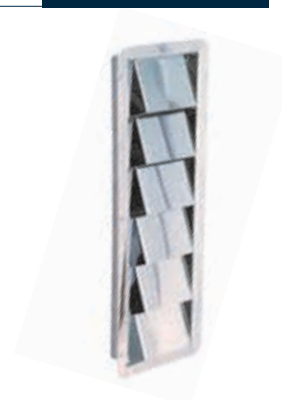
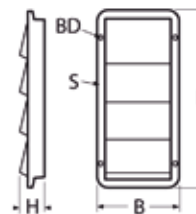

Deckslüfter mit Edelstahlkappe / A2-AISI 304 / Plastik
 Dome vent with stainless steel cap / Aérateur de pont avec couvercle à acier inox

8342

Artikel-Nr. Item-no.	D	iD	H	BD	Box	*€/Stück *€/piece
83422100	200	100	55	4	1	55,00

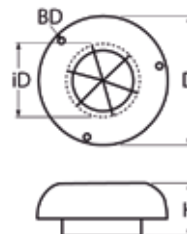

Deckslüfter mit Fenster / A2-AISI 304
 Dome vent with window / Aérateur de pont

8713

Artikel-Nr. Item-no.	D	iD	H	BD	Box	*€/Stück *€/piece
87132225	225	83	34	4	1	81,00

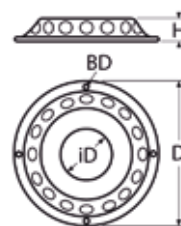

Lüfterhaube / A4-AISI 316 / PP
 Cowl vent / Aérateur scirocco

8657

Artikel-Nr. Item-no.	L	B	H	iD	BD	Box	*€/Stück *€/piece
86574125	130	147	48	72	4	1	34,60

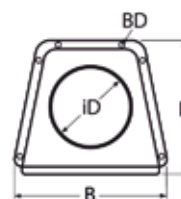

8

Yachtzubehör, Ausrüstung und Spezielles

Yachting accessories, equipment and highlights

Equipement et accessoires exclusifs pour yachts

8701

Pilzlüfter / A2-AISI 304 / Plastik
Mushroom vent / Aérateur avec fermeture

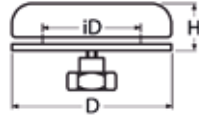
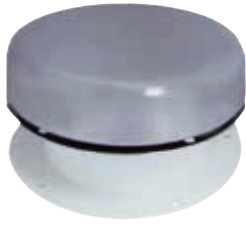

Artikel-Nr. Item-no.	D	iD	H	BD	Box	*€/Stück *€/piece
87012100	150	100	35	4,5	1	145,00

814918

Lüftungsblech, schwer / A4-AISI 316
Shell vent, heavy duty / Event de coquille, robuste

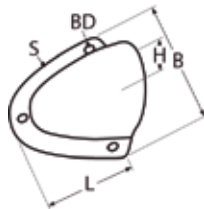

Artikel-Nr. Item-no.	L	B	H	S	BD	Box	*€/Stück *€/piece
814918264 66	64	66	17	1,5	4,2	10	16,30

8345

Lüftungsblech / A4-AISI 316
Shell vent / Event de coquille

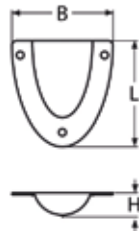

Artikel-Nr. Item-no.	B	L	H	Box	*€/Stück *€/piece
8345440 44 12	40	44	12	10	1,40
8345455 53 16	55	53	16	10	2,00

814933

Wasserauslass mit Edelstahlkappe / A4-AISI 316 / Nylon
Water drain with stainless steel cap / Sortie d'eau avec couvercle à acier inox



Artikel-Nr. Item-no.	Ausführung Type	Für Schlauch Ø For hose Ø	L	L1	B	T	iD	K	Box	*€/Stück *€/piece
8149334165STOPFEN	Mit Stopfen With plug	–	72	–	40	49	16,5	53	1	36,00
8149334165SCHLAUCH	Mit Schlauchanschluss With hose connector	19	116	30	40	49	–	53	1	36,00
NEW 8149334165	–	–	72	–	40	49	16,5	53	1	33,00

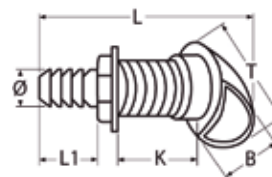
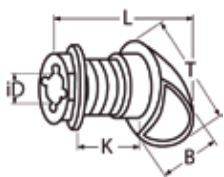



Tankentlüfter versenkt, 90° / A4-AISI 316
 Flush tank vent, 90° / Aération pour réservoir, fraisée, 90°

8894

Artikel-Nr. Item-no.	Für Schlauch-Ø For hose-Ø	L	B	D	D1	K	Box	*€/Stück *€/piece
8894416	16 (5/8")	70	75	46	35	15 - 31	1	53,10
8894419	19 (3/4")	76	80	49	38	15 - 31	1	60,80

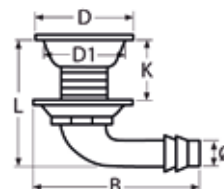

Tankentlüfter versenkt / A4-AISI 316
 Flush tank vent / Aération pour réservoir, fraisée

8895

Artikel-Nr. Item-no.	Für Schlauch-Ø For hose-Ø	L	D	D1	K	Box	*€/Stück *€/piece
8895416	16 (5/8")	76	46	35	15 - 35	1	50,70
8895419	19 (3/4")	78	49	38	15 - 35	1	53,30

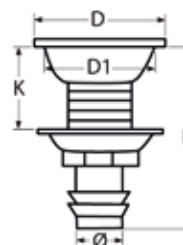

Tankentlüfter versenkt, 90° / A4-AISI 316
 Flush tank vent, 90° / Aération pour réservoir, fraisée, 90°

8861

Artikel-Nr. Item-no.	Für Schlauch-Ø For hose-Ø	L	B	D	Box	*€/Stück *€/piece
8861450	19 (3/4")	56	95	65	1	36,70

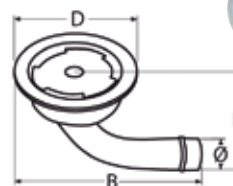

Tankentlüfter, 90° / A4-AISI 316
 Tank vent, 90° / Reniflard coudé

8319

Artikel-Nr. Item-no.	Für Schlauch-Ø For hose-Ø	L	B	D	K	GW	Box	*€/Stück *€/piece
8319416	16 (5/8")	85	60	31	17	3/4"	1	20,40
8319419	19 (3/4")	105	80	33	18	7/8"	1	35,00

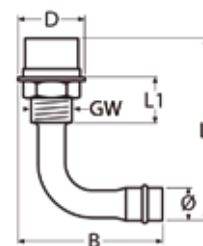

8

Yachtzubehör, Ausrüstung und Spezielles

Yachting accessories, equipment and highlights

Équipement et accessoires exclusifs pour yachts

8320

Tankentlüfter / A4-AISI 316

Tank vent / Aération pour réservoir

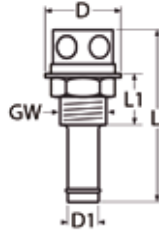

Artikel-Nr. Item-no.	Für Schlauch-Ø For hose-Ø	L	L1	D	GW	Box	*€/Stück *€/piece
8320416	16 (5/8")	70	13	31	3/4"	1	24,60
8320419	19 (3/4")	100	27	33	1"	1	44,10

815123

Tankentlüfter, flach / A4-AISI 316

Tank vent flat / Aération pour réservoir plat

NEW

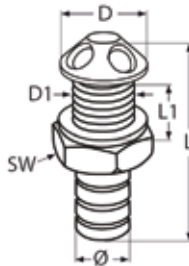

Artikel-Nr. Item-no.	Für Schlauch-Ø For hose-Ø	L	L1	D	Antrieb Drive	Box	*€/Stück *€/piece
815123419	19 (3/4")	71	27	29	SW22	1	37,50

814719

Tankentlüfter, 90° / Plastik

Tank vent, 90° / Aération pour réservoir, 90°

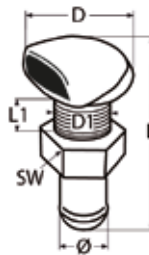

Artikel-Nr. Item-no.	Für Schlauch-Ø For hose-Ø	L	L1	D	D1	Antrieb Drive	Box	*€/Stück *€/piece
814719316	16 (5/8")	73	17	32	19	SW24	5	8,20

814720

Tankentlüfter / Plastik

Tank vent / Aération pour réservoir

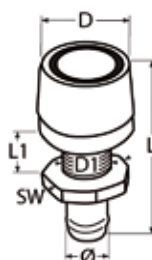

Artikel-Nr. Item-no.	Für Schlauch-Ø For hose-Ø	L	L1	D	D1	Antrieb Drive	Box	*€/Stück *€/piece
814720316	16 (5/8")	78	16	35	19	SW32	5	11,30

Yachtzubehör, Ausrüstung und Spezielles

Yachting accessories, equipment and highlights

Equipement et accessoires exclusifs pour yachts

8



Auspuffdurchlass / A4-AISI 316
Exhaust thru hull / Passe-coque d'échappement

815194

NEW

Artikel-Nr. Item-no.	Für Schlauch-Ø For hose-Ø	L	L1	D	D1	Box	*€/Stück *€/piece
81519443	76 (3")	131	33	118	88	1	400,00

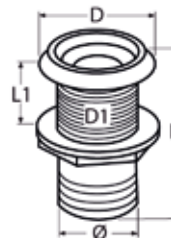

Einfüllstutzen mit versenkbarem Griff / A4-AISI 316
Hose deck fill with retractable handle / Nable de pont avec poignée rétractable

814929

Artikel-Nr. Item-no.	Für Schlauch-Ø For hose-Ø	Ausführung Type	L	L1	D	D1	Box	*€/Stück *€/piece
8149294DIESEL1 12	38 (1 1/2")	Diesel / Diesel	83	24	88	52	1	48,00
8149294GAS1 12	38 (1 1/2")	Benzin / Gas	83	24	88	52	1	48,00
8149294WATER1 12	38 (1 1/2")	Wasser / Water	83	24	88	52	1	48,00
8149294WASTE1 12	38 (1 1/2")	Abwasser / Waste	83	24	88	52	1	48,00
8149294DIESEL2	50 (2")	Diesel / Diesel	83	24	90	52	1	49,00
8149294GAS2	50 (2")	Benzin / Gas	83	24	90	52	1	49,00
8149294WATER2	50 (2")	Wasser / Water	83	24	90	52	1	49,00
8149294WASTE2	50 (2")	Abwasser / Waste	83	24	90	52	1	49,00

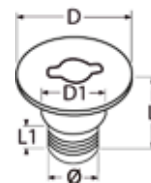

Einfüllstutzen mit Schlüssel / A4-AISI 316
Hose deck fill with key / Nable de pont avec clé

8314

Artikel-Nr. Item-no.	Für Schlauch-Ø For hose-Ø	Ausführung Type	L	L1	D	D2	BD	Box	*€/Stück *€/piece
83144DIESEL1 12	38 (1 1/2")	Diesel / Diesel	76	56	76	45	5	1	46,00
83144GAS1 12	38 (1 1/2")	Benzin / Gas	76	56	76	45	5	1	46,00
83144WATER1 12	38 (1 1/2")	Wasser / Water	76	56	76	45	5	1	46,00
83144WASTE1 12	38 (1 1/2")	Abwasser / Waste	76	56	76	45	5	1	46,00
83144DIESEL 2	50 (2")	Diesel / Diesel	76	56	84	54	5	1	54,00
83144GAS 2	50 (2")	Benzin / Gas	76	56	84	54	5	1	54,00
83144WASTE 2	50 (2")	Abwasser / Waste	76	56	84	54	5	1	54,00
83144SCHLUESSEL		Ersatzschlüssel / Replacement key							3,80
83144ERSATZ_D-G-W	38 (1 1/2")	Deckel und Kette Lid and chain					Diesel / Wasser / Gas Diesel / Water / Gas		14,00
83144ERSATZ_WASTE	38 (1 1/2")	Deckel / Lid					Abwasser / Waste		14,00
83144ERSATZ_D-G	50 (2")	Deckel ohne Kette Lid without chain					Benzin und Diesel Gas and Diesel		14,00

Ausführung "Abwasser" ohne Sicherungskette!
Type "Waste" without safety chain!
Version "eaux usées" sans chaîne de sécurité.

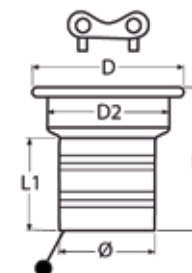

8

814930

Einfüllstutzen 30° mit versenkbarem Griff / A4-AISI 316

Hose deck fill 30° with retractable handle / Nable carburant coudée 30° ouverture avec bouchon a levier



Artikel-Nr. Item-no.	Für Schlauch-Ø For hose-Ø	Ausführung Type	L	L1	L2	D	D1	Box	*€/Stück *€/piece
8149304DIESEL1 12	38 (1 1/2")	Diesel / Diesel	97	24	31	82	45	1	50,00
8149304GAS1 12	38 (1 1/2")	Benzin / Gas	97	24	31	82	45	1	50,00
8149304WATER1 12	38 (1 1/2")	Wasser / Water	97	24	31	82	45	1	50,00
8149304WASTE1 12	38 (1 1/2")	Abwasser / Waste	97	24	31	82	45	1	50,00

814058

Einfüllstutzen Pop-up, mit Schloss / A4-AISI 316

Hose deck fill pop-up, with lock / Nable de pont rétractable avec serrure



Artikel-Nr. Item-no.	Für Schlauch-Ø For hose-Ø	Ausführung Type	L	D	D1	S	BD	Box	*€/Stück *€/piece
8140584G 2	50 (2")	Benzin / Gas	76	84	53	8	5	1	150,00
8140584W 2	50 (2")	Wasser / Water	76	84	53	8	5	1	150,00
814058SCHLUESSEL		Ersatzschlüssel / Replacement key						1	8,50

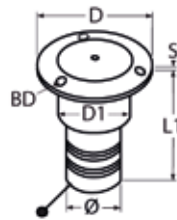

815153

Einfüllstutzen mit Schlitz, kurz / A4-AISI 316

Hose deck fill with slot, short / Nable de pont avec fente, court

NEW



Artikel-Nr. Item-no.	GW	Ausführung Type	L	L1	D	D1	Box	*€/Stück *€/piece
8151534W1 12	1 1/2"	Wasser / Water	50	22	98	53	1	67,00
8151534F1 12	1 1/2"	Kraftstoff / Fuel	50	22	98	53	1	67,00

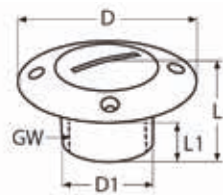

8835

Wasserablauf mit Gewinde / A4-AISI 316

Deck drain with thread / Evacuation d'eau avec filetage

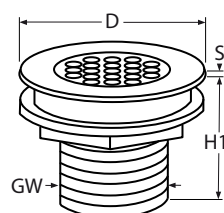

Artikel-Nr. Item-no.	GW	H1	D	S	Box	*€/Stück *€/piece
883541	1"	50	55	3	1	60,40
883541 12	1 1/2"	50	75	3	1	71,40

NEW

Cockpit-Abfluss / A4-AISI 316
 Cockpit drain / Vidange de cockpit

815162

Artikel-Nr. Item-no.	D	D1	H	Box	*€/Stück *€/piece
815162482	82	37	60	1	35,00

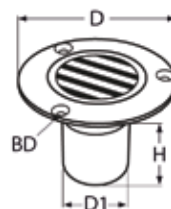

Wasserablauf mit Schlauchanschluss / A4-AISI 316
 Deck drain scupper with hose connection / Evacuation d'eau avec raccord de tuyau

814061

Artikel-Nr. Item-no.	Für Schlauch-Ø For hose-Ø	H1	D	D1	BD	Box	*€/Stück *€/piece
814061438 57	38 (1 1/2")	79	91	57	4,5	1	137,30
814061450 73	50 (2")	104	108	73	5,0	1	224,40
814061SCHLUESSEL		Schlüssel / Key				1	6,80

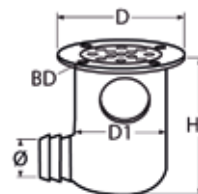

Schlüssel nicht inkl. / Key not incl. / Clé pas inclus.



Wasserablauf mit Schlauchanschluss / A4-AISI 316 / Nylon
 Deck drain scupper with hose connection / Evacuation pour Cockpit

814914

Artikel-Nr. Item-no.	Für Schlauch-Ø For hose-Ø	H	L	L1	D	D1	D2	Box	*€/Stück *€/piece
814914438	38 (1 1/2")	65	116	52	88	82	64	1	59,00
8149143STOPFEN		Stopfen / Plug						1	6,50

Schlüssel und Stopfen nicht inkl.
 Key and plug not incl.
 Clé et bouchon pas inclus.

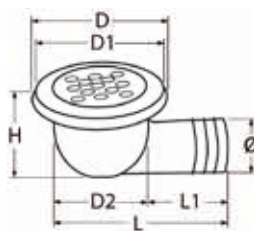

Wasserauslass / A4-AISI 316
 Water outlet / Sortie d'eau

814107



Artikel-Nr. Item-no.	Zoll Inch	D	D1	D2	H	BD	Box	*€/Stück *€/piece
814107470	3/4"	70	26	27	35	5	1	48,00

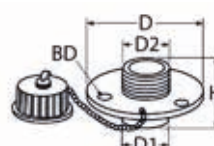

8

Yachtzubehör, Ausrüstung und Spezielles

Yachting accessories, equipment and highlights

Equipement et accessoires exclusifs pour yachts

814108

Wassereinlass / A4-AISI 316

Water inlet / Arrivée d'eau

 **MarineTown**

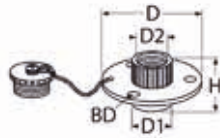

Artikel-Nr. Item-no.	Zoll Inch	D	D1	D2	H	BD	Box	*€/Stück *€/piece
814108470	3/4"	70	26	24	35	4,5	1	52,50

815192

Mini Wasserablauf / A2-AISI 304

Mini thru hull / Mini passe-coque

 **MarineTown**

NEW

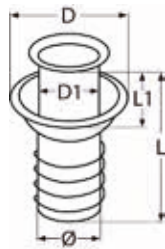

Artikel-Nr. Item-no.	Für Schlauch-Ø For hose-Ø	L	L1	D	D1	Box	*€/Stück *€/piece
815192238	10 (3/8")	36	Max. 9	13	8	1	13,00
815192212	13 (1/2")	36	Max. 9	16	10	1	14,00
815192258	16 (5/8")	39	Max. 9	19	13	1	15,00
815192234	19 (3/4")	44	Max. 9	22	16	1	16,00
81519221	25 (1")	44	Max. 9	29	22	1	19,00
81519221 18	28 (1 1/8")	80	Max. 41	35	25	1	20,00

814121

Cockpitdurchlass / A2-AISI 304

Cockpit drain scupper / Nable de cockpit

 **MarineTown**

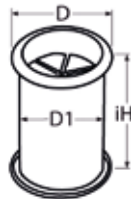

Artikel-Nr. Item-no.	D	D1	iH	Box	*€/Stück *€/piece
814121276	86	76	122	1	35,00

8421

Angelrutenhalter für Reling, verstellbar / A4-AISI 316

Adjustable fishing rod holder for rail / Support canne pour chandelier, adjustable

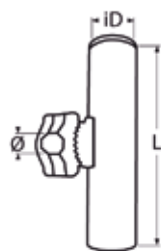

Artikel-Nr. Item-no.	Für Rohr-Ø For tube-Ø	L	iD	Box	*€/Stück *€/piece
8421422 25	22-25	230	40	1	76,60

Angelrutenhalter mit Grundplatte, verstellbar / A4-AISI 316
 Adjustable fishing rod holder with base plate / Support canne avec plaque, ajustable

814860

Artikel-Nr. Item-no.	L	L1	B	H	iD	BD	Box	*€/Stück *€/piece
8148604230	235	89	60	350	40	5,8	1	110,30

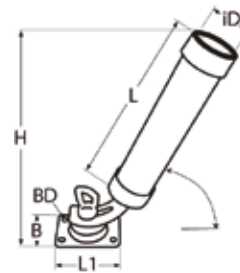

Angelrutenhalter für Reling, verstellbar / A4-AISI 316
 Adjustable fishing rod holder for rail / Support canne pour chandelier, ajustable

814861

Artikel-Nr. Item-no.	Für Rohr-Ø For tube-Ø	L	iD	Box	*€/Stück *€/piece
8148614285	30	285	40	1	110,40

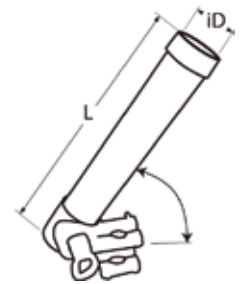

Angelrutenhalter mit Gummikappe / A2-AISI 304
 Fishing rod holder with rubber cap / Support canne avec couvercle en caoutchouc

8550

Artikel-Nr. Item-no.	L	L1	B	D	iD	S	BD	Box	*€/Stück *€/piece
85502245	245	115	90	51	40	6	8	1	28,00

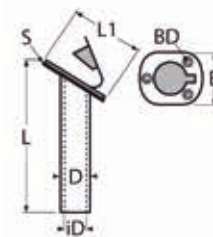

Angelrutenhalter mit Grundplatte, abnehmbar / A2-AISI 304
 Fishing rod holder with ground plate, removable / Support canne avec plaque, amovible

8718

Artikel-Nr. Item-no.	L	L1	B1	iD	BD	Box	*€/Stück *€/piece
8718250	240	100	93	40	7	1	48,30

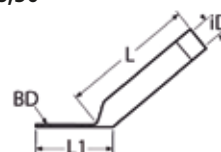

814957

Angelrutenhalter / Alu

Fishing rod storage rack / Support canne

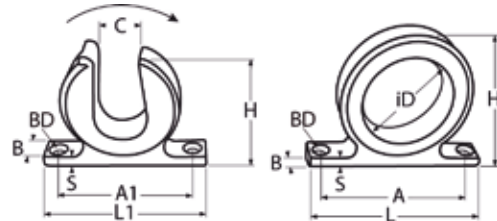

Artikel-Nr. Item-no.	L	L1	B	H	A	A1	C	iD	S	BD	Box	*€/Stück *€/piece
814957069	77,4	69	13	61,5	68	59	19,3	39	5	5	10	23,00

815062

Angelrutenhalter abschliessbar, MT-Serie / A4-AISI 316

Fishing rod storage rack lockable, MT-series / Porte-canne à pêche verrouillable, MT-série



NEW

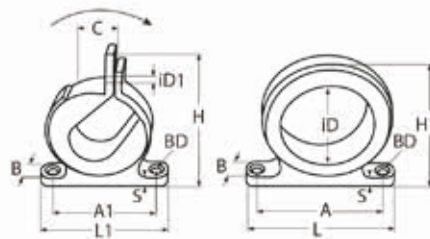

Artikel-Nr. Item-no.	L	L1	B	H	H1	A	A1	C	iD	iD1	S	BD	Box	*€/Stück *€/piece
8150624595	69	61	13	66,4	61,5	58	50	20	39,5	6	5	5	1	44,00

Wir empfehlen Vorhängeschloss 8500730. · Wie recommend padlock 8500730 · Nous recommandons cadenas 8500730

815076

Mastadapter für Angelrutenhalter / A4-AISI 316 / Nylon

Sunshade pole click adapter for rod holder / Crochet à dégagement rapide pour mât



NEW



Artikel-Nr. Item-no.	Für Rohr-Ø For tube-Ø	L	D	Box	*€/Stück *€/piece
815076422	22	175	38,4	1	85,00

Angelrutenhalter / Plastik
 Rod storage rack / Support canne

814054

Artikel-Nr. Item-no.	Ausführung Type	L	B	Box	*€/Stück *€/piece
8140543340 130VERT	Senkrecht / Vertical	340	130	1	15,50
8140543340 130HORIZ	Waagrecht / Horizontal	340	130	1	15,50

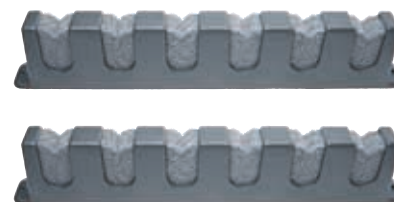

Antennenkipphalter auf Grundplatte / A4-AISI 316
 Adjustable antenna base / Support d'antenne inclinable sur plaque

8330

Artikel-Nr. Item-no.	GW	L	B	H	H1	BD	Box	*€/Stück *€/piece
8330492 64	1"	92	64	115	22	6,8	1	65,00
8330492 64 GD	–	92	64	Ersatz EPDM-Dichtung 2mm Replacement EPDM-sealing 2mm			1	3,00

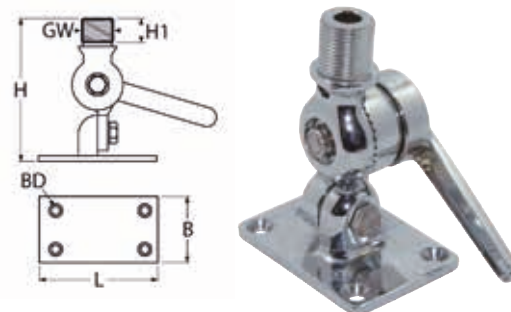

Antennenfuß mit Grundplatte / A4-AISI 316
 Antenna deck base / Embase d'antenne

8603

Artikel-Nr. Item-no.	GW	D	iD	H	H1	S	BD	Box	*€/Stück *€/piece
8603425	1"	70	18	40	30	5	7	1	28,00

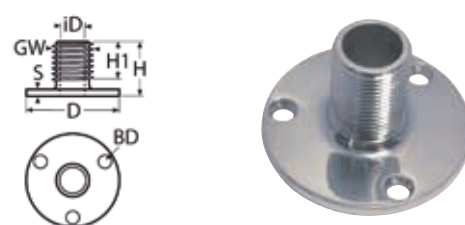

Antennenfuß mit Grundplatte, lang / A2-AISI 304
 Antenna deck base, long type / Embase d'antenne longue

8604

Artikel-Nr. Item-no.	GW	D	iD	H	H1	S	BD	Box	*€/Stück *€/piece
8604225	1"	70	18	105	22	3	7	1	28,40

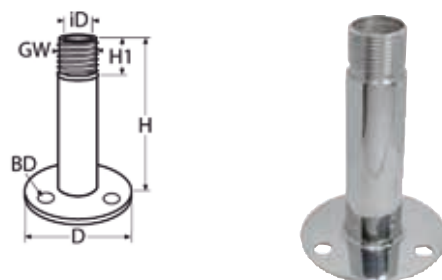

8720

Antennenfuß mit Rohraufnahme / A4-AISI 316

Antenna base for tube / Embase d'antenne pour tube



Artikel-Nr. Item-no.	GW	Für Rohr-Ø For tube-Ø	H	Box	*€/Stück *€/piece
8720425	1"	25	50	1	17,60

8332

Antennenkipphalter für Reling / A4-AISI 316

Adjustable antenna rail holder / Support d'antenne inclinable pour chandelier

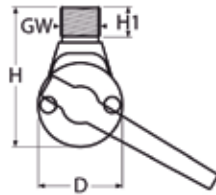

Artikel-Nr. Item-no.	GW	Für Rohr-Ø For tube-Ø	D	H	H1	Box	*€/Stück *€/piece
8332422/25	1"	22, 25	50	85	18	1	75,20

814113

Antennenhalter für Reling / A4-AISI 316

Antenna rail holder / Support d'antenne pour chandelier

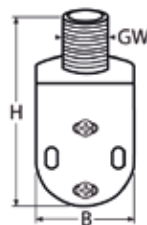

Artikel-Nr. Item-no.	GW	Für Rohr-Ø For tube-Ø	H	B	Box	*€/Stück *€/piece
81411342225	1"	22, 25	89	50	5	20,00

8244

Maststufe / A4-AISI 316

Mast step / Marche de mât

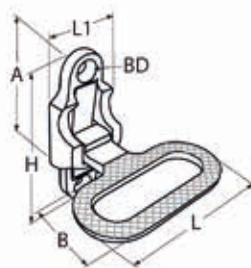

Artikel-Nr. Item-no.	L	L1	B	H	A	BD	Box	*€/Stück *€/piece
82444108 53	111	50	53	117	98	8,5	1	85,90



Antirutschplatte / A4-AISI 316
 Anti-slip step plate / Plaque antidérapante

814109

Artikel-Nr. Item-no.	L	B	S	BD	Box	*€/Stück *€/piece
8141094180	180	40	3,5	3,5	2	25,40

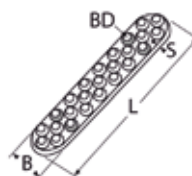

Radarreflektor zusammensteckbar / Alu
 Interlockable radar reflector / Réflecteur radar, accouplable

814149

Artikel-Nr. Item-no.	D	Box	*€/Stück *€/piece
814149041*	410	1	63,00
814149047	470	1	64,00



*Vorgeschrieben auf Regattayachten nach IOR.

*Mandatory on regatta yachts according to IOR regulations.

*Prescrit sur les voiliers de régates selon IOR.

Lukenversteller/ A2-AISI 304
 Hatch adjuster / Compas d'ouverture

8351

Artikel-Nr. Item-no.	L	L1	BD	Box	*€/Stück *€/piece
83512200 366	366	200	5,3	1	18,80
83512260 484	484	260	5,3	1	22,80

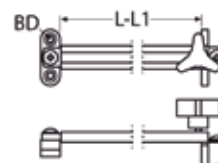

8472

Lukenfederhalter / A2-AISI 304

Hatch spring holder / Compas d'ouverture à ressort

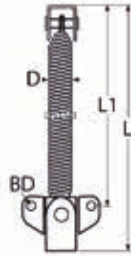

Artikel-Nr. Item-no.	L	L1	D	BD	Box	*€/Stück *€/piece
84722235	235	220	10	4	1	13,00
84722295	295	265	15	5	1	18,30

815195

Lukenverschluss mit Stellschraube / Messing vernickelt

Screw down hatch fastener, brass, chrome plated / Fermeture à vis de la trappe, laiton chromé



NEW

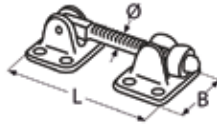

Artikel-Nr. Item-no.	ø	L	B	Box	*€/Stück *€/piece
815195793	9,5	93	40	2	31,00

8610

Tischplattenhalter, einsteckbar / A2-AISI 304

Attachable table bracket / Support de table, enfichable

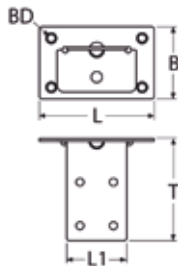

Artikel-Nr. Item-no.	L	L1	B	T	BD	Box	*€/Stück *€/piece
8610255 85	85	45	55	75	5,6	1	18,00

8522

Tischplattenhalter, klappbar / A2-AISI 304

Folding table bracket / Support de table, pliable

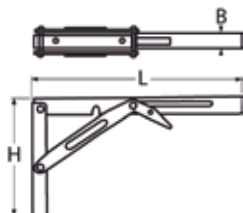

Artikel-Nr. Item-no.	L	B	H	Box	*€/Stück *€/piece
85222165 305	305	33	165	1	30,50

Belastbarkeit max.150kg
Max. load 150kg
Résistance max. 150kg.

Yachtzubehör, Ausrüstung und Spezielles

Yachting accessories, equipment and highlights
Equipement et accessoires exclusifs pour yachts

8

Türstopper / A4-AISI 316
Door stopper / Bloquer de porte

8477

Artikel-Nr. Item-no.	Ausführung Type	L	L1	D	BD	Box	*€/Stück *€/piece
8477460	Gerade / Straight	67	–	50	3,8	1	37,00
8477485	Gerade / Straight	85	–	50	3,8	1	40,00
8477495 90	90°	95	–	50	3,8	1	41,00
8477487 120	Variabel Variabel	120	87	50	5,1	1	48,00

NEW

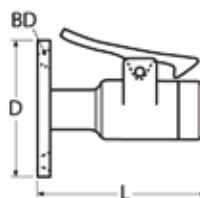

8477460

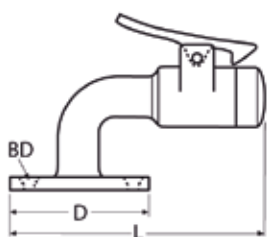

8477495 90

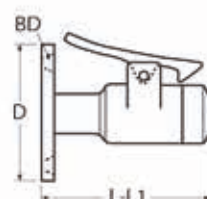

8477485

MarineTown

Türstopper / A4-AISI 316 / PVC
Doorstop / Bloquer de porte

814099

Artikel-Nr. Item-no.	L	B	A	D	BD	Box	*€/Stück *€/piece
814099470	70	48	30	12	5,5	5	21,30

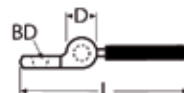

8

Türpuffer / A4-AISI 316
Door buffer / Butoir de porte

8520

Artikel-Nr. Item-no.	D	H	BD	Box	*€/Stück *€/piece
8520448	48	18	4,8	1	10,50



8592

Türklemme / A2-AISI 304

Door catch / Bloqueur de porte

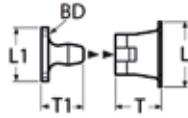

Artikel-Nr. Item-no.	L	L1	T	T1	BD	Box	*€/Stück *€/piece
8592229	34,0	31	26	22	4,3	5	30,50
8592241	40,5	41	31	70	4,3	5	38,00
8592242	41,0	42	31	40	4,3	5	39,00

8521

Kugelschnapper / A4-AISI 316

Ball catch / Bloqueur de porte à bille

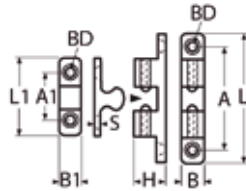

Artikel-Nr. Item-no.	L	L1	B	H	A	A1	S	BD	Box	*€/Stück *€/piece
852149 50	50	29	9	12	40	19	2,5	4	5	25,00

8825

Magnet-Türhalter schwenkbar, mit Einbauplatte / A4-AISI 316

Magnetic door holder with flush mount plate / Bloqueur de porte magnét., plaque de installation

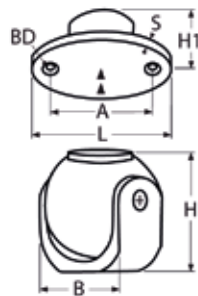

Artikel-Nr. Item-no.	L	B	H	H1	A	S	BD	Box	*€/Stück *€/piece
8825434 34	57	34	34	19	46	1,5	6,5	1	152,00

Magnetische Haltekraft ca. 5,8kg
Magnetic holding power ca. 5.8kg
Force de maintien magnétique env. 5,8kg.

814599

Magnet-Türhalter, schwenkbar, mit Aufbauplatte / A4-AISI 316

Swiveling magnetic door holder, with mount plate / Bloqueur de porte magnét. avec plaque de montage



Artikel-Nr. Item-no.	L	B	H	Box	*€/Stück *€/piece
814599434 34	70	34	34	1	180,30

Magnetische Haltekraft ca. 5,8kg
Magnetic holding power ca. 5.8kg
Force de maintien magnétique env. 5,8kg.

Yachtzubehör, Ausrüstung und Spezielles

Yachting accessories, equipment and highlights
Equipement et accessoires exclusifs pour yachts

8



Magnet-Türhalter, schwenkbar, mit Aufbauplatte / A4-AISI 316 / Nylon
Swiveling magnetic door holder, with mount plate / Bogueur de porte magnét. avec plaque de montage

814915

Artikel-Nr. Item-no.	L	L1	B	B1	A	A1	H	H1	BD	Box	*€/Stück *€/piece
814915435 29	44	53	29	14,5	33,5	38	35	14,5	6,1	1	74,00

Magnetische Haltekraft ca. 3,3kg
Magnetic holding power ca. 3.3kg
Force de maintien magnétique env. 3,3kg

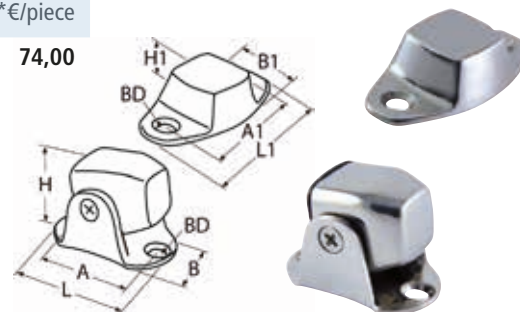

Magnet-Türhalter, justierbar, mit Einbauplatte / A4-AISI 316
Adjustable magnetic door holder, flush mount plate / Bogueur de porte magnét., plaque de installation

8826

Artikel-Nr. Item-no.	L	L1	D	D1	S	BD	Box	*€/Stück *€/piece
8826451	115	90	51	25	1	4,5	1	210,00

Magnetische Haltekraft ca. 6,5kg
Magnetic holding power ca. 6.5kg
Force de maintien magnétique env. 6,5kg

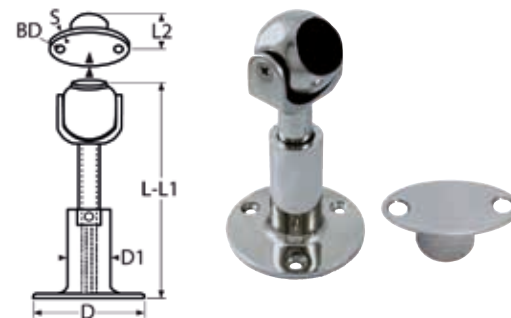

Magnet-Türhalter, justierbar, mit Aufbauplatte / A4-AISI 316
Adjustable magnetic door holder, with mount plate / Bogueur de porte magnét. avec plaque de montage

814598

Artikel-Nr. Item-no.	L	L1	L2	A	D	D1	BD	Box	*€/Stück *€/piece
814598460 89	115	90	19	56	51	25	4,5	1	228,00

Magnetische Haltekraft ca. 6,5kg
Magnetic holding power ca. 6.5kg
Force de maintien magnétique env. 6,5kg

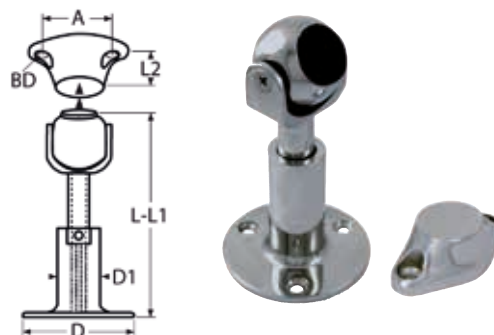

Magnet-Türstopper, schwenkbar, 90° / Messing verchromt

Foldable magnetic door-stop, 90° / Brass chromed / Bogueur de porte magnétique, orientable 90° / Laiton nickelé

814206

Artikel-Nr. Item-no.	L	L1	D	BD	Box	*€/Stück *€/piece
814206780	60	40	32	3,5	1	75,00

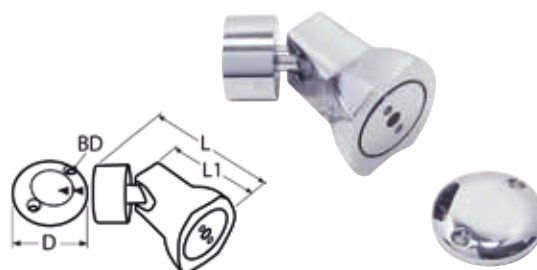

814682

Magnet-Türstopper / Messing verchromt

Magnetic door-stop / Brass chromed / Blogueur de porte magnétique / Laiton nickelé

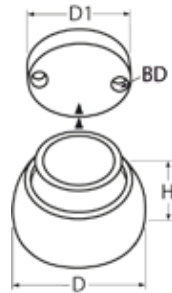

Artikel-Nr. Item-no.	D	D1	H	BD	Box	*€/Stück *€/piece
814682740	40	32	25	3,5	1	50,00

8591

Schloss mit Schlüssel / A2-AISI 304

Lock with key / Serrure avec clés

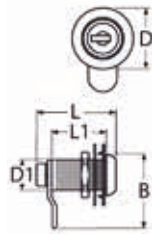

Artikel-Nr. Item-no.	L	L1	B	D	D1	Box	*€/Stück *€/piece
8591240	42	29	40	33	18	5	50,20

814093

Schlüsselanhänger Korkball

Key charm cork ball / Porte-clés balle en liège



Artikel-Nr. Item-no.	D	Box	*€/Stück *€/piece
8140933000	55	10	7,30

Schwimmfähig
Floatable
Flottable

8498

Vorhängeschloss, rund / A2-AISI 304

Round padlock / Cadenas rond



Artikel-Nr. Item-no.	D	iD	C	ø	Box	*€/Stück *€/piece
8498270	70	17,5	23	9,5	5	17,90

Inkl. 2 Schlüssel
2 keys incl.
Inclus 2 clés.

Yachtzubehör, Ausrüstung und Spezielles

Yachting accessories, equipment and highlights

Equipement et accessoires exclusifs pour yachts

8

Marine Vorhängeschloss / Messing verchromt / A2-AISI 304

Marine padlock, brass, chrome plated / Cadenas de marine en laiton chromé plaqué

8500

Artikel-Nr. Item-no.	L	B	iD	H1	ø	Box	*€/Stück *€/piece
8500730	30	12,7	15	27,3	4,8	5	24,00
8500740	40	14,2	22	33,0	6,4	5	35,00
8500750	50	16,5	27	40,3	7,9	5	46,00

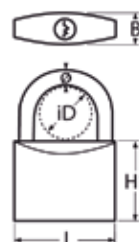

Inkl. 2 Schlüssel, Bügel Edelstahl A2, Korpus Messing verchromt, Innenteile Messing vernickelt. 240 Std. Salzsprühtest nach ASTM B117 bestanden.

2 keys incl., Shackle stainless steel AISI 304, Body Brass chromed, Inner parts brass nickel plated. Passed 240 hours salt spray test according to ASTM B117.

Inclus 2 clés., Etrier inox A2, corps laiton chromé, composants internes laiton nickelé. Test de brouillard salin réussi de 240 heures selon ASTM B117.



Deckel- oder Türverschluss / A4-AISI 316 / Plastik

Lid or door latch / Loquet de couvercle ou de porte

815008

Artikel-Nr. Item-no.	Ausführung Type	L	B	H	L1	B1	BD	Box	*€/Stück *€/piece
8150084111	Ohne Schloss Without lock	111	46	18	59	19	4,4	1	87,00
8150084111S	Mit Schloss With lock	111	46	18	59	19	4,4	1	101,00

Erforderliche Materialstärke für Einbau: 16mm (5/8"). Wir empfehlen Senkschrauben DIN 965 M4 oder Senk-Holzschrauben DIN 7997 4,0mm.

Minimum thickness of the door or latch: 16mm (5/8"). We recommend countersunk screws DIN 965 M4 or countersunk wood screws DIN 7997 4.0mm.

Épaisseur minimale de la porte ou du couvercle 16mm (5/8"). Nous recommandons des vis à tête fraisée DIN 965 M4 ou vis à bois à tête fraisée DIN 7997 4,0mm.

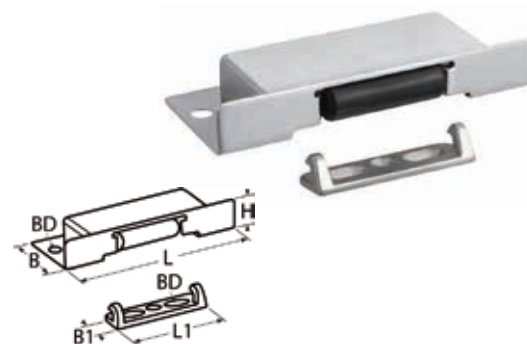

8

Türschloss, magnetisch / A4-AISI 316

Magnetic door latch / Serrure de porte, magnétique

8828

Artikel-Nr. Item-no.	K	L	D	H	H1	BD	Box	*€/Stück *€/piece
8828428 34	28 - 34	75	62	92	70	5,3	1	132,00

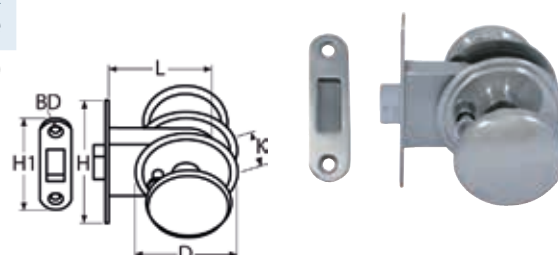

Yachtzubehör, Ausrüstung und Spezielles

Yachting accessories, equipment and highlights

Equipement et accessoires exclusifs pour yachts

814187

Druckknopfschloss / Plastik

Pushlock, plastic / Serrure à bouton-poussoir, en plastique

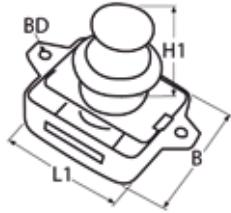

Artikel-Nr. Item-no.	L1	B	H1	BD	Box	*€/Stück *€/piece
8141873S	53	44	20	3	1	44,00

Für Türstärken max. 16mm inkl. Schliessblech

For door thickness max. 16mm incl. strike plate

Pour épaisseur de porte max. 16 mm. Inclus plaque de verrouillage.

814741

Druckknopfschloss / A4 / Nylon

Pushlock round / Serrure à bouton-pression

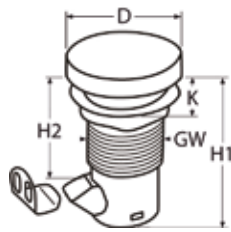

Artikel-Nr. Item-no.	D	H1	H2	K	GW	Box	*€/Stück *€/piece
814741236R	36	48	37	5-25	1"	1	26,90

8479

Harpunenspitze Delta Dreizack / A4-AISI 316

Trident fishhook delta / Embout d'harpon trident



Artikel-Nr. Item-no.	GW	L	Box	*€/Stück *€/piece
847946	M6	110	5	16,00

8480

Harpunenspitze, Dreizack / A4-AISI 316

Trident fishhook / Embout d'harpon triple



Artikel-Nr. Item-no.	GW	L	Box	*€/Stück *€/piece
848046	M6	125	5	20,50

Yachtzubehör, Ausrüstung und Spezielles

Yachting accessories, equipment and highlights
 Equipement et accessoires exclusifs pour yachts

8

Mini-Ruckdämpfer / Kautschuk

Mini-mooring compensator, EPDM rubber / Mini ressort de mouillage en caoutchouc

814155

NEW

Artikel-Nr. Item-no.	Für Seil-Ø For rope-Ø	L	Dehnung Strech	Box	*€/Stück *€/piece
814155310	6-10	150	100-150mm	4	12,90

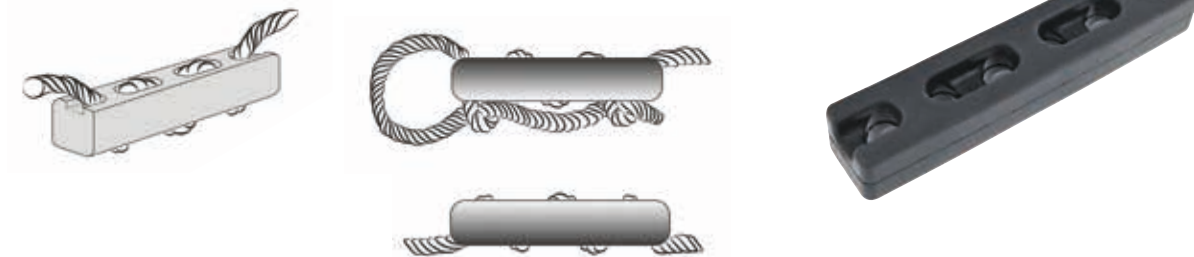

Ruckdämpfer / Kautschuk

Mooring compensator, EPDM rubber / Ressort de mouillage en caoutchouc

814156

Artikel-Nr. Item-no.	Für Seil-Ø For rope-Ø	L	Box	*€/Stück *€/piece
814156306	10-12	430	1	31,00
814156314	14-16	495	1	39,00
814156320	18-20	570	1	48,00



Technische Informationen
 Technical information
 Informations techniques

Ruckdämpfer / Anlegefeder / A2-AISI 304

Mooring spring / Ressort de mouillage

8377

Artikel-Nr. Item-no.	Ø	L	Max. Federkraft Max. spring force	Box	*€/Stück *€/piece
8377205 270	5	270	ca. 90kg	1	15,60
8377206 335	6	335	ca. 100kg	1	30,80
8377206 370	6	370	ca. 100kg	1	32,00
8377211 400	11	400	ca. 360kg	1	113,20

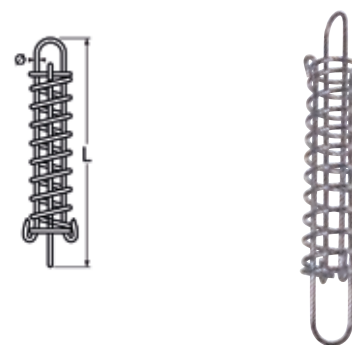

814862

Ruckdämpfer mit Gummi-Geräuschdämpfer / A4-AISI 316

Mooring spring with rubber silencer / Ressort de mouillage avec silencieux en caoutchouc



Artikel-Nr. Item-no.	ø	L	Box	*€/Stück *€/piece
814862405 300	5	300	1	29,60
814862406 300	6	300	1	41,30
814862409 470	9	470	1	112,00
814862411 470	11	470	1	137,30

8441

Abdeckkappe für Steckdose / A4-AISI 316

Cover for power socket / Couverture pour prise

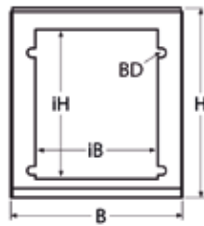

Artikel-Nr. Item-no.	B	iB	H	iH	BD	Box	*€/Stück *€/piece
84414115 125	115	81	125	100	5,5	1	59,00

814136

Getränkehalter mit Edelstahlabdeckung, klappbar / A2-AISI 304

Foldable drink holder with stainless steel cover / Porte-gobelet avec couvercle en inox, pliable



Artikel-Nr. Item-no.	Farbe Colour	B	T	H	iD	BD	Box	*€/Stück *€/piece
8141362W	Weiß / White	95	93	92	70	6,5	2	44,00
8141362B	Schwarz / Black	95	93	92	70	6,5	2	44,00

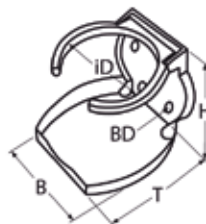

NEW

Getränkehalter für Reling, klappbar / A4-AISI 316
 Foldable drink holder for rail / Porte-gobelet pour garde-corps, pliable

815085

Artikel-Nr. Item-no.	Für Rohr-Ø For tube-Ø	B	T	H	iD	Box	*€/Stück *€/piece
815085497 105	22-30	97	105	100	90	1	90,00

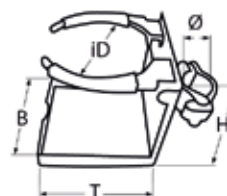

Getränkehalter / A2-AISI 304
 Drink holder / Porte-gobelet

814135

Artikel-Nr. Item-no.	Ausführung Type	L	H	H1	iD	A	GW	Box	*€/Stück *€/piece
81413522	Doppelt / Double	210	100	51	88	205	8	2	46,00
81413523	Dreifach / Triple	310	100	51	88	105	8	2	55,00

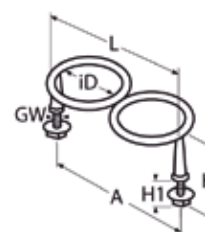

Getränkehalter für Einbau / A2-AISI 304
 Drink holder for installation / Porte-gobelet pour installation

8832

Artikel-Nr. Item-no.	D	D1	iD	H	S	Box	*€/Stück *€/piece
88322109	109	95	94	83	3	1	44,00

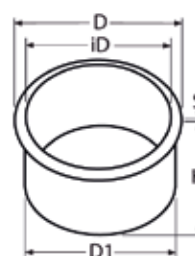

Flaschenhalter für Wandmontage / A2-AISI 304
 Bottle holder for wall mount / Porte-boisson pour montage

8525

Artikel-Nr. Item-no.	iD	H	T	Box	*€/Stück *€/piece
85252140	100	120	140	1	22,90

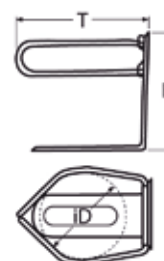

8

Yachtzubehör, Ausrüstung und Spezielles

Yachting accessories, equipment and highlights

Equipement et accessoires exclusifs pour yachts

8355

Flaschenhalter für Reling / A2-AISI 304

Bottle holder for rail / Porte-boisson pour chandelier



Artikel-Nr. Item-no.	H	iD	Box	*€/Stück *€/piece
8355274	260	74	1	13,60

815084

Angelrutenhalter für Reling, leichte Ausführung / A4-AISI 316

Fishing rod holder for rail, light type / Porte-canne à pêche pour garde-corps, version légère

NEW



Artikel-Nr. Item-no.	Für Rohr-Ø For tube-Ø	L	iD	Box	*€/Stück *€/piece
8150844190	22-30	190	35	1	58,00

814842

Sportflasche mit Alu-Karabiner / Edelstahl

Sport bottle with alu-spring hook stainless steel - Stainless steel / Bouteille de sport avec mousqueton en alu - Acier inox



Artikel-Nr. Item-no.	Ausführung Type	Box	*€/Stück *€/piece
8148422075	0,75L	1	18,00

8937

Isolierbecher mit Deckel, mattiert / Edelstahl

Vacuum mug with lid, brushed - Stainless steel / Gobelet isolant avec couvercle, mat - Acier inox



Artikel-Nr. Item-no.	Ausführung Type	Box	*€/Stück *€/piece
89372035	0,35L	1	18,50

Doppelwandig
Double walled
Double paroi

Yachtzubehör, Ausrüstung und Spezielles

Yachting accessories, equipment and highlights
Equipement et accessoires exclusifs pour yachts

8

Isolierbecher, mattiert / Edelstahl

Vacuum mug, brushed - Stainless steel / Gobelet isolant, mat - Acier inox

8938

Artikel-Nr. Item-no.	Ausführung Type	Box	*€/Stück *€/piece
89382030	0,3L	1	18,50

Doppelwandig
Double walled
Double paroi



Flachmann "Skippers friend" / Edelstahl

Pocket bottle "Skippers friend" - Stainless steel / Flasque "Skippers friend" - Acier inox

814759

Artikel-Nr. Item-no.	Ausführung Type	Box	*€/Stück *€/piece
8147592190	190ml	1	14,20



Cappuccino Becher, hochglanzpoliert / Edelstahl

Cappuccino cup, mirror polished - Stainless steel / Gobelet cappuccino, poli-miroir - Acier inox

8941

Artikel-Nr. Item-no.	Ausführung Type	Box	*€/Stück *€/piece
89412030	0,3L	1	17,60

Doppelwandig
Double walled
Double paroi



Teleskop-Bootshaken / Alu / Plastik

Telescopic-boat hook / Gaffe télescopique

814280

Artikel-Nr. Item-no.	Farbe Colour	L	L1	D	Box	*€/Stück *€/piece
81428005	Silber / Silver / Argent	2100	1200	30	1	29,30

Stufenlos verstellbar
Infinitely adjustable
Réglable en continu

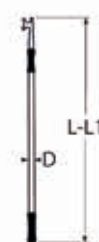

8

814281

Holz-Bootshaken mit Edelstahlhaken / A2-AISI 304

Wooden boat hook with stainless steel hook / Gaffe en bois avec crochet en inox



Artikel-Nr. Item-no.	L	D	Box	*€/Stück *€/piece
8142812180	1800	28	1	94,60
8142812210	2100	28	1	96,00

Hergestellt aus Buchenholz

Made of beech wood

Fabriqué en bois de hêtre

814947

Bootshaken-Spitze / A4-AISI 316

Boat hook tip / Pointe de gaffe

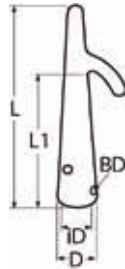

Artikel-Nr. Item-no.	L	L1	D	iD	BD	Box	*€/Stück *€/piece
8149474190	190	105	38,5	30	4,8	1	37,30

8523

Spiralhaken für Segelzeising / A2-AISI 304

Shock cord hook for sail tie / Crochet de sandow

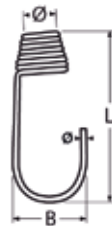

Artikel-Nr. Item-no.	Für Seil-Ø For rope-Ø	L	B	Ø	Box	*€/Stück *€/piece
8523206	6	50	20	1,8	20	1,50
8523208	8	70	27	2,4	20	1,70
8523210	10	77	28	2,4	20	2,30

8708

Segelzeising mit Spiralhaken / A2-AISI 304

Sail tie with shock cord hooks / Sandow avec crochets



Artikel-Nr. Item-no.	Ø	L	Box	*€/Stück *€/piece
870820500	8	700	10	6,30
870821000	8	1200	10	8,40

Yachtzubehör, Ausrüstung und Spezielles

Yachting accessories, equipment and highlights
Equipement et accessoires exclusifs pour yachts

8

Lenzstopfen, rund / A4-AISI 316

Drain plug, round / Bouchon de nable à visser, rond

8700

Artikel-Nr. Item-no.	D	D1	H	BD	Antrieb Drive	Box	*€/Stück *€/piece
8700426 16	50	20	16	4,2	SW14	1	18,30

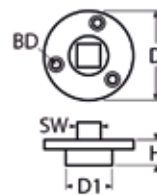

Lenzstopfen mit Kipphebel / A2-AISI 304

Drain plug with snap handle / Bouchon avec culbuteur

8596

Artikel-Nr. Item-no.	L	L1	D	D1	Box	*€/Stück *€/piece
8596225	50	33	22	25	1	6,60



Lenzstopfen, oval / A4-AISI 316 / Nylon

Drain plug, oval / Bouchon de nable à visser, ovale

8669

Artikel-Nr. Item-no.	L	B	D	BD	Box	*€/Stück *€/piece
8669439	51	38	24	5	1	11,00

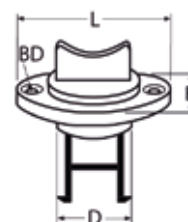

Lenzstopfen, oval / A4-AISI 316

Drain plug, oval / Bouchon de nable à visser, ovale

814120

Artikel-Nr. Item-no.	L	B	D	BD	Box	*€/Stück *€/piece
814120454	54	39	24	5	2	38,10
814120464	64	48	31	5	2	40,00

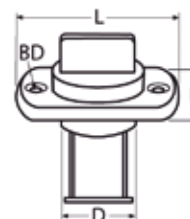

Wir empfehlen Senkschrauben DIN 965 M4 oder Senk-Holzschrauben DIN 7997 4,0mm.
We recommend countersunk screws DIN 965 M4 or countersunk wood screws DIN 7997 4.0mm.
Nous recommandons des vis à tête fraisée DIN 965 M4 ou vis à bois à tête fraisée DIN 7997 4,0mm.

8

Yachtzubehör, Ausrüstung und Spezielles

Yachting accessories, equipment and highlights

Equipement et accessoires exclusifs pour yachts

8880

Kielrolle mit Buchse / Gummi / Plastik

Keel roller with shaft - Rubber / Plastic / Diabolo de quille avec connecteur - Caoutchouc / Plastique

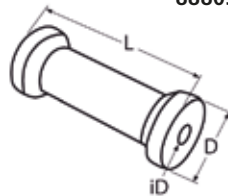

Artikel-Nr. Item-no.	L	D	iD	Box	*€/Stück *€/piece
88803100	100	75	13	5	5,90
88803130	130	75	16	5	8,00
88803200	190	75	16	5	10,40

8881

Bugrolle / Gummi

Bow roller - Rubber / Diabolo - Caoutchouc

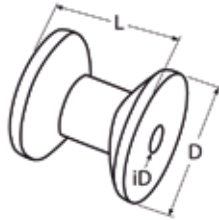

Artikel-Nr. Item-no.	L	D	iD	Box	*€/Stück *€/piece
88813075	75	75	13	5	7,00

8882

V-Kielrolle mit Buchse / Gummi / Plastik

V-keel roller with shaft - Rubber / Plastic / Diabolo de quille en V avec connecteur - Caoutchouc / Plastique

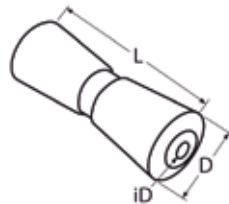

Artikel-Nr. Item-no.	L	D	iD	Box	*€/Stück *€/piece
88823200	180	80	16	5	13,60
88823250	230	80	16	5	17,90

8883

Seitenrolle mit Buchse / Gummi / Plastik

Side guide roller with shaft - Rubber / Plastic / Rouleau avec connecteur - Caoutchouc / Plastique

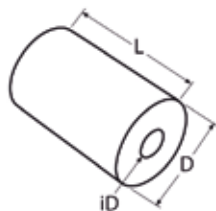

Artikel-Nr. Item-no.	L	D	iD	Box	*€/Stück *€/piece
88833100	100	62	16	5	9,60
88833150	150	62	16	5	11,10

Yachtzubehör, Ausrüstung und Spezielles

Yachting accessories, equipment and highlights
 Equipement et accessoires exclusifs pour yachts

8

Bugpuffer / Gummi

Bow guard - Rubber / Patin d'étrave - Caoutchouc

8884

Artikel-Nr. Item-no.	L1	B	H	Box	*€/Stück *€/piece
88843050	50	50	50	5	6,00
88843100	100	75	80	5	13,40

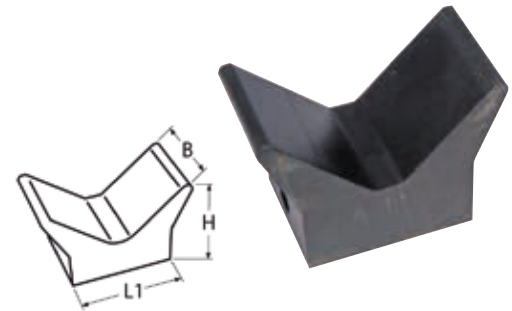

Lichtmast / A2-AISI 304

Lamp post / Support de lumière pour mât

814092

Artikel-Nr. Item-no.	H	H1	B	BD	Box	*€/Stück *€/piece
8140922730	730	460	350	7,8	1	158,00

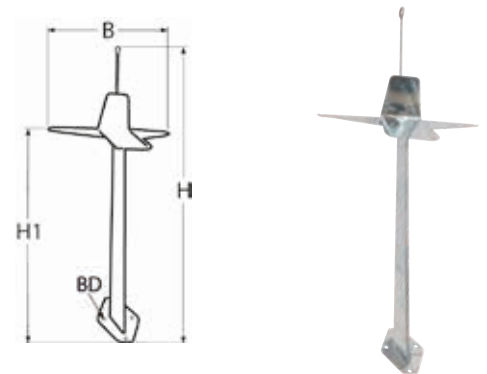

Schleusenhooken / A4-AISI 316

Sluice hook / Crochet d'écluse

8998

Artikel-Nr. Item-no.	L	iD	ø	Box	*€/Stück *€/piece
89984245 10	245	22	10	5	10,00

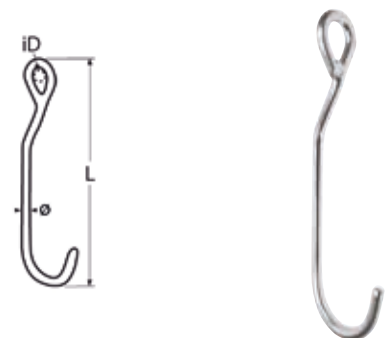

Schleusenhooken mit Triangel-Griff / A4-AISI 316

Sluice hook with triangle handle / Crochet d'écluse avec poignée triangulaire

814126

Artikel-Nr. Item-no.	L	iB	C	ø	Box	*€/Stück *€/piece
8141264560 10	525	116	49	10	2	20,20
8141264750 10	750	116	49	10	2	28,40

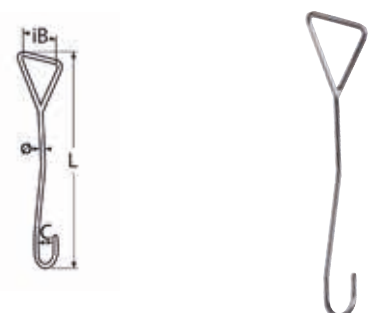

814127

Bojenhaken / A4-AISI 316

Buoy hook / Crochet de bouée



Artikel-Nr. Item-no.	L	iB	C	ø	Box	*€/Stück *€/piece
8141274116 10	1160	30	38	10	2	52,40

814688

Bojenhaken mit Sicherung / A4-AISI 316

Buoy hook with safety lock / Longe de sécurité



Artikel-Nr. Item-no.	L	D	C	Box	*€/Stück *€/piece
8146884900	900	25	30	1	115,00
81468841400	1400	30	40	1	128,60

814151

Winschkurbel, schwimmfähig / Plastik

Floating winch handle - Plastic / Manivelle de winch, flottante - Plastique



Artikel-Nr. Item-no.	L	Box	*€/Stück *€/piece
8141513250	250	2	41,00

814152

Winschkurbel / Alu

Winch handle / Manivelle de winch

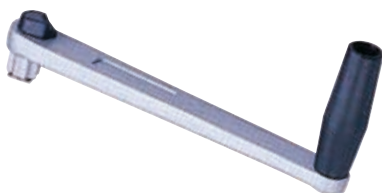

Artikel-Nr. Item-no.	L	Box	*€/Stück *€/piece
8141520250	250	2	62,40

Wäscheleine, ausziehbar / A2-AISI 304
 Clothesline with pull out / Corde à linge, extensible

814692

Artikel-Nr. Item-no.	L	D	BD	Box	*€/Stück *€/piece
814692290	2500	90	3,9	1	12,30



Lenkradknopf / A4-AISI 316
 Control knob / Poignée de volant

814098

Artikel-Nr. Item-no.	Für Rohr-Ø For tube-Ø	Box	*€/Stück *€/piece
814098420	20	1	31,60



Manuelle Trailerwinde / A2-AISI 304
 Manual winch / Treuil manuel

814129

Artikel-Nr. Item-no.	L1	B1	Box	*€/Stück *€/piece
8141292270	109	89	1	300,00
8141292540	137	89	1	420,00

8141292270: Übersetzung 3:1 / max. Zugkraft 270kg
 Gear ratio 3:1 / max. traction 270kg
 Rapport de démultiplication 3:1 / max. traction 270kg

8141292540: Übersetzung 4,1:1 / max. Zugkraft 545kg
 Gear ratio 4,1:1 / max. traction 545kg
 Rapport de démultiplication 4,1:1 / max. traction 545kg



marinotech.shop
 Technische Zeichnung
 Technical drawing
 Dessin technique



8

Wasserskihaken für Heckspiegel / A4-AISI 316
 Transom waterski tow eye hook / Crochet pour ski-nautique et tableau arrière

8559

Artikel-Nr. Item-no.	ø	GW	T	T1	D	Antrieb Drive	Box	*€/Stück *€/piece
85594100 60	9	M10	100	60	60	SW14	1	64,80
85594125 90	12	M12	125	75	90	SW19	1	88,80

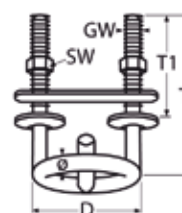

8891

Wasserskihaken für Heckspiegel / A4-AISI 316

Transom waterski tow eye hook / Crochet pour ski-nautique et tableau arrière

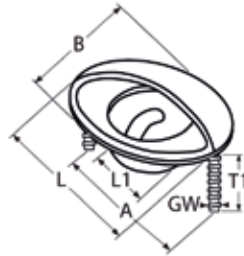

Artikel-Nr. Item-no.	L	L1	B	GW	A	T1	Box	*€/Stück *€/piece
8891492 62	92	50	62	M8	73,5	47	1	59,00

816016

Pop-Out Wasserskiklampe / A4-AISI 316

Pop-out ski tow cleat / Taquet de remorquage de ski escamotable



NEW

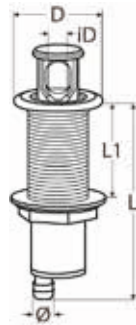

Artikel-Nr. Item-no.	ø	L	L1	D	iD	Box	*€/Stück *€/piece
816016415	16	146	73	68	15	1	254,00

8706

Außenborderhalterung mit Neigungsverstellung / A2-AISI 304 / Plastik

Adjustable outbord motor bracket / Support de moteur hors-bord avec inclinaison

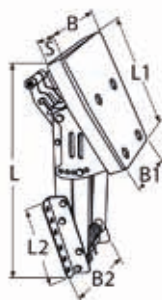

Artikel-Nr. Item-no.	L	L1	L2	B	B1	B2	S	Box	*€/Stück *€/piece
8706220	520	260	200	210	160	190	44	1	352,20

Max. Belastung 40kg

Max. load 40kg

Charge max. 40kg

8934

Außenborderhalterung mit Holzplatte / A2-AISI 304

Outboard motor bracket with wood plate / Support de moteur hors-bord avec plaque en bois

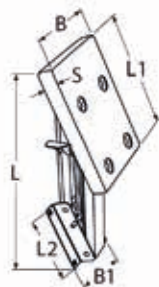

Artikel-Nr. Item-no.	L	L1	L2	B	B1	S	Box	*€/Stück *€/piece
8934210	450	245	145	180	115	35	1	144,00

Max. Belastung 30kg

Max. load 30kg

Charge max. 30kg

Yachtzubehör, Ausrüstung und Spezielles

Yachting accessories, equipment and highlights

Equipement et accessoires exclusifs pour yachts

8

Außenborderhalterung mit Kunststoffplatte / A2-AISI 304 / Plastik

Outboard motor bracket with plastic plate / Support de moteur hors-bord avec plaque plastique

814596

Artikel-Nr. Item-no.	L	L1	L2	B	B1	B2	S	Box	*€/Stück *€/piece
814596210	490	265	145	208	160	110	44	1	152,20

Max. Belastung 30kg
Max. load 30kg
Charge max. 30kg

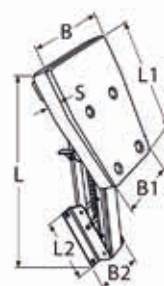

Propeller-Schutzhülle für Außenborder / Polyester-Terylene

Propeller cover for outboard motor - Polyester / Houssé de protection pour propulseur - Polyester

814590

Artikel-Nr. Item-no.	Farbe Colour	L	B	H	Box	*€/Stück *€/piece
8145903560	Rot / Red / Rouge	560	660	260	1	51,20

100% wasserabweisend UV-beständig Das Abdecken des Propellers während des Transports ist in Deutschland nach StVO §32 Abs.2 pflicht, sofern er über die Lichtleiste ragt.

100% water-repellent UV-resistant Covering the propeller during transport is mandatory in Germany according to StVO §32 Abs.2 if it is above the light bar.

100 % étanche. Résistant aux UV. Le recouvrement de l'hélice pendant le transport est obligatoire en Allemagne selon StVO §32 Abs. 2, si elle dépasse de la rampe lumineuse.



Außenborderschloss / A4-AISI 316

Outboard engine lock / Serrure pour moteur hors-bord

8554

Artikel-Nr. Item-no.	L	B	H	Box	*€/Stück *€/piece
85544270	305	40	40	1	88,00

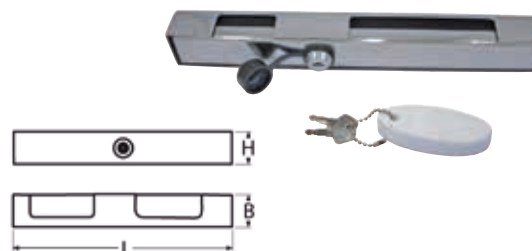

Verlängerungsgasgriff für Außenborder / Alu

Telescopic outboard motor handle / Rallonge de barre franche télescopique pour moteur

814282

Artikel-Nr. Item-no.	L	L1	Box	*€/Stück *€/piece
8142820600	1000	600	1	47,40

Mit Not-Stop Funktion.
With kill switch.
Avec fonction d'arrêt d'urgence.

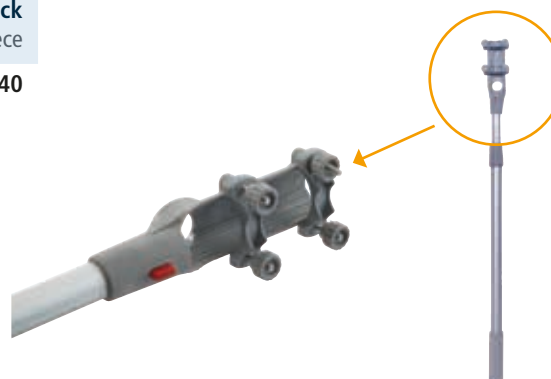

816004

Transporttrolley für Außenborder, faltbar / Alu
 Motor trolley, foldable / Chariot transport pour moteur hors-bord

NEW

Artikel-Nr. Item-no.	Box	*€/Stück *€/piece
816004060	1	199,00

Neue, verbesserte Version komplett gefertigt aus Aluminium. Gewicht nur 4,3 kg.

Keine Schweißnähte. Maximale Belastung 60 kg.

New improved version. Completely made of aluminum. Weight only 4,3 kg. No welding. Maximum load 60 kg.

Version optimisée entièrement en aluminium (poids seulement 4,3kg). Pas de soudures. Charge maximale 60 kg.



Technische Informationen
 Technical information
 Informations techniques

814289

Motordruckplatte für Heckspiegel / Plastik
 Motor transom plate / Plaque de moteur pour tableau arrière

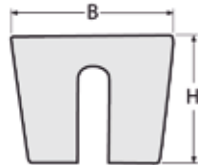

Artikel-Nr. Item-no.	B	H	Box	*€/Stück *€/piece
8142893430 350	430	350	5	9,50

814290

Motordruckplatte für Heckspiegel, 4° geneigt / Plastik
 Motor transom plate, 4° inclined / Plaque de moteur pour tableau arrière, incliné 4°

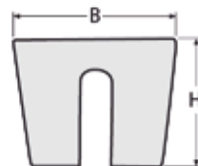

Artikel-Nr. Item-no.	B	H	Box	*€/Stück *€/piece
8142903420 340	420	340	5	14,40

Yachtzubehör, Ausrüstung und Spezielles

Yachting accessories, equipment and highlights
 Equipement et accessoires exclusifs pour yachts

8

Bugsprriet Holz / A4-AISI 316
 Bow spring wood / Delphinrière bois

814647

Artikel-Nr. Item-no.	L	B	B1	Box	*€/Stück *€/piece
8146474280	650	330	280	1	400,00

Holzart: White tulip oak

Wood type: White tulip oak

Type de bois: Chêne tulip blanche

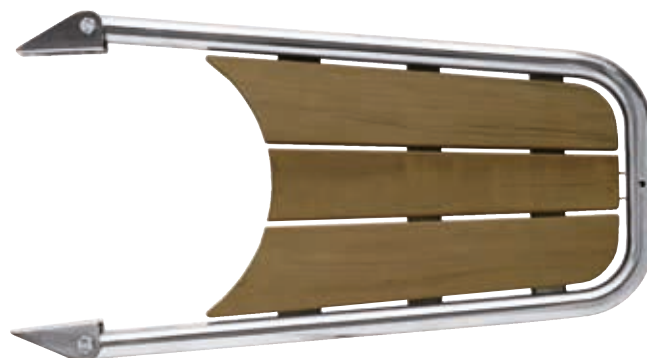
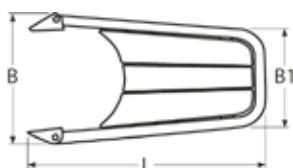

Aufsteller für Abdeckplane / Alu
 Pole for boat cover / Barre extensible pour bâche

814265

Artikel-Nr. Item-no.	L	L1	Box	*€/Stück *€/piece
8142650600 1000	1000	600	1	23,30
8142650900 1500	1500	900	1	25,00



8



Produkte für die Schifffahrtsindustrie – „We produce boat jewelry“

Marine Town wurde 1988 gegründet und ist ein professioneller Hersteller von Schiffsbeschlägen aus rostfreiem Stahl. Mit globalen Aktivitäten in Asien und Amerika baut die Marine Town Gruppe nicht nur eine zuverlässige, sondern auch eine nachhaltige Lieferkette auf, die ihren Handelspartnern weltweit einen außergewöhnlichen Service bietet.

Im Laufe der Jahre hat Marine Town mit führenden Bootsherstellern in den USA zusammengearbeitet, um viele patentierte, innovative und hochwertige Produkte zu entwickeln. Wenn die Produkte den endgültigen Bestimmungsort erreichen, haben sie umfangreiche Tests und Kontrollen durchlaufen, um zu garantieren, dass Sie mehr als nur Hardware erhalten. Mit dem Kernwert „Innovation, Qualität und Service“ heben die einzigartigen Produkte von Marine Town den Standard der Bootsindustrie auf die nächste Stufe.



MAGNETIC
FLUX TEST



RUBBER HARDNESS
TEST



MATERIAL
ANALYSIS



SALT SPRAY
TEST



AUTOMATIC
PROCESSING



THREAD
GAUGE



WELDING



BREAKING
TEST





Products for the marine industry – "We produce boat jewelry"

Marine Town, established in 1988, is a **professional stainless steel marine hardware manufacturer**. With global operations spanning Asia and America, the Marine Town group builds not only a reliable but sustainable supply chain providing exceptional service to its trade partners worldwide. Over the years, Marine Town has collaborated with top boat manufacturers in the USA to design **many patented, innovative, and quality products**. By the time the products reach the final destination, they have undergone extensive testing and inspection to guarantee that you receive more than just hardware. With the core value, "Innovation, Quality, and Service, Marine Town's unique products push the standard of the marine industry to the next level.



Produits pour l'industrie maritime – «We produce boat jewelry»

Marine Town, établi en 1988, est un **fabricant professionnel de matériel marin en acier inoxydable**. Avec des opérations mondiales s'étendant de l'Asie à l'Amérique, le groupe Marine Town construit une chaîne d'approvisionnement non seulement fiable mais durable fournissant un service exceptionnel à ses partenaires commerciaux dans le monde entier. Au fil des ans, Marine Town a collaboré avec les principaux fabricants de bateaux aux États-Unis pour concevoir **de nombreux produits brevetés, innovants et de qualité**. Au moment où les produits atteignent la destination finale, ils ont subi des tests et des inspections approfondis pour garantir que vous recevez plus que du matériel.



Productos para la industria naval – «We produce boat jewelry»

Marine Town, fundada en 1988, es un **fabricante profesional de herrajes marinos de acero inoxidable**. Con operaciones globales que abarcan Asia y América, el grupo Marine Town construye no sólo una cadena de suministro fiable, sino también sostenible, proporcionando un servicio excepcional a sus socios comerciales en todo el mundo. A lo largo de los años, Marine Town ha colaborado con los principales fabricantes de embarcaciones de Estados Unidos para diseñar **numerosos productos patentados, innovadores y de calidad**. En el momento en que los productos llegan a su destino final, han sido sometidos a exhaustivas pruebas e inspecciones para garantizar que usted reciba algo más que simple hardware.



Produkty dla przemysłu morskiego – „We produce boat jewelry”

Marine Town, założone w 1988 roku, jest **profesjonalnym producentem okuć morskich ze stali nierdzewnej**. Z globalnymi operacjami obejmującymi Azję i Amerykę, grupa Marine Town buduje nie tylko niezawodny ale i zrównoważony łańcuch dostaw zapewniając wyjątkowe usługi dla swoich partnerów handlowych na całym świecie. Na przestrzeni lat, Marine Town współpracowała z najlepszymi producentami łodzi w USA, aby zaprojektować **wiele opatentowanych, innowacyjnych i wysokiej jakości produktów**. Zanim produkty dotarły do miejsca przeznaczenia, zostały poddane szczegółowym testom i inspekcjom, aby zagwarantować, że otrzymują Państwo coś więcej niż tylko sprzęt.

815072

Sonnensegelmast "Carbon" / A4-AISI 316 / GFK
Sunshade pole „Carbon“ / Mât pour auvent „Carbone“
 MarineTown

NEW



Artikel-Nr. Item-no.	L	L1	D	D1	D2	C	Box	*€/Stück *€/piece
81507241215	1215	75	22	18	18,5	5	1	199,00
81507241535	1535	75	22	18	18,5	5	1	245,00
81507241700	1700	75	22	18	18,5	5	1	265,00
81507241845	1845	75	22	18	18,5	5	1	275,00
81507242000	2000	75	22	18	18,5	5	1	295,00

Der Mastkern besteht aus GFK - das Laminat aus Carbon, mit Klarlack versiegelt. Jeder Mast wird in einer Stofftasche geliefert.

The core of the pole is made of GRP - the laminate is made of carbon sealed with clear varnish. Every pole will be delivered in a soft bag.

Le noyau du poteau est en GRP - le stratifié est en carbone scellé avec un vernis transparent. Chaque mât sera livré dans un sac souple.



Technische Informationen

Technical information

Informations techniques



Yachtzubehör, Ausrüstung und Spezielles

Yachting accessories, equipment and highlights

Equipement et accessoires exclusifs pour yachts

8



Sockel für Sonnensegelmast / A4-AISI 316

Socket for sunshade pole / Embase pour mât

815073

NEW

Artikel-Nr. Item-no.	Für Rohr-Ø For tube-Ø	D	D1	K	H1	GW	Antrieb Drive	Box	*€/Stück *€/piece
815073440	22	40	36	13-22	85	1/2"	SW19	1	67,00
815073458	22	58	36	9-14	85	1/2"	SW19	1	81,00
8150734P	Platte für / Anti-twist plate for / Anti-torsion pour 815073440							1	17,00

Die Installationsplatte hat eine Nut für die Fase am Sockel 815073440 und verhindert ein Verdrehen des Mastes. Wir empfehlen Linsensenk-Blechsrauben DIN 7983 4,8mm oder Linsensenkschrauben DIN 966 M5.

The installation plate has a notch and fits to the bevel of the socket 815073440 to prevent a mast twisting.

We recommend countersunk tapping screws DIN 7983 4.8mm or countersunk screws DIN 966 M5.

La plaque d'installation a une rainure pour la base 815073440 pour éviter une torsion du mât.

Nous recommandons des vis à tôle à tête fraisée DIN 7983 4,8mm ou vis à tête fraisée DIN 966 M5.



Technische Informationen
Technical information
Informations techniques



815073440

815073458

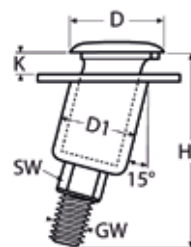

8150734P



Sockel mit Deckel für Sonnensegelmast / A4-AISI 316

Socket with cap for sunshade pole / Embase avec capuchon pour mât

815074

NEW

Artikel-Nr. Item-no.	Für Rohr-Ø For tube-Ø	D	D1	H1	H2	BD	Box	*€/Stück *€/piece
815074467	22	67	28	49	13	***5,8	1	79,00

***Wir empfehlen Linsensenk-Blechsrauben DIN 7983 4,8mm oder Linsensenkschrauben DIN 966 M5

***We recommend countersunk tapping screws DIN 7983 4.8mm or countersunk screws DIN 966 M5.

***Nous recommandons des vis à tôle à tête fraisée DIN 7983 4,8mm ou vis à tête fraisée DIN 966 M5.



Technische Informationen
Technical information
Informations techniques

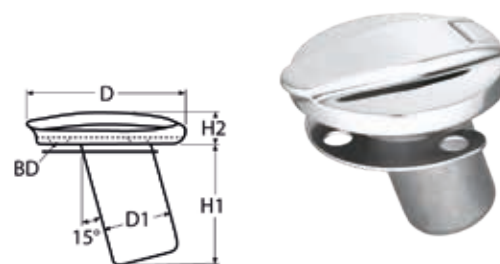

815075

Schnellspannhaken für Sonnensegelmast / A4-AISI 316
 Quick release hook for sunshade pole / Crochet à dégageement rapide pour mât

NEW

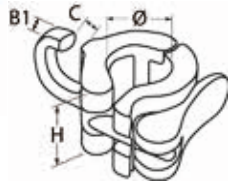

Artikel-Nr. Item-no.	Für Rohr-Ø For tube-Ø	C	B1	H	Box	*€/Stück *€/piece
8150754185	18,5	5	8	24	1	86,00

Für eine stufenlose Höhenverstellung einer Segelecke am Sonnensegelmast. Oder zum Aufhängen von z.B. Handtüchern.

For a stepless height adjustment of a sail corner at the sunshade pole. Or to hang up a towel.

Pour un réglage en hauteur en continu d'un angle de voile sur le mât. Ou pour suspendre des serviettes.



Technische Informationen

Technical information

Informations techniques

815077

Relinghalter für Sonnensegelmast / A4-AISI 316
 Rail mount for sunshade pole / Support sur rail pour mât



NEW



815077432A

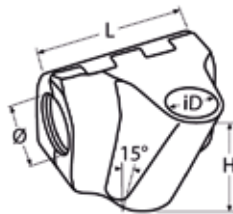

815077432B



Artikel-Nr. Item-no.	Ausführung Type	Für Rohr-Ø For tube-Ø	iD	L	H	Box	*€/Stück *€/piece
815077432A	A	32	22	80	61	1	159,00
815077432B	B	32	22	80	61	1	159,00

Durchmesser der Relingstütze max. 25mm / Diameter of the stanchion max. 25mm / Diamètre du poteau max. 25mm

Technische Informationen

Technical information

Informations techniques



8509

Horn / A2-AISI 304
 Horn / Corne de brume

Artikel-Nr. Item-no.	L	dB	Ampere	Volt	Box	*€/Stück *€/piece
85092410	410	115	3	12	1	138,00

Yachtzubehör, Ausrüstung und Spezielles

Yachting accessories, equipment and highlights
Equipement et accessoires exclusifs pour yachts

8

Fanfare / A2-AISI 304
Fanfare / Double corne de brume

8510

Artikel-Nr. Item-no.	L	dB	Ampere	Volt	Box	*€/Stück *€/piece
85102465	465	115	6	12	1	205,30

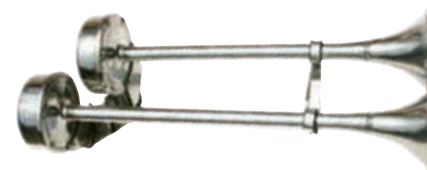
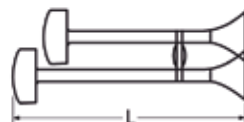

Kabeldecksdurchführung / Messing verchromt

Cable outlet - Brass, chrome plated / Passe câble pour pont du bateau - Laiton chromé

8726

Artikel-Nr. Item-no.	Für Kabel-Ø For cable-Ø	D	H	S	BD	Antrieb Drive	Box	*€/Stück *€/piece
8726706	6	32	15	3	4	-	5	8,40
8726708	8	32	15	3	4	-	5	8,90
8726710	10	38	20	3	4	SW24	5	12,70
8726712	12	38	20	3	4	SW24	5	15,80

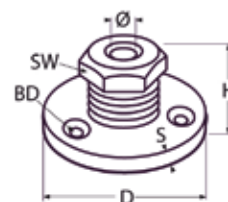

Kabeldecksdurchführung / A4-AISI 316
Deck cable passage / Passe câble pour pont du bateau

814059

Artikel-Nr. Item-no.	Für Kabel-Ø For cable-Ø	D	H	S	BD	Antrieb Drive	Box	*€/Stück *€/piece
814059404 11	4-11	51	27	7	4,5	SW22	1	42,00
814059412 20	12-20	62	32	8	4,5	SW32	1	56,00

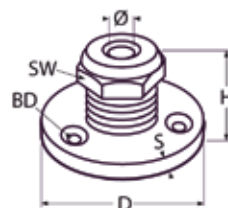

Ruderdolle Gabel / A4-AISI 316
Oarlock fork / Dame de nage à chape

814712

Artikel-Nr. Item-no.	C	Box	*€/Stück *€/piece
814712450	50	2	26,50



814723

Ruderdolle Ring / A4-AISI 316

Oarlock ring / Dame ne nage ronde

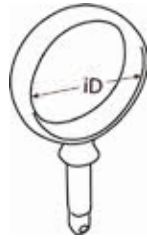

Artikel-Nr. Item-no.	iD	Box	*€/Stück *€/piece
814723449	49	2	26,90
814723457	57	2	31,00

814713

Ruderdollensockel gewinkelt / A4-AISI 316

Oarlock socket with angle bracket / Support pour dame de nage, allongé

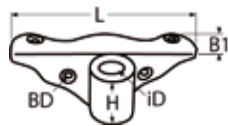

Artikel-Nr. Item-no.	L	B1	H	iD	BD	Box	*€/Stück *€/piece
8147134	100	18	36	13	4,8	2	17,00

Für Artikel 814712 + 814723

For article 814712 + 814723

Pour article : 814712 + 814723

814714

Ruderdollensockel flach / A4-AISI 316

Oarlock socket for side mount / Support pour dame de nage, plat

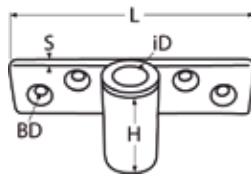

Artikel-Nr. Item-no.	L	H	iD	S	BD	Box	*€/Stück *€/piece
8147144	92	37	13	4,5	4,8	2	16,40

Für Artikel 814712 + 814723

For article 814712 + 814723

Pour article : 814712 + 814723

814715

Ruderdollensockel für Einbau / A4-AISI 316

Oarlock socket for installation / Support de dame de nage

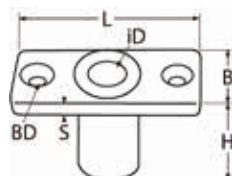

Artikel-Nr. Item-no.	L	B	H	iD	S	BD	Box	*€/Stück *€/piece
8147154	60	25	40	13	6,5	4,8	2	19,30

Für Artikel 814712 + 814723

For article 814712 + 814723

Pour article : 814712 + 814723

Werkzeug, Reparatur und Pflege

Tools, repair and maintenance

Outils de réparations et de maintenance

Kapitel 9

Chapter 9



Werkzeuge

Tools
Outils



Reparatur + Pflege

Repair + maintenance
Réparations + maintenance



814733

Bit-Sortiment 1/4" 122-tlg. / Chrom Vanadium
 Bit assortment 1/4" 122 pcs. / Boîte d'embouts, 1/4" 122 pcs.

Artikel-Nr. Item-no.	Box	*€/Stück *€/piece
81473310122	1	53,00

Inhalt:

1/4" Bit-Schraubendreher / ERGOTORQUE Bit screwdriver
1/4" Bithalter magnetisch / Bit holder, magnetic
1/4" Steckadapter: 25mm; 50mm / Square drive adaptor, for bit ratchet
1/4" Bit-Adapter-Stecknuss Chrom / CHROMEplus Bit adaptor socket
1/4" Bit Flügelmutter / Bit wing nut
1/4" Sechskantnuss / Hexagon nut bit:
4mm; 5mm; 6mm; 7mm; 8mm; 9mm; 10mm; 11mm; 12mm; 13mm
1/4" Sechskantnuss magnetisch / Hexagon nut bit:
5/32"; 3/16"; 7/32"; 1/4"; 9/32"; 5/16"; 11/32"; 3/8"; 7/16" 1/2"
1/4" Bit Schlitz / Bit slot: 3mm; 4mm; 4,5mm; 5mm; 5,5mm; 6mm; 6,5mm; 7mm; 8mm
1/4" Bit Phillips / Bit phillips: PH00; PH0; PH1; PH2; PH3
1/4" Bit Poz / Bit pozi: PZ00; PZ0; PZ1; PZ2; PZ3
1/4" Bit Innensechskant / Bit hexagon:
1,5mm; 2mm; 2,5mm; 3mm; 4mm; 5mm; 5,5mm; 6mm; 8mm
1/4" Bit Innensechskant mit Bohrung: 2mm; 2,5mm; 3mm; 4mm; 5mm; 6mm
1/4" Bit TX / Bit TX: T5; T6; T7; T8; T9; T10; T15; T20; T20; T25; T27; T30; T40; T45
1/4" Bit TX mit Bohrung / Bit TX secure: TB8; TB10; TB15; TB20; TB25; TB27; TB30; TB35; TB40
1/4" Bit XZN / Bit XZN: M5; M6; M8
1/4" Bit Torque / Bit torque: 6mm; 8mm; 10mm
1/4" Bit Spanner / Spanner bit: 4mm; 6mm; 8mm; 10mm
1/4" Bit Triwing / Bit Triwing: 4mm #1; 6mm #2; 8mm #3; 10mm #4
1/4" Bit Doppelkeil / Bit: #1; #2; #3
1/4" Bit Vierkant / Bit square: #0; #1; #2; #3
1/4" Bit Sechskant / Bit hexagon: 1/16"; 5/64"; 3/32"; 7/64"; 1/8"; 9/64"; 5/32"; 3/16"; 7/32"; 1/4"
1/4" Bit 5-Stern mit Bohrung / Bit tamperproof five star:
TS10; TS15; TS20; TS25; TS27; TS30; TS40; TS45; TS50

814734

Bit-Sortiment Edelstahl 1/4" 18-tlg. / A2
 Bit assortment stainless steel 1/4" 18 pcs. / Boîte d'embouts en acier inox 1/4" 18 pcs.

Artikel-Nr. Item-no.	Box	*€/Stück *€/piece
814734218	1	65,00

Ideal zum Verschrauben von Edelstahlschrauben zur Vermeidung von Fremdrost.

Ideal for fixing of stainless steel screws to prevent external rust.

Parfait pour serrage de vis inox pour éviter rouille erratique

Inhalt:

1/4" Edelstahl Bithalter magnetisch / 1/4" STAINLESS STEEL quick release bit holder
1/4" Edelstahl Bit Pozi: PZ1; PZ2; PZ3 / 1/4" STAINLESS STEEL bit PZ: PZ1; PZ2; PZ3
1/4" Edelstahl Bit Phillips: PH1; PH2; PH3 / 1/4" STAINLESS STEEL bit PH: PH1; PH2; PH3
1/4" Edelstahl BitTX: T10; T15; T20; T25; T30; T40 /
1/4" STAINLESS STEEL bit Torx: T10; T15; T20; T25; T30; T40
1/4" Edelstahl Bit Innensechskant: 4mm; 5mm; 6mm /
1/4" STAINLESS STEEL bit hexagon: 4mm; 5mm; 6mm
1/4" Edelstahl Bit Schlitz: 5,5mm; 6,5mm / 1/4" STAINLESS STEEL bit for slotted screw: 5,5mm; 6,5mm

Bithalter magnetisch 1/4" / A2
Magnetic stainless steel bit holder 1/4" / Porte-embout magnétique de acier inox 1/4"

814999

Artikel-Nr. Item-no.	Box	*€/Stück *€/piece
814999214	1	5,00



Edelstahl-Bit 1/4" / A2
Stainless steel bit 1/4" / Embout pour vis de acier inox 1/4"

815000

Artikel-Nr. Item-no.	Antrieb Drive	Box	*€/Stück *€/piece
8150002PH1	PH1	5	3,00
8150002PH2	PH2	5	3,00
8150002PH3	PH3	5	3,00
8150002PZ1	PZ1	5	3,00
8150002PZ2	PZ2	5	3,00
8150002PZ3	PZ3	5	3,00
8150002TX10	TX10	5	3,00
8150002TX10PIN	TX10 Pin	5	4,00
8150002TX15	TX15	5	3,00
8150002TX15PIN	TX15 Pin	5	4,00
8150002TX20	TX20	5	3,00
8150002TX20PIN	TX20 Pin	5	4,00
8150002TX25	TX25	5	3,00
8150002TX25PIN	TX25 Pin	5	4,00
8150002TX30	TX30	5	3,00
8150002TX30PIN	TX30 Pin	5	4,00
8150002TX40	TX40	5	3,00
8150002TX40PIN	TX40 Pin	5	4,00
8150002SW4	SW4	5	3,00
8150002SW5	SW5	5	3,00
8150002SW6	SW6	5	3,00
8150002SZ55	SZ5,5	5	3,00
8150002SZ65	SZ6,5	5	3,00



Ideal zum Verschrauben von Edelstahlschrauben zur Vermeidung von Fremdstoff.
Ideal for fixing of stainless steel screws to prevent external rust.
Parfait pour serrage de vis inox pour éviter rouille erratique

NEW

Bit, magnetisch, 1/4" / CRV
Bit magnetic / Embout magnétique

815213

Artikel-Nr. Item-no.	Antrieb Drive	Box	*€/Stück *€/piece
81521310TX45PIN	TX45 Pin	1	3,00
81521310TX50PIN	TX50 Pin	1	3,20



815122

Sprenger Winch Bit / A4L-AISI 316L
 Sprenger Winch Bit / Sprenger treuil embout

NEW



Artikel-Nr.

Item-no.

Box

*€/Stück

*€/piece

8151224

1

60,00

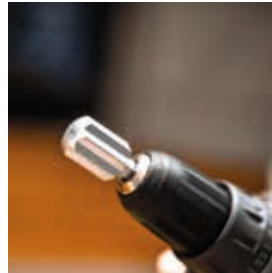

815149

Universal Deckelschlüssel / A4-AISI 316
 Universal lid key / Clé universelle pour le couvercle

NEW

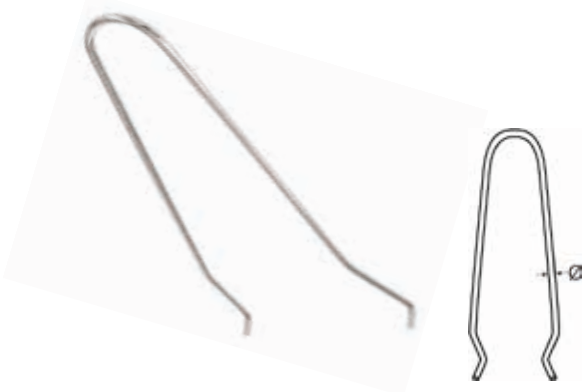

Artikel-Nr.

Item-no.

Ø

Box

*€/Stück

*€/piece

8151494

3,5

5

4,00

Passend auch für Inspektionsdeckel Art. 8556 auf Seite 368 und Einfüllstutzen Art. 8314 auf Seite 377 und viele andere Anwendungszwecke

Fits especially for inspection port item 8556 on page 368 and deck fill item 8314 on page 377 and many other applications

Convient aussi aux couvercles d'inspection art. 8556 à la page 368 et aux goulottes de remplissage art. 8314 à la page 377 et à de nombreuses autres applications

815087

Universal Decksschlüssel / A2-AISI 304
 Universal deck key / Clé de pont universelle

NEW

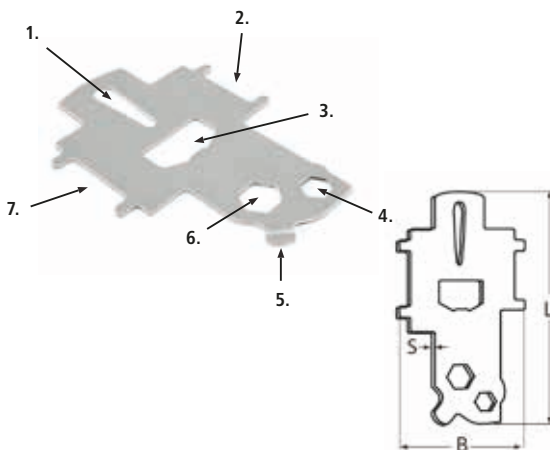

Artikel-Nr.

Item-no.

L

B

S

Box

*€/Stück

*€/piece

815087298

98

70

2

5

5,00

1. Schäkelloffner / Shackle opener / Ouvre-manille

2. Deckelloffner / Lid opener / Ouvre-couvercle

3. Flaschenöffner / Bottle opener / Ouvre-bouteille

4. Schlüsselweite 8mm / Wrench size 8mm / Lageur de clé 8mm

5. Schraubendreher / Screwdriver / Tournevis

6. Schlüsselweite 11mm / Wrench size 11mm / Lageur de clé 11mm

7. Einfüllstutzenöffner / Deck fill opener / Ouvre-colad de remplissage

ResQ-plast / Baumwolle/PP/Elasthan
ResQ-plast - Cotton/PP/Spandex / ResQ-plast - Coton/PP/Elasthanne

Artikel-Nr. Item-no.	Farbe Colour	Breit Width	Länge Length	Box	*€/Stück *€/piece
814974325BL	Blau / Blue	25	4500	1	9,80
814974325BE	Beige / Beige	25	4500	1	9,80
814974325SC	Schwarz / Black	25	4500	1	9,80
814974325TF	Tarnfarben / Camouflage	25	4500	1	9,80
814974325GR	Grün / Green	25	4500	1	9,80
814974325RO	Rot / Red	25	4500	1	9,80
814974325TU	Türkis / Turquoise	25	4500	1	9,80
814974325WE	Weiss / White	25	4500	1	9,80



ResQ-plast ist ein atmungsaktives Pflaster.

ResQ-plast ist ausgezeichnet geeignet für:

- Verletzungen an den Fingern, Zehen, etc.
- Schnitte, Abschürfungen, Wunden
- Blasen
- Als Druckverband
- Bei Gelenkverletzungen
- Für Tiere (verklebt nicht mit Fell)

Besondere Eigenschaften:

- Latexfrei - ideal bei Pflasterallergie
- Selbsthaftend ohne Klebstoff
- Dauerhaft atmungsaktiv
- Dauerelastisch
- Wasserbeständig
- Widersteht Öl, Fett und Schmutz
- Klebt nicht an Haut und Haar

ResQ-plast ist als einziges Produkt seiner Art von der FDA – Federal Drug Administration – (der Aufsichtsbehörde für Medizinprodukte in den USA) geprüft und für den medizinischen Gebrauch zugelassen.

ResQ-plast is a breathable plaster.

ResQ-plast is ideal for:

- injuries to fingers, toes, etc.
- cuts, scrapes, wounds
- blisters
- as a compression bandage
- for joint injuries
- animals (does not stick to fur)

Special features:

- ideal for plaster allergies, latex free
- self-adhesive without glue
- permanently breathable
- permanently elastic
- water resistant
- resists oil, grease and dirt
- does not stick to skin and hair

ResQ-plast is the only product of its kind approved by the FDA U.S. Federal Drug Administration – and approved for medical use.

ResQ-plast est un plâtre respirant

Notre ResQ-plast est un plâtre respirant pour:

- blessures aux doigts, aux orteils, etc.
- coupures, écorchures, plaies
- bulles
- En bandage de pression
- En cas de blessures articulaires
- Pour les animaux (non collé à la fourrure)

Particularités:

- Sans latex - idéal pour les allergies au plâtre
- Auto-adhésif sans adhésif
- Respirant en permanence
- Élastique en permanence
- Résistant à l'eau
- Résiste à l'huile, à la graisse et à la saleté
- Ne colle pas à la peau et aux cheveux (en conséquence aussi pour les animaux)

ResQ-plast est le seul produit du genre de la FDA – Fédéral Drug Administration - (l'agence de réglementation des dispositifs médicaux USA) et approuvé pour un usage médical.



814880

ResQ-tape® Reparaturband / Silikon

ResQ-tape® repair tape - Silicon / Bande de réparation "ResQ-tape" - Silicon



Artikel-Nr. Item-no.	Farbe Colour	Breite Width	Länge Length	Box	*€/Stück *€/piece
8148803S	Schwarz / Black / Noir	25	3650	1	27,00
8148803R	Rot / Red / Rouge	25	3650	1	27,00
8148803T	Transparent	25	3650	1	27,00
8148803W	Weiss / White / Blanc	25	3650	1	27,00
8148803B	Blau / Blue / Bleu	25	3650	1	27,00

ResQ-tape® ist ein hochwertiges, selbstverschweißendes Silikon-Band für Notfälle und Reparaturen. Da ResQ-tape® nur an sich selbst haftet, kann es auch direkt auf nassen und schmutzigen Untergründen verarbeitet werden. Im Gegensatz zu herkömmlichen Klebebändern ist die Beschaffenheit des Untergrundes egal. Indem man das Band dehnt und überlappend um den zu reparierenden Gegenstand wickelt, entsteht innerhalb weniger Sekunden eine dauerhafte Verbindung.

ResQ-tape® kann eingesetzt werden um zwei Gegenstände zu verbinden oder um undichte Stellen zu reparieren. Es bildet blitzschnell eine dauerhafte luft- und wasserdichte Versiegelung. So können Sie z.B. Leckagen in Rohrleitungen oder Schläuchen reparieren und das Ganze funktioniert sogar unter Wasser! Auch kann das Band für elektrische Isolierungen eingesetzt werden, oder um die Griffe von Werkzeugen und Sportgeräte griffiger und rutschfest zu machen. Das ResQ-tape® lässt sich leicht und vollkommen rückstandsfrei auch von den empfindlichsten Untergründen entfernen, z.B. Chrom, Lacke, Stoffe, Kohlefaser, etc...

ResQ-tape®, made of pure silicone, is the most versatile self-fusing repair tape for emergencies and all-purpose repairs. ResQ-tape® is the strongest, fastest-fusing repair tape and can be used under very critical conditions. Just by stretching and wrapping it around an object onto itself, it will quickly and easily create a permanent airtight, waterproof seal in just seconds! It can even (without cleaning first) be used on dirty and wet surfaces. It will remain flexible and not become brittle after being exposed to sunlight. ResQ-tape® let you repair leaks on plumbing and hoses in a flash, make underwater repairs, use it on electrical wiring or as shrink-wrap, wrap tool handles, connect two separate objects and much...much more! ResQ-tape® is easy to remove and will never leave a residue!

ResQ-tape® est un ruban de silicone auto-soudant de haute qualité pour les urgences et les réparations. Car ResQ-tape® adhère uniquement à lui-même, il peut également directement sur les surfaces humides et sales traitées. Contrairement aux rubans adhésifs conventionnels, la nature de la surface est la matière. En étirant et en chevauchant le ruban autour de l'élément à réparer, une connexion permanente est créée en quelques secondes. ResQ-tape® peut être utilisé pour connecter deux objets ou pour colmater les fuites réparation. Il forme un joint étanche à l'air et à l'eau à une vitesse fulgurante. Ainsi, vous pouvez par exemple réparer les fuites dans les tuyaux ou les tuyaux et le tout fonctionne même sous l'eau! Le ruban peut également être utilisé pour l'isolation électrique ou autour des poignées d'outils et rendre les équipements sportifs plus adhérents et antidérapants. Le ResQ-tape® est facile et parfait. Éliminez sans résidus, même des substrats les plus sensibles, par ex. Chrome, peintures, tissu, fibre de carbone, etc.

814884

ResQ-tape/plast Display mit 9 Haken / Karton

ResQ-tape/plast display with 9 hooks - Carton / Présentoir de vente pour ResQ-tape/plast avec 9 crochets - Carton

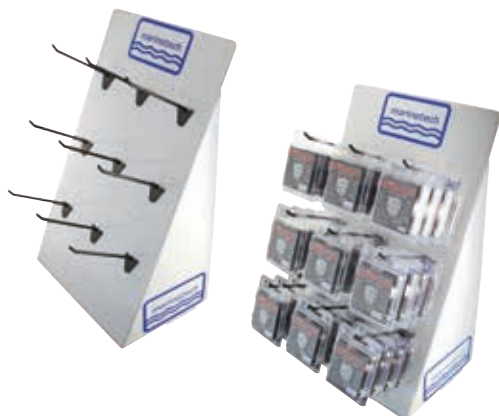

Artikel-Nr. Item-no.	H	B	Box	*€/Stück *€/piece
8148843310	500	310	1	24,00

Die optimale Lösung das ResQ-tape zu präsentieren.

Auf einen Haken passen bis zu 3 ResQ-tapes.

Typen nicht im Lieferumfang enthalten

The best solution to present the ResQ-tape.

Up to 3 ResQ-tapes per hook. Tapes not included.

La solution optimale pour présenter la bande ResQ.

Un crochet peut contenir jusqu'à 3 bandes ResQ.

Les bandes non inclus dans la livraison.

Akku Polier- und Schleifmaschine

Battery polisher and grinder / Polisseuse et ponceuse sur batterie

814831

Artikel-Nr. Item-no.	L	Box	*€/Stück *€/piece
8148313260	260	1	150,00
8148313Akku	Ersatzakku für Polier- und Schleifmaschine Replacement battery for polisher and grinder	1	34,00
814831ADAPTER-UK	Adapter Stecker UK 3-polig Adapter plug UK 3-poles	1	5,00



Technische Spezifikationen:

Akku: 12V x 1500 mAh lithium-Ionen
Leerlaufdrehzahl: 0-3000 U/min
Klettscheibendurchmesser: 80mm
Gewicht: 0,8kg

Lieferumfang:

2 x Akku Lithium-Ionen
1 x Ladegerät
1 x Koffer
1 x Polierpad aus Frottee
1 x Polierpad aus Lammfell
1 x Schwammpad
1 x Schleifteller
1 x Schleifscheibe Körnung 120

Technical specifications :

Lithium-Ion-battery: 12V, 1500mAh
No load speed : 0-3000 rpm
Disc size: 80mm
Weight: 0,8kg

Included:

2 x Lithium-Ion-battery
1 x Charger
1 x Case
1 x Towel pad
1 x Woolen pad
1 x Sponge pad
1 x Polishing pad
1 x Sand paper grain 120

Spécifications techniques:

Batterie lithium-ion: 12V, 1500mA
Vitesse du ralenti: 0-3000 tours par minute
Diamètre du disque velcro: 80mm
Poids: 0,8kg

Contenu de la livraison :

2 x batterie lithium-ion
1 x chargeur
1 x coffre
1 x Disque de polissage tissu éponge
1 x Disque de polissage fourrure d'agneau
1 x Disque de polissage éponge
1 x Disque de meulage
1 x Disque de polissage grain de sable 120

Aufgrund des fehlenden automatischen Drehzahlausgleichs empfehlen wir das Gerät nicht! auf Lackoberflächen zu verwenden.

As there is no automatic speed compensation, we recommend that the device is not used on painted surfaces.

En raison de l'absence de compensation automatique de la vitesse, nous recommandons de ne pas utiliser la machine sur des surfaces peintes.

Klettscheiben für Polier- und Schleifmaschine

Discs for polisher and grinder / Disque de polissage

814832

Artikel-Nr. Item-no.	Ausführung Type	Box	*€/Stück *€/piece
814832-01	Frottee / Towel	5	1,50
814832-02	Lammfell / Wool	5	2,00
814832-03	Schwamm / Sponge	5	2,00
814832-04	Schleifteller / Polishing pad	5	2,50
814832-05	Sand - 120	5	0,50
814832-06	Sand - 180	5	0,50
814832-07	Sand - 80	5	0,50



814850

Hochglanz-Metallpolitur Wachs Unipol blau

Metal polish wax Unipol blue / Cire à polir brillant les métaux, Unipol bleu



Artikel-Nr. Item-no.	Inhalt Content	Box	*€/Stück *€/piece
814850110	110g	1	5,10
814850700	700g	1	14,50

Geeignet für Poliermaschinen ab 4000 U/min.

Usable for polishing machines from 4000rpm.

Apte pour polisseuse de 4.000 tours par minute.

814851

Hochglanz-Metallpolitur Paste Unipol blau

Metal polish paste Unipol blue / Pâte à polir brillant les métaux, Unipol bleu



Artikel-Nr. Item-no.	Inhalt Content	Box	*€/Stück *€/piece
814851125	125g	1	23,00

814853

Acrylpolitur Paste Unipol

Acryl polish paste Unipol / Pâte à polir l'acrylique, Unipol



Artikel-Nr. Item-no.	Inhalt Content	Box	*€/Stück *€/piece
814853125	125g	1	23,00

814855

Tikal Tef-Gel

Tikal Tef-Gel / Tikal Tef-Gel



Artikel-Nr. Item-no.	Inhalt Content	Box	*€/Stück *€/piece
81485510	10g	5	12,00
81485560	60g	1	46,00

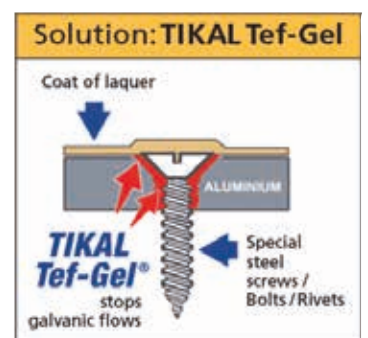
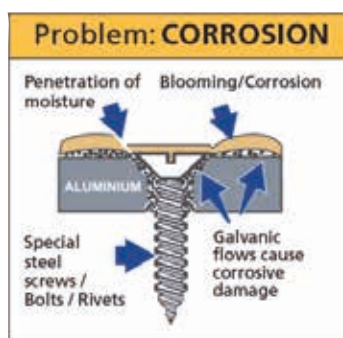
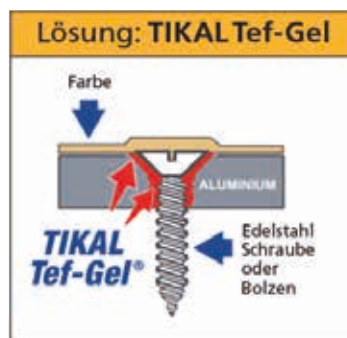
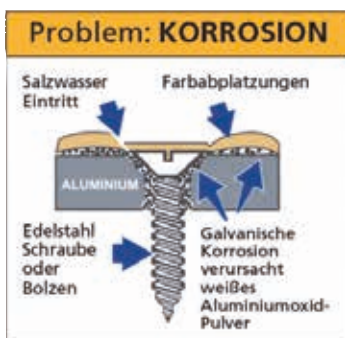

Klappmesser mit Alu-Griff / A2-AISI 304 / Alu
Jackknife with alu handle / Couteau pliant avec manche

8637

Artikel-Nr. Item-no.	L	Box	*€/Stück *€/piece
86372110	170	5	13,00



Klinge Edelstahl, Griff Alu
Blade stainless steel, handle alu
Lame en acier. Poignée en aluminium

Klappmesser mit Alu-Griff / A2-AISI 304 / Alu
Jackknife with alu handle / Couteau pliant avec manche

814153

Artikel-Nr. Item-no.	L	B	Box	*€/Stück *€/piece
8141530	185	30	5	11,50



Klinge Edelstahl, Griff Alu
Blade stainless steel, handle alu
Lame en acier. Poignée en aluminium

Klappmesser mit Alu-Griff / A2-AISI 304 / Alu
Jackknife with alu handle / Couteau pliant avec manche

814948

Artikel-Nr. Item-no.	L	B	Box	*€/Stück *€/piece
8149482175	175	25	5	10,50



Klinge Edelstahl, Griff Alu
Blade stainless steel, handle alu
Lame en acier. Poignée en aluminium

Fischmesser mit Köcher / A2-AISI 304 / Plastik
Fish knife with quiver / Couteau à poisson avec carquois

814226

Artikel-Nr. Item-no.	L	Box	*€/Stück *€/piece
8142262210	210	5	11,60



Klinge Edelstahl, Griff aus Kunststoff.
Blade made of stainless steel. Handle made of plastic.
Lame en acier. Poignée en plastique.



9

Werkzeug, Reparatur und Pflege

Tools, repair and maintenance

Outils de réparations et de maintenance

814803

Klappmesser mit Alu-Griff / A2-AISI 304 / Alu

Jackknife with alu handle / Couteau pliant avec manche



Artikel-Nr. Item-no.	L	B	Box	*€/Stück *€/piece
8148032130	130	30	5	13,00

Klinge Edelstahl.

Blade made of stainless steel.

Lame en acier.

814804

Klappmesser mit Holzgriff / A2-AISI 304 / Holz

Jackknife with wood handle / Couteau pliant avec manche en bois



Artikel-Nr. Item-no.	L	B	Box	*€/Stück *€/piece
8148042155	155	15	5	13,00

Klinge Edelstahl.

Blade made of stainless steel.

Lame en acier.

8277

Takelmesser / A2-AISI 304

Sailors knife / Couteau marin



Artikel-Nr. Item-no.	L	Box	*€/Stück *€/piece
82772105	95	5	15,50

8415

Multitool „Marineman Classic“ / A2-AISI 304

Multitool "Marineman Classic" / Outil multi "Marineman Classic"



Artikel-Nr. Item-no.	Ausführung Type	Box	*€/Stück *€/piece
84152TASCHE	Mit Tasche / With case	10	16,00

814816

Multitool "Marineman Multi Repair" / A2-AISI 304

Multitool "Marineman Multi Repair" / Outil multi "Marineman Multi Repair"



Artikel-Nr. Item-no.	L	Ausführung Type	Box	*€/Stück *€/piece
8148162095	95	Mit Tasche + Bits / With case + bits	5	19,00

Aufnahme Rollgabelschlüssel max. Schlüsselweite 13mm.

Adjustable wrench for max. across flat 13mm.

Support pour clés à fourche à galet taille de clé max. 13mm.

Fittinge und Schellen

Fittings and hose clamps

Raccords et colliers

Kapitel 10

Chapter 10



Fittinge

Fittings
Passe-coques



Schellen

Hose clamps
Colliers



10

Fitte und Schellen

Fittings and hose clamps
Raccords et colliers

8748

Borrdurchlass mit Schlauchanschluss / A4-AISI 316 / Nylon
Thru-hull with hose connection / Passe-coque avec raccord de tuyau

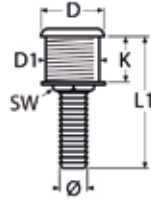

Artikel-Nr. Item-no.	Für Schlauch-Ø For hose-Ø	L1	K	D	D1	SW	Box	*€/Stück *€/piece
8748458	16 (5/8")	75	31	48	33,5	46	1	15,30
8748434	19 (3/4")	81	31	48	33,5	46	1	16,40
874841	25 (1")	79	31	48	33,5	46	1	16,80
874841 14	32 (1 1/4")	96	35	60	41,0	55	1	24,70
874841 12	38 (1 1/2")	96	35	60	41,0	55	1	22,30

Geprüft nach ASTM D638 und ASTM D790. Die Borrdurchlässe bestehen aus Nylon mit 30% Glasfaserteil.
Tested according to ASTM D638 and ASTM D790. The thru-hulls are made of nylon with 30% of glass fibre.
Testé selon ASTM D638 et ASTM D790. Les passe-coque sont en nylon avec fibre de verre 30%.

814757

Borrdurchlass mit Schlauchanschluss / Nylon
Thru-hull with hose connection / Passe-coque avec raccord de tuyau

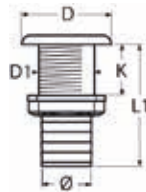

Artikel-Nr. Item-no.	Für Schlauch-Ø For hose-Ø	L1	K	D	D1	Box	*€/Stück *€/piece
814757358	16 (5/8")	71	23	42	20,5	5	2,50
814757334	19 (3/4")	76	25	51	26,0	5	3,30
81475731	25 (1")	87	29	62	32,5	5	3,40
81475731 14	32 (1 1/4")	91	31	69	40,5	5	4,50
81475731 12	38 (1 1/2")	96	27	74	47,0	5	5,80

8605

Borrdurchlass mit Gewinde / A4-AISI 316
Thru-hull with thread / Passe-coque avec filetage

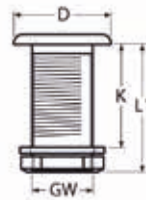

Artikel-Nr. Item-no.	GW	L1	K	D	Box	*€/Stück *€/piece
8605438	3/8"	54	45	35	1	24,30
8605412	1/2"	59	50	40	1	24,80
8605434	3/4"	65	54	47	1	25,00
860541	1"	73	62	55	1	34,10
860541 14	1 1/4"	77	67	64	1	45,50
860541 12	1 1/2"	83	67	75	1	55,90

8620

Borrdurchlass mit Schlauchanschluss / A4-AISI 316
Thru-hull with hose connection / Passe-coque avec raccord de tuyau

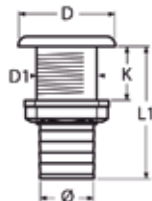

Artikel-Nr. Item-no.	Für Schlauch-Ø For hose-Ø	L1	K	D	D1	Box	*€/Stück *€/piece
8620438	10 (3/8")	52	21	35	16,5	1	16,50
8620412	13 (1/2")	52	22	35	16,5	1	17,00
8620434	19 (3/4")	59	19	39	26,5	1	19,00
862041	25 (1")	68	30	49	33,0	1	26,00
862041 14	32 (1 1/4")	72	30	55	42,0	1	37,50
862041 12	38 (1 1/2")	77	33	64	47,5	1	46,00

Fittinge und Schellen

Fittings and hose clamps

Raccords et colliers

10

Borrdurchlass mit Schlauchanschluss, lang / A4-AISI 316

Thru-hull with hose connection, long / Passe-coque avec raccord de tuyau, longue

814936

Artikel-Nr. Item-no.	Für Schlauch-Ø For hose-Ø	L1	K	D	D1	Box	*€/Stück *€/piece
814936434	19 (3/4")	97	46	46,5	26,5	1	23,70
81493641	25 (1")	97	44	54,0	33,0	1	33,80
81493641 12	38 (1 1/2")	97	49	69,5	47,5	1	39,00

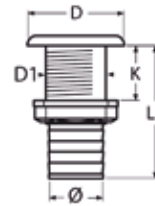

Wasserablauf mit Gewinde / A4-AISI 316

Water drain with thread / Evacuation d'eau avec filetage

8639

Artikel-Nr. Item-no.	GW	L1	K	B	Box	*€/Stück *€/piece
8639438	3/8"	67	57	78	1	29,90
8639412	1/2"	72	60	90	1	32,80
8639434	3/4"	80	67	103	1	44,00
863941	1"	75	65	107	1	44,50
863941 14	1 1/4"	77	65	116	1	46,70
863941 12	1 1/2"	81	71	133	1	62,40



Borrdurchlass mit Schlauchanschluss, 90° / A4-AISI 316 / Nylon

Thru-hull with hose connection, 90° / Passe-coque avec raccord de tuyau, 90°

8749

Artikel-Nr. Item-no.	Für Schlauch-Ø For hose-Ø	L1	K	D	D1	SW	Box	*€/Stück *€/piece
8749434	19 (3/4")	82	30	48	33	46	1	18,70
874941	25 (1")	108	35	60	41	46	1	22,00
874941 12	38 (1 1/2")	112	34	60	41	55	1	24,60

Geprüft nach ASTM D638 und ASTM D790. Die Borrdurchlässe bestehen aus Nylon mit 30% Glasfaseranteil.
 Tested according to ASTM D638 and ASTM D790. The thru-hulls are made of nylon with 30% of glass fibre.
 Testé selon ASTM D638 et ASTM D790. Les passe-coque sont en nylon avec fibre der verre 30%.

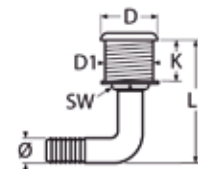

Borrdurchlass mit Schlauchanschluss, 90° / A4-AISI 316

Thru-hull with hose connection, 90° / Passe-coque avec raccord de tuyau, 90°

8893

Artikel-Nr. Item-no.	Für Schlauch-Ø For hose-Ø	L1	D	K	D1	Box	*€/Stück *€/piece
8893434	19 (3/4")	62	45	19	32	1	47,70
889341	25 (1")	65	45	19	32	1	53,00
889341 12	38 (1 1/2")	82	61	21	41	1	96,40

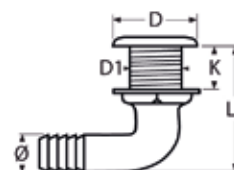

10

10

Fitte und Schellen

Fittings and hose clamps
Raccords et colliers

8621

Kugelhahnventil 2-tlg. / A4-AISI 316
Ball valve, 2-part / Vanne à boisseau sphérique, 2 parties



Artikel-Nr. Item-no.	GW	Betriebsdruck Bar Pressure nominal Bar	Box	*€/Stück *€/piece
8621438	3/8"	PN63	1	28,00
8621412	1/2"	PN63	1	28,50
8621434	3/4"	PN63	1	34,40
862141	1"	PN63	1	51,50
862141 14	1 1/4"	PN63	1	79,50
862141 12	1 1/2"	PN63	1	104,40
862142	2"	PN63	1	170,00

815021

Mini-Kugelhahnventil, Innengewinde / A4-AISI 316 / Plastik
Mini ball valve, inside thread / Mini vanne femelle



Artikel-Nr. Item-no.	GW	Betriebsdruck Bar Pressure nominal Bar	Box	*€/Stück *€/piece
815021414	1/4"	PN40	1	19,00
815021438	3/8"	PN40	1	20,00
815021412	1/2"	PN40	1	21,00

815022

Mini-Kugelhahnventil, Innen- und Außengewinde / A4-AISI 316 / Plastik
Mini ball valve internal and external thread / Mini vanne femelle et male



Artikel-Nr. Item-no.	GW	Betriebsdruck Bar Pressure nominal Bar	Box	*€/Stück *€/piece
815022414	1/4"	PN40	1	19,00
815022438	3/8"	PN40	1	20,00
815022412	1/2"	PN40	1	21,00

8638

T-Stück mit Innengewinde / A4-AISI 316
T-fitting with internal thread / Raccord en T avec filetage intérieur



Artikel-Nr. Item-no.	GW	Betriebsdruck Bar Pressure nominal Bar	Box	*€/Stück *€/piece
8638438	3/8"	PN10	1	6,80
8638412	1/2"	PN10	1	8,50
8638434	3/4"	PN10	1	13,90
863841	1"	PN10	1	18,00
863841 14	1 1/4"	PN10	1	24,10
863841 12	1 1/2"	PN10	1	30,50

Anschlussstück mit Innengewinde / A4-AISI 316
Socket with internal thread / Raccord avec filetage intérieur

8606

Artikel-Nr. Item-no.	GW	Betriebsdruck Bar Pressure nominal Bar	Box	*€/Stück *€/piece
8606414	1/4"	PN10	1	4,10
8606438	3/8"	PN10	1	4,50
8606412	1/2"	PN10	1	6,60
8606434	3/4"	PN10	1	7,80
860641	1"	PN10	1	8,00
860641 14	1 1/4"	PN10	1	15,50
860641 12	1 1/2"	PN10	1	18,70



Rohrbogen, 45° mit Innengewinde / A4-AISI 316
Elbow fitting, 45° with internal thread / Coude femelle 45° - femelle en laiton

8623

Artikel-Nr. Item-no.	GW	Betriebsdruck Bar Pressure nominal Bar	Box	*€/Stück *€/piece
8623438	3/8"	PN10	1	5,30
8623412	1/2"	PN10	1	5,50
8623434	3/4"	PN10	1	5,60
862341	1"	PN10	1	11,60
862341 14	1 1/4"	PN10	1	20,80
862341 12	1 1/2"	PN10	1	22,30



Rohrbogen mit Innen-/Außengewinde, 90° / A4-AISI 316
Elbow fitting with internal-/external thread, 90° / Coude avec filetage intérieur et extérieur, 90°

8625

Artikel-Nr. Item-no.	GW	Betriebsdruck Bar Pressure nominal Bar	Box	*€/Stück *€/piece
8625438	3/8"	PN10	1	5,80
8625412	1/2"	PN10	1	6,20
8625434	3/4"	PN10	1	8,60
862541	1"	PN10	1	10,80
862541 14	1 1/4"	PN10	1	23,20
862541 12	1 1/2"	PN10	1	23,50



Rohrbogen mit Innengewinde, 90° / A4-AISI 316
Elbow fitting with internal thread, 90° / Coude avec filetage intérieur, 90°

8624

Artikel-Nr. Item-no.	GW	Betriebsdruck Bar Pressure nominal Bar	Box	*€/Stück *€/piece
8624438	3/8"	PN10	1	5,30
8624412	1/2"	PN10	1	5,70
8624434	3/4"	PN10	1	6,00
862441	1"	PN10	1	12,40
862441 14	1 1/4"	PN10	1	12,80
862441 12	1 1/2"	PN10	1	14,20



Fitte und Schellen

Fittings and hose clamps
Raccords et colliers

8622

Schlauchanschluss mit Außengewinde / A4-AISI 316

Hose connection with external thread / Raccord de tuyau avec filetage extérieur



Artikel-Nr. Item-no.	GW	Für Schlauch-Ø For hose-Ø	Box	*€/Stück *€/piece
8622438	3/8"	10	1	4,30
8622412	1/2"	13	1	7,10
8622434	3/4"	19	1	9,70
862241	1"	25	1	11,60
862241 14	1 1/4"	32	1	18,40
862241 12	1 1/2"	38	1	27,00

8640

Schlauchanschluss mit Innengewinde / A4-AISI 316

Hose connection with internal thread / Raccord de tuyau avec filetage intérieur



Artikel-Nr. Item-no.	GW	Für Schlauch-Ø For hose-Ø	Box	*€/Stück *€/piece
8640438	3/8"	10	1	7,90
8640412	1/2"	13	1	8,20
8640434	3/4"	19	1	13,30
864041	1"	25	1	14,00
864041 14	1 1/4"	32	1	18,60
864041 12	1 1/2"	38	1	23,70

8627

Doppelgewindestück mit Außengewinde / A4-AISI 316

Double nipple with external thread / Mamelon avec filetage extérieur



Artikel-Nr. Item-no.	GW	Betriebsdruck Bar Pressure nominal Bar	Box	*€/Stück *€/piece
8627414	1/4"	PN10	1	3,00
8627438	3/8"	PN10	1	4,30
8627412	1/2"	PN10	1	4,50
8627434	3/4"	PN10	1	6,60
862741	1"	PN10	1	6,80
862741 14	1 1/4"	PN10	1	15,40
862741 12	1 1/2"	PN10	1	18,40

8626

Reduzierstück mit Innen-/Außengewinde / A4-AISI 316

Reducing nipple with internal-/external thread / Réduction avec filetage intérieur et extérieur



Artikel-Nr. Item-no.	Außengewinde External thread	Innengewinde Internal thread	Betriebsdruck Bar Pressure nominal Bar	Box	*€/Stück *€/piece
8626412	1/2"	3/8"	PN10	1	4,30
8626434	3/4"	1/2"	PN10	1	6,20
862641	1"	3/4"	PN10	1	7,20
862641 14	1 1/4"	1"	PN10	1	9,50
862641 12	1 1/2"	1 1/4"	PN10	1	9,80

Fittinge und Schellen

Fittings and hose clamps
Raccords et colliers

10



Wasserhahn / A4-AISI 316
Water faucet / Robinet

8659

Artikel-Nr. Item-no.	Wandanschluß Wall conection	Schlauchanschluß Hose conection	Box	*€/Stück *€/piece
8659434 1	1/2"	3/4"	1	106,00

Durchflußmenge: ca.23 L/min. Geeigneter Wasserdruck bis 60psi (ca.4 Bar)

Flow rate: ca.23 L/min. Pressure to use under 60psi (ca.4 Bar)

Capacité débit env. 23L/min. Pression jusqu'à 60psi (ca. 4 Bar)



Kugelauslaufhahn / A4-AISI 316

Ball valve with hose connection / Robinet avec raccord pour tuyau souple

815023

Artikel-Nr. Item-no.	GW	Für Schlauch-Ø For hose-Ø	Box	*€/Stück *€/piece
815023412	1/2"	13	1	33,10
815023434	3/4"	16	1	37,50
81502341	1"	25	1	54,70



Schnellkupplung für Schlauch / A4-AISI 316

Quick connector for hose / Raccord rapide pour tuyau

815024

Artikel-Nr. Item-no.	Für Schlauch-Ø For hose-Ø	Betriebsdruck Bar Pressure nominal Bar	Box	*€/Stück *€/piece
815024413	13	PN12	1	33,50
815024419	19	PN12	1	34,40
815024425	25	PN12	1	35,80
815024432	32	PN12	1	36,80



Schnellkupplung mit Innengewinde / A4-AISI 316

Quick connector with internal thread / Raccord rapide filetage femelle

815025

Artikel-Nr. Item-no.	GW	Betriebsdruck Bar Pressure nominal Bar	Box	*€/Stück *€/piece
815025412	1/2"	PN12	1	30,00
815025434	3/4"	PN12	1	31,00
81502541	1"	PN12	1	32,00
81502541 14	1 1/4"	PN12	1	33,00
81502541 12	1 1/2"	PN12	1	34,00



10

815026

Schnellkupplung mit Außengewinde / A4-AISI 316

Quick connector with external thread / Raccord rapide filetage male



Artikel-Nr. Item-no.	GW	Betriebsdruck Bar Pressure nominal Bar	Box	*€/Stück *€/piece
815026412	1/2"	PN12	1	27,70
815026434	3/4"	PN12	1	28,90
81502641	1"	PN12	1	30,30
81502641 14	1 1/4"	PN12	1	32,00
81502641 12	1 1/2"	PN12	1	33,00

815027

Blindkappe mit Schnellkupplung / A4-AISI 316

Blind cap with quick connector / Capuchon aveugle avec raccord rapide



Artikel-Nr. Item-no.	Betriebsdruck Bar Pressure nominal Bar	Box	*€/Stück *€/piece
815027412	PN12	1	22,00

814563

Reduzierstück mit Innen-/Außengewinde / Messing

Reducing nipple with internal-/external thread - Brass / Réduction avec filetage intérieur et extérieur - Laiton



Artikel-Nr. Item-no.	Außengewinde External thread	Innengewinde Internal thread	Box	*€/Stück *€/piece
814563514 38	3/8"	1/4"	1	3,00
814563538 12	1/2"	3/8"	1	5,00
814563512 34	3/4"	1/2"	1	6,30
814563534 1	1"	3/4"	1	9,00

Doppelgewindestück mit Außengewinde / Messing
Double nipple with external thread - Brass / Mamelon avec filetage extérieur - Laiton

814564

Artikel-Nr. Item-no.	GW	Box	*€/Stück *€/piece
814564514	1/4"	1	2,00
814564538	3/8"	1	4,50
814564512	1/2"	1	5,10
814564534	3/4"	1	9,10
81456451	1"	1	9,50
81456451 14	1 1/4"	1	15,90
81456451 12	1 1/2"	1	22,20



Reduzierstück mit Außengewinde / Messing
Reducer nipple with external thread - Brass / Réduction avec filetage extérieur - Laiton

814565

Artikel-Nr. Item-no.	Außengewinde 1 External thread 1	Außengewinde 2 External thread 2	Box	*€/Stück *€/piece
814565538	3/8"	1/2"	1	4,40
814565512	1/2"	3/4"	1	7,10
814565534	3/4"	1"	1	9,50
81456551	1"	1 1/4"	1	13,20
81456551 14	1 1/4"	1 1/2"	1	20,80
81456551 12	2"	1/2"	1	42,70



Anschlussstück mit Innengewinde / Messing
Socket with internal thread - Brass / Raccord avec filetage intérieur - Laiton

814566

Artikel-Nr. Item-no.	GW	Box	*€/Stück *€/piece
814566538	3/8"	1	3,80
814566512	1/2"	1	7,60
814566534	3/4"	1	8,00
81456651	1"	1	10,00
81456651 14	1 1/4"	1	18,90
81456651 12	1 1/2"	1	25,30



Rohrbogen mit Innen-/Außengewinde, 90° / Messing
Elbow fitting with internal-/external thread, 90° - Brass / Coude avec filetage intérieur et extérieur, 90° - Laiton

814567

Artikel-Nr. Item-no.	GW	Box	*€/Stück *€/piece
814567514	1/4"	1	4,80
814567538	3/8"	1	7,30
814567512	1/2"	1	7,70
814567534	3/4"	1	13,30
81456751 14	1 1/4"	1	31,80
81456751 12	1 1/2"	1	38,80



10

Fitte und Schellen

Fittings and hose clamps
Raccords et colliers

814568

Rohrbogen mit Innengewinde, 90° / Messing

Elbow fitting with internal thread, 90° - Brass / Coude avec filetage intérieur, 90° - Laiton



Artikel-Nr. Item-no.	GW	Box	*€/Stück *€/piece
814568514	1/4"	1	4,30
814568538	3/8"	1	7,40
814568512	1/2"	1	9,30
814568534	3/4"	1	9,70
81456851	1"	1	30,00
81456851 14	1 1/4"	1	35,00
81456851 12	1 1/2"	1	55,00

814569

T-Stück mit Innengewinde / Messing

T-fitting with internal thread - Brass / Raccord en T avec filetage intérieur - Laiton



Artikel-Nr. Item-no.	GW	Box	*€/Stück *€/piece
814569514	1/4"	1	5,20
814569538	3/8"	1	5,50
814569512	1/2"	1	9,80
814569534	3/4"	1	11,50
81456951	1"	1	24,30
81456951 14	1 1/4"	1	28,50
81456951 12	1 1/2"	1	52,40

814572

Schlauchanschluss mit Innengewinde / Messing

Hose connector with internal thread - Brass / Raccord de tuyau avec filetage intérieur - Laiton



Artikel-Nr. Item-no.	GW	Für Schlauch-Ø For hose-Ø	Box	*€/Stück *€/piece
814572514 10	1/4"	10	1	5,50
814572514 13	1/4"	13	1	6,00
814572538 10	3/8"	10	1	6,30
814572538 13	3/8"	13	1	6,50
814572512 13	1/2"	13	1	6,90
814572512 19	1/2"	19	1	7,10
814572534 20	3/4"	19	1	7,60
81457251 25	1"	25	1	8,80
8145725114 32	1 1/4"	32	1	13,80
8145725112 38	1 1/2"	38	1	20,30
81457252 50	2"	50	1	31,60

814577

Wasserablauf mit Außengewinde / Messing

Water drain with external thread, brass / Crépine passe coque en laiton



Artikel-Nr. Item-no.	GW	Box	*€/Stück *€/piece
814577512	1/2"	1	49,10
814577534	3/4"	1	65,70
81457751	1"	1	74,80
81457751 14	1 1/4"	1	75,00
81457751 12	1 1/2"	1	85,00

Schlauchanschluss mit Außengewinde / Messing
Hose connector with external thread - Brass / Raccord de tuyau avec filetage extérieur - Laiton

814573

Artikel-Nr. Item-no.	GW	Für Schlauch-Ø For hose-Ø	Box	*€/Stück *€/piece
814573514 06	1/4"	6	1	4,00
814573514 08	1/4"	8	1	4,10
814573514 10	1/4"	10	1	4,20
814573514 13	1/4"	13	1	4,30
814573538 06	3/8"	6	1	5,40
814573538 08	3/8"	8	1	5,50
814573538 10	3/8"	10	1	5,60
814573538 13	3/8"	13	1	5,70
814573512 10	1/2"	10	1	5,10
814573512 13	1/2"	13	1	5,20
814573512 16	1/2"	16	1	5,30
814573512 20	1/2"	19	1	5,40
814573534 19	3/4"	19	1	7,30
814573534 25	3/4"	25	1	7,60
814573510 25	1"	25	1	7,80
8145735114 32	1 1/4"	32	1	10,20
8145735112 38	1 1/2"	38	1	18,40
81457352 50	2"	50	1	24,40



Stopfen mit Außengewinde / Messing
Plug with external thread - Brass / Bouchon avec filetage extérieur - Laiton

814574

Artikel-Nr. Item-no.	GW	Box	*€/Stück *€/piece
814574514	1/4"	1	2,30
814574538	3/8"	1	3,20
814574512	1/2"	1	3,80
814574534	3/4"	1	5,10
81457451	1"	1	6,70
8145745114	1 1/4"	1	10,50



Borrdurchlass mit Außengewinde / Messing
Thru-hull with external thread - Brass / Passe-coque avec filetage extérieur - Laiton

814576

Artikel-Nr. Item-no.	GW	Box	*€/Stück *€/piece
814576538	3/8"	1	23,50
814576512	1/2"	1	26,50
814576534	3/4"	1	36,70
81457651	1"	1	44,10
81457651 14	1 1/4"	1	60,00
81457651 12	1 1/2"	1	92,60
81457652	2"	1	97,70



10

Fitte und Schellen

Fittings and hose clamps
Raccords et colliers

8354

Rohrschelle / A4-AISI 316
Hose clamp / Collier de serrage



Artikel-Nr. Item-no.	Ausführung Type	Für Rohr-Ø For tube-Ø	L	B	A	S	BD	Box	*€/Stück *€/piece
NEW 8354422HALB	Halbschale Half circle	22	68	20	51	1,5	6,2	10	1,80
NEW 8354422VOLL	Vollschale Full circle	22	–	20	–	1,5	6,2	10	1,80
NEW 8354425HALB	Halbschale Half circle	25	68	20	51	1,5	6,2	10	1,80
NEW 8354425VOLL	Vollschale Full circle	25	–	20	–	1,5	6,2	10	1,80
NEW 83544GP	Grundplatte Ground plate	–	68	20	51	1,5	6,2	10	1,80

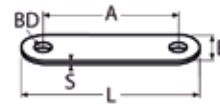
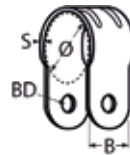
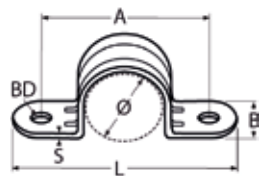

8357

Doppelschelle / A2-AISI 304
Hose clamp / Collier de serrage double



Artikel-Nr. Item-no.	Ausführung Type	Für Rohr-Ø For tube-Ø	Box	*€/Stück *€/piece
83572SINGLE	Einfach / Single	25	5	5,00
83572FEST	Doppelt, feststehend / Double fixed	25	5	10,00
83572WIRBEL	Doppelt mit Wirbel / Double with swivel	25	5	11,00

Halteschelle DIN 3016 mit Gummieinlage / A2-AISI 304
 Fastening clamps DIN 3016 with rubber inlay / Collier de fixation avec protection caoutchouc

3016

Artikel-Nr. Item-no.	Für Rohr-Ø For tube-Ø	BD	B	Box	*€/Stück *€/piece
301620812	8	5	12	100	0,90
301621012	10	5	12	100	0,90
301621212	12	5	12	100	1,10
301621512	15	5	12	100	1,10
301621812	18	5	12	100	1,10
301622015	20	6	15	50	1,30
301622215	22	6	15	50	1,60
301622515	25	6	15	50	1,60
301622815	28	6	15	50	1,60
301623015	30	6	15	50	1,60
301623220	32	8	20	25	3,10
301623520	35	8	20	25	3,10
301623820	38	8	20	25	3,10
301624020	40	8	20	25	3,10
301624820	48	8	20	10	3,10
301625020	50	8	20	10	3,10



1029

Gelenkbolzenschelle / A2-AISI 304 / A4-AISI 316

Heavy duty hose clamp/ Collier de serrage à tourbillon

Artikel-Nr. A2 Item-no. A2	Artikel-Nr. A4 Item-no. A4	Für Schlauch-Ø For hose-Ø	B	Max. Drehmoment Max. torque	Max. Druck Max. pressure	Antrieb Drive	Box	*€/Stück A2 *€/piece A2	*€/Stück A4 *€/piece A4
10292017 19	10294017 19	17-19	18	10 Nm	40 Bar	SW8	5/50	4,70	4,80
10292019 21	10294019 21	19-21	18	10 Nm	40 Bar	SW8	5/50	4,80	5,00
10292021 23	10294021 23	21-23	18	10 Nm	40 Bar	SW8	5/50	4,80	5,00
10292023 25	10294023 25	23-25	18	10 Nm	40 Bar	SW8	5/50	5,00	5,10
10292025 27	10294025 27	25-27	18	10 Nm	40 Bar	SW8	5/50	5,00	5,10
10292027 29	10294027 29	27-29	18	10 Nm	40 Bar	SW8	5/50	5,00	5,30
10292029 31	10294029 31	29-31	20	12 Nm	35 Bar	SW11	2/50	5,50	6,10
10292031 34	10294031 34	31-34	20	12 Nm	35 Bar	SW11	2/50	5,90	6,20
10292034 37	10294034 37	34-37	20	12 Nm	35 Bar	SW11	2/50	6,00	6,20
10292037 40	10294037 40	37-40	20	12 Nm	35 Bar	SW11	2/50	6,20	6,50
10292040 43	10294040 43	40-43	20	12 Nm	35 Bar	SW11	2/50	6,20	6,50
10292043 47	10294043 47	43-47	20	12 Nm	35 Bar	SW11	2/50	7,60	10,60
10292047 51	10294047 51	47-51	20	16 Nm	30 Bar	SW11	2/50	7,60	10,60
10292051 55	10294051 55	51-55	20	16 Nm	30 Bar	SW11	2/25	8,00	10,90
10292055 59	10294055 59	55-59	20	16 Nm	30 Bar	SW11	2/25	8,00	10,90
10292059 63	10294059 63	59-63	20	16 Nm	30 Bar	SW11	2/25	8,00	10,90
10292063 68	10294063 68	63-68	20	16 Nm	30 Bar	SW11	2/25	8,00	11,30
10292068 73	10294068 73	68-73	25	30 Nm	20 Bar	SW13	1/25	11,30	12,30
10292073 79	10294073 79	73-79	25	30 Nm	20 Bar	SW13	1/25	11,60	12,70
10292079 85	10294079 85	79-85	25	30 Nm	20 Bar	SW13	1/25	11,60	12,80
10292085 91	10294085 91	85-91	25	30 Nm	15 Bar	SW13	1/25	12,80	12,90
10292091 97	10294091 97	91-97	25	30 Nm	15 Bar	SW13	1/25	12,80	12,90
10292097 104	10294097 104	97-104	25	30 Nm	15 Bar	SW13	1/25	12,80	13,00
10292104 112	10294104 112	104-112	25	30 Nm	10 Bar	SW13	1/25	12,80	13,30
10292112 121	10294112 121	112-121	25	30 Nm	10 Bar	SW13	1/25	13,20	14,30
10292121 130	10294121 130	121-130	25	30 Nm	10 Bar	SW13	1/25	13,50	14,30
10292130 140	10294130 140	130-140	28	45 Nm	6 Bar	SW15	1/10	16,60	19,30
10292140 150	10294140 150	140-150	28	45 Nm	6 Bar	SW15	1/10	18,80	24,90
10292150 162	10294150 162	150-162	28	45 Nm	6 Bar	SW15	1/10	19,30	25,50
10292162 174	10294162 174	162-174	28	45 Nm	3 Bar	SW15	1/10	19,50	25,50
10292174 187	10294174 187	174-187	28	45 Nm	3 Bar	SW15	1/10	19,80	25,50
10292187 200	10294187 200	187-200	28	45 Nm	3 Bar	SW15	1/10	20,20	25,50
10292200 213	10294200 213	200-213	28	45 Nm	3 Bar	SW15	1/10	21,30	25,50
10292213 226	10294213 226	213-226	28	45 Nm	3 Bar	SW15	1/10	21,30	25,50
10292226 239	10294226 239	226-239	28	45 Nm	3 Bar	SW15	1/10	21,30	26,70
10292239 252	10294239 252	239-252	28	45 Nm	3 Bar	SW15	1/10	21,40	26,70



Schrauben in SB-Verpackungen

Screws in self-service packages

Visserie sous blister en libre service

Kapitel 11

Chapter 11



A2 - Schrauben in SB-Verpackungen

AISI 304 - Screws in selfservice packages

AISI 304 - Visserie sous blister en libre service



A4 - Schrauben in SB-Verpackungen

AISI 316 - Screws in selfservice packages

AISI 316 - Visserie sous blister en libre service



DE
EN
FR



In drei Sprachen erhältlich!

Available in three languages!!

Disponible en trois langues!



Den Marinetch Fastener Finder gibt es im praktischen

Taschenformat –

als wertvolle Entscheidungshilfe für Ihren Point-of-Sale, als Messhilfe für unterwegs oder als praktisches Kundengeschenk.

Gleich bestellen!

Art-No.: MT-FastenerFinder-DE

The Marinetch Fastener Finder is available in a practical pocket size – as a valuable decision-making aid for your point-of-sale, as a measuring aid for on the road or as a practical customer gift.

Order now! Art-No.: MT-FastenerFinder-EN

Le chercheur d'attaches Marinetch est disponible dans un format de poche pratique – comme une aide précieuse à la décision dans votre point de vente, comme une aide à la mesure pour la route ou comme un cadeau pratique pour le client.

Commandez maintenant!

Art-No.: MT-FastenerFinder-FR





Materialinfos, Abmessungen und Formen in der Übersicht

Material information, dimensions and shapes at a glance

Informations sur les matériaux, dimensions et formes dans la vue d'ensemble

Kopfformen

Types of head

Types de tête

-  **Zylinderkopf**
Socket head
Tête cylindrique
-  **Flachrundkopf**
Mushroom head
Tête plate ronde
-  **Sechskantkopf**
Hexagon head
Tête hexagonale
-  **Linsenkopf**
Pan head
Tête bombée
-  **Linsensenkkopf**
Raised countersunk head
Tête fraisée bombée fendues
-  **Senkkopf**
Countersunk head
Tête fraisée

Ab hier wird gemessen





Measuring starts from here

La mesure commence ici

Antriebsformen

Types of drive

Types d'entraînement

-  **Schlitz**
Slotted screw
Fente
-  **Kreuzschlitz Philips (PH)**
Cross-head Philips drive (PH)
Cruciforme Philips (PH)
-  **Kreuzschlitz Pozi (PZ)**
Cross-head Pozi drive (PZ)
Cruciforme Pozi (PZ)
-  **Innenvielzahn TX**
Innensechsrund
Internal serration TX hexalobular
Empreinte TX
-  **Innensechskant**
Hexagon socket
Hexagone interne
-  **Außensechskant**
External hexagon
Hexagone externe

Gewindearten

Thread types

Types de filetage

-  **Metrisches Gewinde**
Metric thread
Filetage métrique
-  **Blechgewinde**
Tapping thread
Filetage de tôle
-  **Holzgewinde**
Wood thread
Filetage de bois

U-Scheiben finden

Washer finder

Trouvez les rondelles

DIN 125

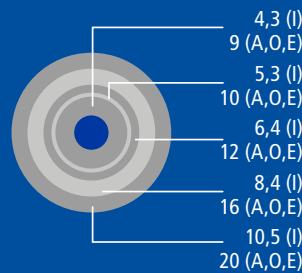

DIN 9021

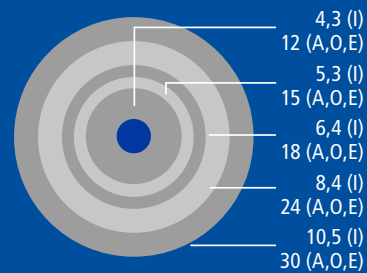

Durchmesser in mm: innen (I) und außen (A) Diameter in mm: inside (I) and outside (O)
Diamètre en mm: intérieur (I) et extérieur (E)

Marinetch Produkt-Blisterkarten

Marinetch product blister cards

Marinetch cartes blister de produits

Point of sale

Das ganze Marinetch-Sortiment ansprechend geblistert

Sauber aufgehängt und gut präsentiert: Konfektionierte Produkt-Blisterkarten mit Euro-Standard Lochung für die erfolgreiche Produktplatzierung am Point of Sale. Ihre Vorteile: Einfache Handhabung und schnelle Bestückung Ihrer Verkaufswände. Alle relevanten Produktinfos befinden sich auf der Karte, wie EAN-Code, Artikelbeschreibung, Artikelnummer, Rostfrei-Label, Duales System Label. Alle unsere Artikel sind geblistert erhältlich – ab Stückzahl 1!

Sie möchten Marinetch-Artikel im eigenen Design präsentieren? Kein Problem, wir erstellen die Blisterkarten nach Ihren Gestaltungsvorgaben! **Gern beraten wir Sie telefonisch dazu!**



The whole Marinetch range attractively blistered

Cleanly hung and well presented: Ready-made product blister cards with Euro standard perforation for successful product placement at the point of sale. Your advantages: Easy handling and fast loading of your sales walls. All relevant product information is on the card, such as EAN code, article description, article number, stainless steel label. All our articles are available in blister packs – starting at 1 piece! You want to present Marinetch articles in your own design? No problem, we will create the blister cards according to your design specifications! **We will gladly advise you by telephone!**

Toute la gamme Marinetch est joliment boursoufflée

Bien accroché et bien présenté: Cartes blister de produits assemblés avec perforation aux normes européennes pour un placement de produit réussi sur le point de vente. Vos avantages: Manipulation facile et montage rapide de vos murs de vente. Toutes les informations pertinentes sur le produit figurent sur la carte, telles que le code EAN, la description de l'article, le numéro de l'article, l'étiquette en acier inoxydable. Tous nos articles sont disponibles sous blister – à partir de la quantité 1!

Vous voulez présenter des articles de Marinetch dans votre propre design ? Pas de problème, nous créons les cartes blisters selon vos spécifications de conception! **Nous vous conseillons volontiers par téléphone!**

Toda la gama Marinetch atractivamente ampollada

Colocados de forma limpia y bien presentados: Tarjetas de blister de producto ya preparadas con perforación euroestándar para colocar el producto con éxito en el punto de venta. Sus ventajas: Fácil manejo y carga rápida de sus paredes de venta. Toda la información relevante del producto está en la tarjeta, como el código EAN, la descripción del artículo, el número de artículo y la etiqueta de acero inoxidable. Todos nuestros artículos están disponibles en blísteres - ¡a partir de 1 unidad! ¿Quiere presentar los artículos de Marinetch con su propio diseño? No hay problema, ¡creamos los blísteres según las especificaciones de su diseño! **Estaremos encantados de asesorarle por teléfono.**

Cała gama Marinetch atrakcyjnie zablistowana

Czysto zawieszono i dobrze zaprezentowane: Gotowe karty blistrowe produktów z perforacją w standardzie Euro dla skutecznego umieszczenia produktu w punkcie sprzedaży. Państwa zalety: Łatwa obsługa i szybkie ładowanie Twoich ścian sprzedażowych. Wszystkie istotne informacje o produkcie znajdują się na karcie, takie jak kod EAN, opis artykułu, numer artykułu, etykieta ze stali nierdzewnej. Wszystkie nasze artykuły dostępne są w opakowaniach typu blister - już od 1 sztuki! Chcesz zaprezentować artykuły Marinetch w swoim własnym projekcie? Nie ma problemu, stworzymy karty blistrowe według specyfikacji Twojego projektu! **Chętnie doradzimy Ci telefonicznie!**

Die Marinetech Blisterwand

The Marinetech blister wall

Le Marinetech mur de blister



Das Blisterwand-System für Ihre Verkaufsausstellung

Einfach gut in Szene gesetzt: Die Marinetech Blisterwand präsentiert das ganze Produkt-Sortiment attraktiv und übersichtlich. Das Wandsystem ist in diversen Größen und Ausführungen verfügbar und damit beliebig erweiterbar. Wählen Sie alle Artikel für Ihre Blisterwand individuell aus oder entscheiden Sie sich für das Marinetech-Standardsortiment. Wir beraten Sie gern dazu! Natürlich erstellen wir das Blisterwand-System auch in Ihrem Corporate Design bzw. nach Ihren Gestaltungsvorgaben.



Modul sind einfach erweiterbar

Modules easily extendable

Modules facilement extensible

Módulos fácilmente ampliable

Moduły z możliwością łatwej rozbudowy

MT-Display "kompakt" Seite 528
MT display "compact" page 529



The blister wall system for your sales exhibition

Simply well set in scene: The Marinetech blister wall presents the entire product range attractively and clearly. The wall system consists of modules, each 125 cm wide, including head rail and can be extended as required. Select all the items for your blister wall individually or opt for the Marinetech standard range. We will be happy to advise you! Of course we can also create the blister wall system in your corporate design or according to your design specifications.



Le système de cloisonnement pour votre exposition de vente

Simplement bien mis en scène: Le mur blister Marinetech présente toute la gamme de produits de manière attrayante et claire. Le système de mur se compose de modules de 125 cm de large chacun, y compris le rail de tête, et peut être étendu selon les besoins. Sélectionnez individuellement tous les articles pour votre paroi de blister ou optez pour la gamme standard Marinetech. Nous serons heureux de vous conseiller! Bien entendu, nous pouvons également créer le système de murs-coques dans le design de votre entreprise ou selon vos spécifications de conception.



El sistema de paredes blíster para su exposición de ventas

Simplemente bien ambientado: La pared de blíster de Marinetech presenta toda la gama de productos de forma atractiva y clara. El sistema de pared se compone de módulos de 125 cm de ancho cada uno, incluida la barandilla, y puede ampliarse según las necesidades. Seleccione todos los artículos para su pared de blíster de forma individual u opte por la gama estándar de Marinetech. Estaremos encantados de asesorarle. Por supuesto, también podemos crear el sistema de pared blíster con su diseño corporativo o según sus especificaciones de diseño.



System ścianek blisterowych dla Państwa ekspozycji handlowej

Po prostu dobrze osadzona w scenarii: Ścianka blistrowa Marinetech prezentuje cały asortyment produktów atrakcyjnie i wyraźnie. System ścianek składa się z modułów, każdy o szerokości 125 cm, łącznie z szyną czołową i może być dowolnie rozbudowywany. Wybierz wszystkie elementy do swojej ścianki blisterowej indywidualnie lub zdecyduj się na standardowy asortyment Marinetech. Chętnie doradzimy! Oczywiście możemy również stworzyć system ścianki blister w Twoim firmowym projekcie lub według Twojej specyfikacji projektowej.



🇩🇪 A2 Schrauben-Verkaufsstander bestückt

- Exklusiver, drehbarer Verkaufsstander. Grundfläche: 1 m², Höhe: 2,20m
- 245 verschiedene, gängige Schraubenabmessungen auf engstem Raum
- Keine unterschiedlichen Preisgruppen im EK- und VK-Preis
- Jede Verpackung mit Sichtfenster und Produktabbildung, EAN-Code

🇬🇧 Display for screws A2 completely equipped

- Exclusive rotating display with a base area of only 1 m² and a height of 2.20m
- 245 different and common screw dimensions displayed
- No different cost price and sales categories
- Each package with window and product illustration, EAN-code

🇫🇷 Affichage pour vis A2 complètement équipé

- Stand de vente exclusif et rotatif d'une surface de 1 m² seulement et d'une hauteur de 2,20m
- 245 dimensions de vis différentes et communes dans un espace très réduit
- Pas de groupes de prix différents dans les prix de la CE et du Royaume-Uni
- Chaque paquet avec fenêtre de visualisation et illustration du produit, Code EAN



Einfache Nachbestellung
im 10er-Karton.
Preis auf Anfrage.

Simple repeat order in
cartons of 10.
Price on demand.

Commande facile en
boîte de 10.
Prix sur demande.

800002SB

Bestückungsvarianten
Variants of equipment
Variantes d'équipement

Seite	Schrauben/Screws/Vis	Seite	Schrauben/Screws/Vis	Seite	Scheiben/Washers/Rondelles
445	DIN 84	458	DIN 95	464	DIN 125
446	DIN 963	458	DIN 97	464	DIN 127
447	DIN 964	459	Art.-Nr. 9049	464	Art.-Nr. 1011
448	DIN 965 ISO 14581	459	Art.-Nr. 9048	465	DIN 9021
449	DIN 966 ISO 14584	460	Art.-Nr. 9047	465	DIN 6799
450	DIN 7985 ISO 14583	460	DIN 571	Sonstiges/Others/Autre	
451	DIN 933	461	Art.-Nr. 1005	466	DIN 3017
452	DIN 912 ISO 14579	Mutter/Nuts/Ecrous		467	DIN 94
453	DIN 603	462	DIN 934	467	Art.-Nr. 1014
454	ISO 10642	462	DIN 985		
455	DIN 7981 ISO 14585	462	DIN 1587		
456	DIN 7982 ISO 14586	463	DIN 315		
457	DIN 7983 ISO 14587	463	Art.-Nr. 1004		

A2/AISI-304 Schrauben in SB-Verpackungen

Screws in self-service packages
Visserie sous blister en libre service

11



Blister Pack DIN 84 + DIN 934 / A2-AISI 304
Zylinderschraube mit Schlitz und Mutter
Slotted cheese head screw with nut

DIN 84

Standard- bestückung Standard equipment	DIN Artikel-Nr. Item-no.	Abmessungen Dimensions	Inhalt Blister Box Pcs. Blister Box	VE** PU**	Preis*/Blisterbox Price*/Blister Box
Ja/Yes	8008423 10	M3x10	10	10	3,20
Ja/Yes	8008423 16	M3x16	10	10	3,20
Ja/Yes	8008423 20	M3x20	8	10	3,20
Ja/Yes	8008424 16	M4x16	8	10	3,20
Ja/Yes	8008424 20	M4x20	8	10	3,20
Ja/Yes	8008424 30	M4x30	6	10	3,20
Ja/Yes	8008424 40	M4x40	6	10	3,20
Nein/No	8008425 16	M5x16	6	10	3,20
Ja/Yes	8008425 20	M5x20	6	10	3,20
Ja/Yes	8008425 30	M5x30	6	10	3,20
Ja/Yes	8008425 40	M5x40	4	10	3,20
Ja/Yes	8008425 50	M5x50	4	10	3,20
Ja/Yes	8008426 20	M6x20	4	10	3,20
Ja/Yes	8008426 30	M6x30	4	10	3,20
Ja/Yes	8008426 40	M6x40	4	10	3,20
Nein/No	8008426 50	M6x50	4	10	3,20
Ja/Yes	8008426 60	M6x60	4	10	3,20
Nein/No	8008428 30	M8x30	4	10	3,20
Nein/No	8008428 40	M8x40	4	10	3,20
Ja/Yes	8008428 60	M8x60	2	10	3,20
Ja/Yes	8008428 80	M8x80	2	10	3,20
Ja/Yes	8008428 100	M8x100	2	10	3,20

11

DIN 963

Blister Pack DIN 84 + DIN 934 / A2-AISI 304

Zylinderschraube mit Schlitz und Mutter
Slotted cheese head screw with nut



Standard- bestückung Standard equipment	DIN Artikel-Nr. Item-no.	Abmessungen Dimensions	Inhalt Blister Box Pcs. Blister Box	VE** PU**	Preis*/Blisterbox Price*/Blister Box
Ja/Yes	8096323 10	M3x10	10	10	3,20
Ja/Yes	8096323 16	M3x16	10	10	3,20
Ja/Yes	8096323 20	M3x20	8	10	3,20
Ja/Yes	8096324 16	M4x16	8	10	3,20
Ja/Yes	8096324 20	M4x20	8	10	3,20
Ja/Yes	8096324 30	M4x30	6	10	3,20
Ja/Yes	8096324 40	M4x40	6	10	3,20
Ja/Yes	8096325 16	M5x16	6	10	3,20
Ja/Yes	8096325 20	M5x20	6	10	3,20
Ja/Yes	8096325 30	M5x30	6	10	3,20
Ja/Yes	8096325 40	M5x40	4	10	3,20
Ja/Yes	8096325 50	M5x50	4	10	3,20
Nein/No	8096326 16	M6x16	4	10	3,20
Ja/Yes	8096326 20	M6x20	4	10	3,20
Ja/Yes	8096326 30	M6x30	4	10	3,20
Ja/Yes	8096326 40	M6x40	4	10	3,20
Ja/Yes	8096326 50	M6x50	4	10	3,20
Ja/Yes	8096326 60	M6x60	4	10	3,20
Ja/Yes	8096328 40	M8x40	4	10	3,20
Nein/No	8096328 60	M8x60	2	10	3,20
Ja/Yes	8096328 80	M8x80	2	10	3,20
Ja/Yes	8096328 100	M8x100	2	10	3,20
Ja/Yes	8008428 100	M8x100	2	10	3,20

A2/AISI-304 Schrauben in SB-Verpackungen

Screws in self-service packages
Visserie sous blister en libre service

11



Blister Pack DIN 964 + DIN 934 / A2-AISI 304
Linsensenk schraube mit Schlitz und Mutter
Slotted raised countersunk head screw with nut

DIN 964

Standard- bestückung Standard equipment	DIN Artikel-Nr. Item-no.	Abmessungen Dimensions	Inhalt Blister Box Pcs. Blister Box	VE** PU**	Preis*/Blisterbox Price*/Blister Box
Ja/Yes	8096423 10	M3x10	10	10	3,20
Ja/Yes	8096423 16	M3x16	10	10	3,20
Ja/Yes	8096423 20	M3x20	8	10	3,20
Ja/Yes	8096424 16	M4x16	8	10	3,20
Ja/Yes	8096424 20	M4x20	8	10	3,20
Nein/No	8096424 25	M4x25	6	10	3,20
Ja/Yes	8096424 30	M4x30	6	10	3,20
Ja/Yes	8096424 40	M4x40	6	10	3,20
Ja/Yes	8096425 16	M5x16	6	10	3,20
Ja/Yes	8096425 20	M5x20	4	10	3,20
Ja/Yes	8096425 30	M5x30	4	10	3,20
Ja/Yes	8096425 40	M5x40	4	10	3,20
Ja/Yes	8096425 50	M5x50	4	10	3,20
Ja/Yes	8096426 20	M6x20	4	10	3,20
Ja/Yes	8096426 30	M6x30	4	10	3,20
Ja/Yes	8096426 40	M6x40	4	10	3,20
Ja/Yes	8096426 50	M6x50	4	10	3,20
Ja/Yes	8096426 60	M6x60	4	10	3,20
Ja/Yes	8096428 60	M8x60	2	10	3,20
Ja/Yes	8096428 80	M8x80	2	10	3,20
Ja/Yes	8096428 100	M8x100	2	10	3,20
Ja/Yes	8008428 100	M8x100	2	10	3,20

11

DIN 965
ISO 14581
Blister Pack DIN 965 + DIN 934 / A2-AISI 304

 Senkschraube mit Mutter
 Countersunk head screw with nut

DIN 965

ISO 14581



Standard- bestückung Standard equipment	DIN Artikel-Nr. Item-no.	ISO Artikel-Nr. Item-no.	Abmessungen Dimensions	DIN Antrieb DIN Drive	ISO Antrieb DIN Drive	Inhalt Blister Box Pcs. Blister Box	VE** PU**	Preis*/Blisterbox Price*/Blister Box
Nein/No	8096523 10	81458123 10	M3x10	PH2	TX10	10	10	3,20
Nein/No	8096523 16	81458123 16	M3x16	PH2	TX10	10	10	3,20
Nein/No	8096523 20	81458123 20	M3x20	PH2	TX10	8	10	3,20
Nein/No	8096524 16	81458124 16	M4x16	PH2	TX20	8	10	3,20
Nein/No	8096524 20	81458124 20	M4x20	PH2	TX20	8	10	3,20
Nein/No	8096524 30	81458124 30	M4x30	PH2	TX20	6	10	3,20
Nein/No	8096524 40	81458124 40	M4x40	PH2	TX20	6	10	3,20
Nein/No	8096524 50	81458124 50	M4x50	PH2	TX20	4	10	3,20
Nein/No	8096524 60	81458124 60	M4x60	PH2	TX20	4	10	3,20
Nein/No	8096525 16	81458125 16	M5x16	PH3	TX25	6	10	3,20
Nein/No	8096525 20	81458125 20	M5x20	PH3	TX25	4	10	3,20
Nein/No	8096525 30	81458125 30	M5x30	PH3	TX25	4	10	3,20
Nein/No	8096525 40	81458125 40	M5x40	PH3	TX25	4	10	3,20
Nein/No	8096525 50	81458125 50	M5x50	PH3	TX25	4	10	3,20
Nein/No	8096525 60	81458125 60	M5x60	PH3	TX25	4	10	3,20
Nein/No	8096525 80	81458125 80	M5x80	PH3	TX25	4	10	3,20
Nein/No	8096526 20	81458126 20	M6x20	PH3	TX30	4	10	3,20
Nein/No	8096526 30	81458126 30	M6x30	PH3	TX30	4	10	3,20
Nein/No	8096526 40	81458126 40	M6x40	PH3	TX30	4	10	3,20
Nein/No	8096526 50	81458126 50	M6x50	PH3	TX30	4	10	3,20
Nein/No	8096526 60	81458126 60	M6x60	PH3	TX30	4	10	3,20
Nein/No	8096526 80	81458126 80	M6x80	PH3	TX30	4	10	3,20
Nein/No	8096528 40	81458128 40	M8x40	PH4	TX45	2	10	3,20
Nein/No	8096528 60	81458128 60	M8x60	PH4	TX45	2	10	3,20
Nein/No	8096528 80	81458128 80	M8x80	PH4	TX45	2	10	3,20

A2/AISI-304 Schrauben in SB-Verpackungen

Screws in self-service packages
Visserie sous blister en libre service

11

DIN 966

ISO 14584



Blister Pack DIN 966 + DIN 934 / A2-AISI 304

Linsensenschraube mit Mutter
Raised countersunk head screw with nut

DIN 966
ISO 14584

Standard- bestückung Standard equipment	DIN Artikel-Nr. Item-no.	ISO Artikel-Nr. Item-no.	Abmessungen Dimensions	DIN Antrieb DIN Drive	ISO Antrieb DIN Drive	Inhalt Blister Box Pcs. Blister Box	VE** PU**	Preis*/Blisterbox Price*/Blister Box
Nein/No	8096623 10	81458423 10	M3x10	PH2	TX10	10	10	3,20
Nein/No	8096623 16	81458423 16	M3x16	PH2	TX10	10	10	3,20
Nein/No	8096623 20	81458423 20	M3x20	PH2	TX10	8	10	3,20
Nein/No	8096624 16	81458424 16	M4x16	PH2	TX20	8	10	3,20
Nein/No	8096624 20	81458424 20	M4x20	PH2	TX20	8	10	3,20
Nein/No	8096624 30	81458424 30	M4x30	PH2	TX20	6	10	3,20
Nein/No	8096624 40	81458424 40	M4x40	PH2	TX20	6	10	3,20
Nein/No	8096624 60	81458424 60	M4x60	PH2	TX20	4	10	3,20
Nein/No	8096625 16	81458425 16	M5x16	PH3	TX25	6	10	3,20
Nein/No	8096625 20	81458425 20	M5x20	PH3	TX25	4	10	3,20
Nein/No	8096625 30	81458425 30	M5x30	PH3	TX25	4	10	3,20
Nein/No	8096625 40	81458425 40	M5x40	PH3	TX25	4	10	3,20
Nein/No	8096625 50	81458425 50	M5x50	PH3	TX25	4	10	3,20
Nein/No	8096625 80	81458425 80	M5x80	PH3	TX25	4	10	3,20
Nein/No	8096626 20	81458426 20	M6x20	PH3	TX30	4	10	3,20
Nein/No	8096626 30	81458426 30	M6x30	PH3	TX30	4	10	3,20
Nein/No	8096626 40	81458426 40	M6x40	PH3	TX30	4	10	3,20
Nein/No	8096626 50	81458426 50	M6x50	PH3	TX30	4	10	3,20
Nein/No	8096626 60	81458426 60	M6x60	PH3	TX30	4	10	3,20
Nein/No	8096628 40	81458428 40	M8x40	PH4	TX45	4	10	3,20
Nein/No	8096628 50	81458428 50	M8x50	PH4	TX45	2	10	3,20
Nein/No	8096628 60	81458428 60	M8x60	PH4	TX45	2	10	3,20
Nein/No	8096628 80	81458428 80	M8x80	PH4	TX45	2	10	3,20

11

DIN 7985
ISO 14583

Blister Pack DIN 7985 + DIN 934 / A2-AISI 304

Linsenschraube mit Mutter
Raised cheese head screw with nut

DIN 7985



ISO 14583



Standard- bestückung Standard equipment	DIN Artikel-Nr. Item-no.	ISO Artikel-Nr. Item-no.	Abmessungen Dimensions	DIN Antrieb DIN Drive	ISO Antrieb DIN Drive	Inhalt Blister Box Pcs. Blister Box	VE** PU**	Preis*/Blisterbox Price*/Blister Box
Nein/No	8798523 10	81458323 10	M3x10	PH1	TX10	10	10	3,20
Nein/No	8798523 16	81458323 16	M3x16	PH1	TX10	10	10	3,20
Nein/No	8798523 20	81458323 20	M3x20	PH1	TX10	8	10	3,20
Nein/No	8798524 16	81458324 16	M4x16	PH2	TX20	8	10	3,20
Nein/No	8798524 20	81458324 20	M4x20	PH2	TX20	8	10	3,20
Nein/No	8798524 30	81458324 30	M4x30	PH2	TX20	6	10	3,20
Nein/No	8798524 40	81458324 40	M4x40	PH2	TX20	6	10	3,20
Nein/No	8798524 60	81458324 60	M4x60	PH2	TX20	4	10	3,20
Nein/No	8798525 20	81458325 20	M5x20	PH2	TX25	6	10	3,20
Nein/No	8798525 30	81458325 30	M5x30	PH2	TX25	6	10	3,20
Nein/No	8798525 40	81458325 40	M5x40	PH2	TX25	4	10	3,20
Nein/No	8798525 50	81458325 50	M5x50	PH2	TX25	4	10	3,20
Nein/No	8798525 80	81458325 80	M5x80	PH2	TX25	4	10	3,20
Nein/No	8798526 20	81458326 20	M6x20	PH3	TX30	4	10	3,20
Nein/No	8798526 30	81458326 30	M6x30	PH3	TX30	4	10	3,20
Nein/No	8798526 40	81458326 40	M6x40	PH3	TX30	4	10	3,20
Nein/No	8798526 60	81458326 60	M6x60	PH3	TX30	4	10	3,20
Nein/No	8798526 80	81458326 80	M6x80	PH3	TX30	2	10	3,20
Nein/No	8798528 40	81458328 40	M8x40	PH4	TX45	4	10	3,20
Nein/No	8798528 60	81458328 60	M8x60	PH4	TX45	2	10	3,20
Nein/No	8798528 80	81458328 80	M8x80	PH4	TX45	2	10	3,20

A2/AISI-304 Schrauben in SB-Verpackungen

Screws in self-service packages
Visserie sous blister en libre service

11



Blister Pack DIN 933 + DIN 934 / A2-AISI 304
Sechskantschraube mit Mutter
Hexagon head screw with nut

DIN 933

Standard- bestückung Standard equipment	DIN Artikel-Nr. Item-no.	Abmessungen Dimensions	DIN Antrieb DIN Drive	Inhalt Blister Box Pcs. Blister Box	VE** PU**	Preis*/Blisterbox Price*/Blister Box
Nein/No	8093324 16	M4x16	SW7	8	10	3,20
Nein/No	8093324 20	M4x20	SW7	8	10	3,20
Nein/No	8093324 25	M4x25	SW7	6	10	3,20
Nein/No	8093324 30	M4x30	SW7	6	10	3,20
Ja/Yes	8093325 16	M5x16	SW8	8	10	3,20
Ja/Yes	8093325 20	M5x20	SW8	8	10	3,20
Ja/Yes	8093325 25	M5x25	SW8	6	10	3,20
Ja/Yes	8093325 30	M5x30	SW8	6	10	3,20
Ja/Yes	8093325 40	M5x40	SW8	6	10	3,20
Ja/Yes	8093325 50	M5x50	SW8	4	10	3,20
Nein/No	8093325 80	M5x80	SW8	4	10	3,20
Ja/Yes	8093326 20	M6x20	SW10	6	10	3,20
Ja/Yes	8093326 25	M6x25	SW10	6	10	3,20
Ja/Yes	8093326 30	M6x30	SW10	4	10	3,20
Ja/Yes	8093326 40	M6x40	SW10	4	10	3,20
Nein/No	8093326 50	M6x50	SW10	4	10	3,20
Nein/No	8093326 60	M6x60	SW10	4	10	3,20
Nein/No	8093326 80	M6x80	SW10	2	10	3,20
Nein/No	8093328 20	M8x20	SW13	4	10	3,20
Nein/No	8093328 25	M8x25	SW13	4	10	3,20
Ja/Yes	8093328 30	M8x30	SW13	4	10	3,20
Ja/Yes	8093328 40	M8x40	SW13	4	10	3,20
Ja/Yes	8093328 50	M8x50	SW13	2	10	3,20
Ja/Yes	8093328 60	M8x60	SW13	2	10	3,20
Nein/No	8093328 70	M8x70	SW13	2	10	3,20
Ja/Yes	8093328 80	M8x80	SW13	2	10	3,20
Ja/Yes	8093328 100	M8x100	SW13	2	10	3,20
Nein/No	80933210 40	M10x40	SW17	2	10	3,20
Nein/No	80933210 60	M10x60	SW17	2	10	3,20
Nein/No	80933210 80	M10x80	SW17	1	10	3,20
Nein/No	80933210 100	M10x100	SW17	1	10	3,20

11

DIN 912
ISO 14579
Blister Pack DIN 912 + DIN 934 / A2-AISI 304
 Zylinderschraube mit Mutter
 Hexagon socket head cap screw with nut

DIN 912



ISO 14579



Standard- bestückung Standard equipment	DIN Artikel-Nr. Item-no.	ISO Artikel-Nr. Item-no.	Abmessungen Dimensions	DIN Antrieb DIN Drive	ISO Antrieb DIN Drive	Inhalt Blister Box Pcs. Blister Box	VE** PU**	Preis*/Blisterbox Price*/Blister Box
Nein/No	8091223 10	81457923 10	M3x10	SW2,5	TX10	10	10	3,20
Nein/No	8091223 12	81457923 12	M3x12	SW2,5	TX10	10	10	3,20
Nein/No	8091223 20	81457923 20	M3x20	SW2,5	TX10	8	10	3,20
Nein/No	8091224 16	81457924 16	M4x16	SW3	TX20	8	10	3,20
Nein/No	8091224 20	81457924 20	M4x20	SW3	TX20	8	10	3,20
Nein/No	8091224 30	81457924 30	M4x30	SW3	TX20	6	10	3,20
Nein/No	8091224 40	81457924 40	M4x40	SW3	TX20	6	10	3,20
Nein/No	8091224 50	81457924 50	M4x50	SW3	TX20	4	10	3,20
Nein/No	8091224 60	81457924 60	M4x60	SW3	TX20	4	10	3,20
Nein/No	8091225 16	81457925 16	M5x16	SW4	TX25	6	10	3,20
Nein/No	8091225 20	81457925 20	M5x20	SW4	TX25	6	10	3,20
Nein/No	8091225 30	81457925 30	M5x30	SW4	TX25	6	10	3,20
Nein/No	8091225 40	81457925 40	M5x40	SW4	TX25	4	10	3,20
Nein/No	8091225 50	81457925 50	M5x50	SW4	TX25	4	10	3,20
Nein/No	8091225 60	81457925 60	M5x60	SW4	TX25	4	10	3,20
Nein/No	8091225 80	–	M5x80	SW4	TX25	4	10	3,20
Nein/No	8091226 20	81457926 20	M6x20	SW5	TX30	4	10	3,20
Nein/No	8091226 30	81457926 30	M6x30	SW5	TX30	4	10	3,20
Nein/No	8091226 40	81457926 40	M6x40	SW5	TX30	4	10	3,20
Nein/No	8091226 50	81457926 50	M6x50	SW5	TX30	4	10	3,20
Nein/No	8091226 60	81457926 60	M6x60	SW5	TX30	4	10	3,20
Nein/No	8091226 80	–	M6x80	SW5	TX30	2	10	3,20
Nein/No	8091228 20	81457928 20	M8x20	SW6	TX45	4	10	3,20
Nein/No	8091228 30	81457928 30	M8x30	SW6	TX45	4	10	3,20
Nein/No	8091228 40	81457928 40	M8x40	SW6	TX45	4	10	3,20
Nein/No	8091228 50	81457928 50	M8x50	SW6	TX45	2	10	3,20
Nein/No	8091228 60	81457928 60	M8x60	SW6	TX45	2	10	3,20
Nein/No	8091228 80	81457928 80	M8x80	SW6	TX45	2	10	3,20
Nein/No	8091228 100	–	M8x100	SW6	–	2	10	3,20

A2/AISI-304 Schrauben in SB-Verpackungen

Screws in self-service packages
Visserie sous blister en libre service

11



Blister Pack DIN 603 + DIN 934 / A2-AISI 304
Flachrundschaube mit Vierkantansatz und Mutter
Mushroom head square neck bolt with nut

DIN 603

Standard- bestückung Standard equipment	DIN Artikel-Nr. Item-no.	Abmessungen Dimensions	Inhalt Blister Box Pcs. Blister Box	VE** PU**	Preis*/Blisterbox Price*/Blister Box
Nein/No	8060326 20	M6x20	4	10	3,20
Ja/Yes	8060326 25	M6x25	4	10	3,20
Ja/Yes	8060326 30	M6x30	4	10	3,20
Ja/Yes	8060326 40	M6x40	4	10	3,20
Ja/Yes	8060326 50	M6x50	4	10	3,20
Ja/Yes	8060326 60	M6x60	2	10	3,20
Nein/No	8060328 20	M8x20	2	10	3,20
Nein/No	8060328 25	M8x25	2	10	3,20
Nein/No	8060328 30	M8x30	2	10	3,20
Ja/Yes	8060328 40	M8x40	2	10	3,20
Nein/No	8060328 50	M8x50	2	10	3,20
Ja/Yes	8060328 60	M8x60	2	10	3,20
Ja/Yes	8060328 70	M8x70	2	10	3,20
Ja/Yes	8060328 80	M8x80	2	10	3,20
Nein/No	8060328 100	M8x100	2	10	3,20

11

ISO 10642

Blister Pack ISO 10642 + DIN 934 / A2-AISI 304

Senkschraube mit Innensechskant mit Mutter
Hexagon socket countersunk head screw with nut



Standard- bestückung Standard equipment	ISO Artikel-Nr. Item-no.	Abmessungen Dimensions	ISO Antrieb DIN Drive	Inhalt Blister Box Pcs. Blister Box	VE** PU**	Preis*/Blisterbox Price*/Blister Box
Nein/No	81064223 10	M3x10	SW2	10	10	3,20
Nein/No	81064223 16	M3x16	SW2	10	10	3,20
Nein/No	81064223 20	M3x20	SW2	8	10	3,20
Nein/No	81064224 16	M4x16	SW2,5	8	10	3,20
Nein/No	81064224 20	M4x20	SW2,5	8	10	3,20
Nein/No	81064224 25	M4x25	SW2,5	6	10	3,20
Nein/No	81064224 30	M4x30	SW2,5	6	10	3,20
Nein/No	81064224 40	M4x40	SW2,5	6	10	3,20
Nein/No	81064224 60	M4x60	SW2,5	4	10	3,20
Nein/No	81064225 16	M5x16	SW3	6	10	3,20
Nein/No	81064225 20	M5x20	SW3	4	10	3,20
Nein/No	81064225 25	M5x25	SW3	6	10	3,20
Nein/No	81064225 30	M5x30	SW3	6	10	3,20
Nein/No	81064225 40	M5x40	SW3	4	10	3,20
Nein/No	81064225 50	M5x50	SW3	4	10	3,20
Nein/No	81064225 60	M5x60	SW3	4	10	3,20
Nein/No	81064225 80	M5x80	SW3	4	10	3,20
Nein/No	81064226 20	M6x20	SW4	4	10	3,20
Nein/No	81064226 25	M6x25	SW4	4	10	3,20
Nein/No	81064226 30	M6x30	SW4	4	10	3,20
Nein/No	81064226 40	M6x40	SW4	4	10	3,20
Nein/No	81064226 50	M6x50	SW4	4	10	3,20
Nein/No	81064226 60	M6x60	SW4	4	10	3,20
Nein/No	81064226 80	M6x80	SW4	2	10	3,20
Nein/No	81064228 20	M8x20	SW5	4	10	3,20
Nein/No	81064228 25	M8x25	SW5	4	10	3,20
Nein/No	81064228 30	M8x30	SW5	4	10	3,20
Nein/No	81064228 40	M8x40	SW5	4	10	3,20
Nein/No	81064228 50	M8x50	SW5	2	10	3,20
Nein/No	81064228 60	M8x60	SW5	2	10	3,20
Nein/No	81064228 70	M8x70	SW5	2	10	3,20
Nein/No	81064228 80	M8x80	SW5	2	10	3,20
Nein/No	81064228 100	M8x100	SW5	2	10	3,20

A2/AISI-304 Schrauben in SB-Verpackungen

Screws in self-service packages
Visserie sous blister en libre service

11

DIN 7981



ISO 14585



Blister Pack DIN 7981 / A2-AISI 304

Blechschrabe, Linsen Kopf

Tapping screw, pan head

DIN 7981
ISO 14585

Standard- bestückung Standard equipment	DIN Artikel-Nr. Item-no.	ISO Artikel-Nr. Item-no.	Abmessungen Dimensions	DIN Antrieb DIN Drive	ISO Antrieb DIN Drive	Inhalt Blister Box Pcs. Blister Box	VE** PU**	Preis*/Blisterbox Price*/Blister Box
Ja/Yes	87981229 95	814585229 95	2,9x9,5	PH1	TX10	20	10	3,20
Ja/Yes	87981229 13	814585229 13	2,9x13	PH1	TX10	20	10	3,20
Ja/Yes	87981229 16	814585229 16	2,9x16	PH1	TX10	20	10	3,20
Ja/Yes	87981235 13	814585235 13	3,5x13	PH2	TX15	15	10	3,20
Ja/Yes	87981235 16	814585235 16	3,5x16	PH2	TX15	12	10	3,20
Ja/Yes	87981235 19	814585235 19	3,5x19	PH2	TX15	12	10	3,20
Ja/Yes	87981235 25	814585235 25	3,5x25	PH2	TX15	12	10	3,20
Nein/No	87981235 32	814585235 32	3,5x32	PH2	TX15	10	10	3,20
Nein/No	87981235 38	814585235 38	3,5x38	PH2	TX15	10	10	3,20
Nein/No	87981239 22	–	3,9x22	PH2	–	12	10	3,20
Nein/No	87981239 25	–	3,9x25	PH2	–	12	10	3,20
Nein/No	87981239 32	–	3,9x32	PH2	–	10	10	3,20
Ja/Yes	87981242 13	814585242 13	4,2x13	PH2	TX20	12	10	3,20
Ja/Yes	87981242 16	814585242 16	4,2x16	PH2	TX20	12	10	3,20
Ja/Yes	87981242 19	814585242 19	4,2x19	PH2	TX20	12	10	3,20
Ja/Yes	87981242 25	814585242 25	4,2x25	PH2	TX20	10	10	3,20
Ja/Yes	87981242 32	814585242 32	4,2x32	PH2	TX20	10	10	3,20
Nein/No	87981242 38	814585242 38	4,2x38	PH2	TX20	10	10	3,20
Nein/No	87981242 45	814585242 45	4,2x45	PH2	TX20	5	10	3,20
Nein/No	87981242 50	814585242 50	4,2x50	PH2	TX20	4	10	3,20
Nein/No	87981242 60	814585242 60	4,2x60	PH2	TX20	4	10	3,20
Ja/Yes	87981248 13	814585248 13	4,8x13	PH2	TX25	10	10	3,20
Ja/Yes	87981248 19	814585248 19	4,8x19	PH2	TX25	10	10	3,20
Ja/Yes	87981248 25	814585248 25	4,8x25	PH2	TX25	10	10	3,20
Ja/Yes	87981248 32	814585248 32	4,8x32	PH2	TX25	6	10	3,20
Nein/No	87981248 38	814585248 38	4,8x38	PH2	TX25	6	10	3,20
Nein/No	87981248 45	814585248 45	4,8x45	PH2	TX25	5	10	3,20
Nein/No	87981248 50	814585248 50	4,8x50	PH2	TX25	4	10	3,20
Nein/No	87981248 60	814585248 60	4,8x60	PH2	TX25	4	10	3,20
Ja/Yes	87981255 16	814585255 16	5,5x16	PH3	TX25	6	10	3,20
Nein/No	87981255 19	814585255 19	5,5x19	PH3	TX25	6	10	3,20
Ja/Yes	87981255 25	814585255 25	5,5x25	PH3	TX25	6	10	3,20
Ja/Yes	87981255 32	814585255 32	5,5x32	PH3	TX25	6	10	3,20
Ja/Yes	87981255 38	814585255 38	5,5x38	PH3	TX25	6	10	3,20
Nein/No	87981255 45	814585255 45	5,5x45	PH3	TX25	5	10	3,20
Nein/No	87981255 50	814585255 50	5,5x50	PH3	TX25	4	10	3,20
Nein/No	87981255 60	814585255 60	5,5x60	PH3	TX25	4	10	3,20

11

DIN 7982
ISO 14586
Blister Pack DIN 7982 / A2-AISI 304

 Blechschraube, Senkkopf
 Tapping screw, countersunk head

DIN 7982



ISO 14586



Standard- bestückung Standard equipment	DIN Artikel-Nr. Item-no.	ISO Artikel-Nr. Item-no.	Abmessungen Dimensions	DIN Antrieb DIN Drive	ISO Antrieb DIN Drive	Inhalt Blister Box Pcs. Blister Box	VE** PU**	Preis*/Blisterbox Price*/Blister Box
Ja/Yes	87982229 95	814586229 95	2,9x9,5	PH1	TX10	20	10	3,20
Ja/Yes	87982229 13	814586229 13	2,9x13	PH1	TX10	20	10	3,20
Ja/Yes	87982229 16	814586229 16	2,9x16	PH1	TX10	20	10	3,20
Ja/Yes	87982235 13	814586235 13	3,5x13	PH2	TX15	15	10	3,20
Ja/Yes	87982235 16	814586235 16	3,5x16	PH2	TX15	12	10	3,20
Ja/Yes	87982235 19	814586235 19	3,5x19	PH2	TX15	12	10	3,20
Ja/Yes	87982235 25	814586235 25	3,5x25	PH2	TX15	12	10	3,20
Nein/No	87982235 32	814586235 32	3,5x32	PH2	TX15	10	10	3,20
Nein/No	87982235 38	814586235 38	3,5x38	PH2	TX15	10	10	3,20
Nein/No	87982239 13	814586239 13	3,9x13	PH2	TX15	12	10	3,20
Nein/No	87982239 16	814586239 16	3,9x16	PH2	TX15	12	10	3,20
Ja/Yes	87982242 13	814586242 13	4,2x13	PH2	TX20	12	10	3,20
Ja/Yes	87982242 16	814586242 16	4,2x16	PH2	TX20	12	10	3,20
Ja/Yes	87982242 19	814586242 19	4,2x19	PH2	TX20	12	10	3,20
Ja/Yes	87982242 25	814586242 25	4,2x25	PH2	TX20	10	10	3,20
Ja/Yes	87982242 32	814586242 32	4,2x32	PH2	TX20	10	10	3,20
Nein/No	87982242 38	814586242 38	4,2x38	PH2	TX20	10	10	3,20
Nein/No	87982242 45	814586242 45	4,2x45	PH2	TX20	5	10	3,20
Nein/No	87982242 50	814586242 50	4,2x50	PH2	TX20	4	10	3,20
Nein/No	87982242 60	814586242 60	4,2x60	PH2	TX20	4	10	3,20
Ja/Yes	87982248 13	814586248 13	4,8x13	PH2	TX25	10	10	3,20
Ja/Yes	87982248 19	814586248 19	4,8x19	PH2	TX25	10	10	3,20
Ja/Yes	87982248 25	814586248 25	4,8x25	PH2	TX25	10	10	3,20
Ja/Yes	87982248 32	814586248 32	4,8x32	PH2	TX25	6	10	3,20
Nein/No	87982248 45	814586248 45	4,8x45	PH2	TX25	5	10	3,20
Nein/No	87982248 60	814586248 60	4,8x60	PH2	TX25	4	10	3,20
Ja/Yes	87982255 16	814586255 16	5,5x16	PH3	TX25	6	10	3,20
Ja/Yes	87982255 25	814586255 25	5,5x25	PH3	TX25	6	10	3,20
Ja/Yes	87982255 32	814586255 32	5,5x32	PH3	TX25	6	10	3,20
Ja/Yes	87982255 38	814586255 38	5,5x38	PH3	TX25	6	10	3,20
Nein/No	87982255 45	814586255 45	5,5x45	PH3	TX25	5	10	3,20
Nein/No	87982255 50	814586255 50	5,5x50	PH3	TX25	5	10	3,20
Nein/No	87982255 60	814586255 60	5,5x60	PH3	TX25	4	10	3,20

A2/AISI-304 Schrauben in SB-Verpackungen

Screws in self-service packages
Visserie sous blister en libre service

11

DIN 7983

ISO 14587



Blister Pack DIN 7983 / A2-AISI 304
Blechschaube, Linsensenkkopf
Tapping screw, raised countersunk head

DIN 7983
ISO 14587

Standard- bestückung Standard equipment	DIN Artikel-Nr. Item-no.	ISO Artikel-Nr. Item-no.	Abmessungen Dimensions	DIN Antrieb DIN Drive	ISO Antrieb DIN Drive	Inhalt Blister Box Pcs. Blister Box	VE** PU**	Preis*/Blisterbox Price*/Blister Box
Ja/Yes	87983229 95	814587229 95	2,9x9,5	PH1	TX10	20	10	3,20
Ja/Yes	87983229 13	814587229 13	2,9x13	PH1	TX10	20	10	3,20
Ja/Yes	87983229 16	814587229 16	2,9x16	PH1	TX10	20	10	3,20
Ja/Yes	87983235 13	814587235 13	3,5x13	PH2	TX15	15	10	3,20
Ja/Yes	87983235 16	814587235 16	3,5x16	PH2	TX15	12	10	3,20
Ja/Yes	87983235 19	814587235 19	3,5x19	PH2	TX15	12	10	3,20
Ja/Yes	87983235 25	814587235 25	3,5x25	PH2	TX15	12	10	3,20
Nein/No	87983235 32	814587235 32	3,5x32	PH2	TX15	10	10	3,20
Nein/No	87983235 38	814587235 38	3,5x38	PH2	TX15	10	10	3,20
Ja/Yes	87983242 13	814587242 13	4,2x13	PH2	TX20	12	10	3,20
Ja/Yes	87983242 16	814587242 16	4,2x16	PH2	TX20	12	10	3,20
Ja/Yes	87983242 19	814587242 19	4,2x19	PH2	TX20	12	10	3,20
Ja/Yes	87983242 25	814587242 25	4,2x25	PH2	TX20	10	10	3,20
Ja/Yes	87983242 32	814587242 32	4,2x32	PH2	TX20	10	10	3,20
Nein/No	87983242 38	814587242 38	4,2x38	PH2	TX20	10	10	3,20
Nein/No	87983242 45	814587242 45	4,2x45	PH2	TX20	5	10	3,20
Nein/No	87983242 50	814587242 50	4,2x50	PH2	TX20	4	10	3,20
Nein/No	87983242 60	814587242 60	4,2x60	PH2	TX20	4	10	3,20
Ja/Yes	87983248 13	814587248 13	4,8x13	PH2	TX25	10	10	3,20
Ja/Yes	87983248 19	814587248 19	4,8x19	PH2	TX25	10	10	3,20
Ja/Yes	87983248 25	814587248 25	4,8x25	PH2	TX25	10	10	3,20
Ja/Yes	87983248 32	814587248 32	4,8x32	PH2	TX25	6	10	3,20
Nein/No	87983248 45	814587248 45	4,8x45	PH2	TX25	5	10	3,20
Nein/No	87983248 60	814587248 60	4,8x60	PH2	TX25	4	10	3,20
Ja/Yes	87983255 16	814587255 16	5,5x16	PH3	TX25	6	10	3,20
Ja/Yes	87983255 25	814587255 25	5,5x25	PH3	TX25	6	10	3,20
Ja/Yes	87983255 32	814587255 32	5,5x32	PH3	TX25	6	10	3,20
Ja/Yes	87983255 38	814587255 38	5,5x38	PH3	TX25	6	10	3,20
Nein/No	87983255 45	814587255 45	5,5x45	PH3	TX25	5	10	3,20
Nein/No	87983255 60	814587255 60	5,5x60	PH3	TX25	4	10	3,20

11

DIN 95

Blister Pack DIN 95 / A2-AISI 304

Linsensenk-Holzschraube mit Schlitz
Slotted raised countersunk head wood screw



Standard- bestückung Standard equipment	DIN Artikel-Nr. Item-no.	Abmessungen Dimensions	Inhalt Blister Box Pcs. Blister Box	VE** PU**	Preis*/Blisterbox Price*/Blister Box
Ja/Yes	80095225 12	2,5x12	10	10	3,20
Ja/Yes	80095225 16	2,5x16	10	10	3,20
Ja/Yes	80095230 12	3,0x12	10	10	3,20
Ja/Yes	80095230 16	3,0x16	10	10	3,20
Ja/Yes	80095230 20	3,0x20	10	10	3,20
Ja/Yes	80095230 25	3,0x25	8	10	3,20
Ja/Yes	80095230 30	3,0x30	8	10	3,20
Ja/Yes	80095240 20	4,0x20	8	10	3,20
Ja/Yes	80095240 30	4,0x30	6	10	3,20
Ja/Yes	80095240 40	4,0x40	6	10	3,20
Ja/Yes	80085240 50	4,0x50	4	10	3,20
Ja/Yes	80095250 30	5,0x30	4	10	3,20
Ja/Yes	80095250 40	5,0x40	4	10	3,20
Ja/Yes	80095250 50	5,0x50	4	10	3,20
Ja/Yes	80095250 60	5,0x60	4	10	3,20
Ja/Yes	80095260 60	6,0x60	2	10	3,20
Ja/Yes	80095260 70	6,0x70	2	10	3,20

DIN 97

Blister Pack DIN 97 / A2-AISI 304

Senk-Holzschraube mit Schlitz
Slotted countersunk head wood screw



Standard- bestückung Standard equipment	DIN Artikel-Nr. Item-no.	Abmessungen Dimensions	Inhalt Blister Box Pcs. Blister Box	VE** PU**	Preis*/Blisterbox Price*/Blister Box
Ja/Yes	8009723 12	3,0x12	10	10	3,20
Ja/Yes	8009723 16	3,0x16	10	10	3,20
Ja/Yes	8009723 20	3,0x20	10	10	3,20
Ja/Yes	8009723 25	3,0x25	8	10	3,20
Ja/Yes	8009723 30	3,0x30	8	10	3,20
Ja/Yes	8009724 20	4,0x20	8	10	3,20
Ja/Yes	8009724 30	4,0x30	6	10	3,20
Ja/Yes	8009724 40	4,0x40	6	10	3,20
Ja/Yes	8009724 50	4,0x50	6	10	3,20
Ja/Yes	8009725 30	5,0x30	4	10	3,20
Ja/Yes	8009725 40	5,0x40	4	10	3,20
Ja/Yes	8009725 50	5,0x50	4	10	3,20
Ja/Yes	8009725 60	5,0x60	4	10	3,20
Ja/Yes	8009726 60	6,0x60	2	10	3,20
Ja/Yes	8009726 70	6,0x70	2	10	3,20

A2/AISI-304 Schrauben in SB-Verpackungen

Screws in self-service packages
Visserie sous blister en libre service

11



Blister Pack Art.-Nr. 9049 / A2-AISI 304

Linsenkopf-Holzschraube mit mit verstärktem Kopf und Vollgewinde
Raised countersunk head timber screw with fullthread

Art.-Nr. 9049

Standard- bestückung Standard equipment	Artikel-Nr. Item-no.	Abmessungen Dimensions	Antrieb Drive	Inhalt Blister Box Pcs. Blister Box	VE** PU**	Preis*/Blisterbox Price*/Blister Box
Nein/No	89049230 20	3,0x20	PZ1	10	10	3,20
Nein/No	89049230 30	3,0x30	PZ1	8	10	3,20
Nein/No	89049240 20	4,0x20	PZ2	8	10	3,20
Nein/No	89049240 30	4,0x30	PZ2	8	10	3,20
Nein/No	89049240 40	4,0x40	PZ2	6	10	3,20
Nein/No	89049240 50	4,0x50	PZ2	6	10	3,20
Nein/No	89049250 40	5,0x40	PZ2	4	10	3,20
Nein/No	89049250 50	5,0x50	PZ2	4	10	3,20
Nein/No	89049250 60	5,0x60	PZ2	3	10	3,20
Nein/No	89049250 70	5,0x70	PZ2	3	10	3,20
Nein/No	89049260 40	6,0x40	PZ3	2	10	3,20
Nein/No	89049260 50	6,0x50	PZ3	2	10	3,20
Nein/No	89049260 60	6,0x60	PZ3	2	10	3,20
Nein/No	89049260 80	6,0x80	PZ3	2	10	3,20



Blister Pack Art.-Nr. 9048 / A2-AISI 304

Linsenkopf-Holzschraube mit verstärktem Kopf und Vollgewinde
Pan head timber screw with fullthread

Art.-Nr. 9048

Standard- bestückung Standard equipment	Artikel-Nr. Item-no.	Abmessungen Dimensions	Antrieb Drive	Inhalt Blister Box Pcs. Blister Box	VE** PU**	Preis*/Blisterbox Price*/Blister Box
Nein/No	89048230 20	3,0x20	PZ1	10	10	3,20
Nein/No	89048230 30	3,0x30	PZ1	8	10	3,20
Nein/No	89048240 20	4,0x20	PZ2	8	10	3,20
Nein/No	89048240 30	4,0x30	PZ2	8	10	3,20
Nein/No	89048240 40	4,0x40	PZ2	6	10	3,20
Nein/No	89048240 50	4,0x50	PZ2	6	10	3,20
Nein/No	89048250 40	5,0x40	PZ2	4	10	3,20
Nein/No	89048250 50	5,0x50	PZ2	4	10	3,20
Nein/No	89048250 60	5,0x60	PZ2	3	10	3,20
Nein/No	89048250 70	5,0x70	PZ2	3	10	3,20
Nein/No	89048260 40	6,0x40	PZ3	2	10	3,20
Nein/No	89048260 50	6,0x50	PZ3	2	10	3,20
Nein/No	89048260 60	6,0x60	PZ3	2	10	3,20
Nein/No	89048260 80	6,0x80	PZ3	2	10	3,20

11

**Art.-Nr.
9047**
Blister Pack Art.-Nr. 9047 / A2-AISI 304
 Senkkopf Holzschraube mit verstärktem Kopf und Teilgewinde
 Countersunk head timber screw with partial thread

Standard- bestückung Standard equipment	Artikel-Nr. Item-no.	Abmessungen Dimensions	Antrieb Drive	Inhalt Blister Box Pcs. Blister Box	VE** PU**	Preis*/Blisterbox Price*/Blister Box
Nein/No	89047245 40/24	4,5x40/24	TX20	4	10	3,20
Nein/No	89047245 45/30	4,5x45/30	TX20	4	10	3,20
Nein/No	89047245 50/30	4,5x50/30	TX20	4	10	3,20
Nein/No	89047245 60/35	4,5x60/35	TX20	2	10	3,20
Nein/No	89047245 70/42	4,5x70/42	TX20	2	10	3,20
Nein/No	89047245 80/50	4,5x80/50	TX20	2	10	3,20
Nein/No	89047250 40/24	5,0x40/24	TX25	4	10	3,20
Nein/No	89047250 45/30	5,0x45/30	TX25	4	10	3,20
Nein/No	89047250 50/30	5,0x50/30	TX25	4	10	3,20
Nein/No	89047250 60/35	5,0x60/35	TX25	2	10	3,20
Nein/No	89047250 70/40	5,0x70/40	TX25	2	10	3,20
Nein/No	89047250 80/50	5,0x80/50	TX25	2	10	3,20
Nein/No	89047250 90/60	5,0x90/60	TX25	2	10	3,20
Nein/No	89047250 100/60	5,0x100/60	TX25	2	10	3,20

DIN 571
Blister Pack DIN 571 / A2-AISI 304
 Sechskant-Holzschraube
 Hexagon head wood screw

Standard- bestückung Standard equipment	DIN Artikel-Nr. Item-no.	Abmessungen Dimensions	DIN Antrieb Drive	Inhalt Blister Box Pcs. Blister Box	VE** PU**	Preis*/Blisterbox Price*/Blister Box
Nein/No	8057126 40	6x40	SW10	4	10	3,20
Ja/Yes	8057126 50	6x50	SW10	4	10	3,20
Ja/Yes	8057126 60	6x60	SW10	4	10	3,20
Ja/Yes	8057126 70	6x70	SW10	2	10	3,20
Ja/Yes	8057126 80	6x80	SW10	2	10	3,20
Nein/No	8057128 40	8x40	SW13	4	10	3,20
Nein/No	8057128 50	8x50	SW13	2	10	3,20
Ja/Yes	8057128 60	8x60	SW13	2	10	3,20
Ja/Yes	8057128 70	8x70	SW13	2	10	3,20
Ja/Yes	8057128 80	8x80	SW13	2	10	3,20

A2/AISI-304 Schrauben in SB-Verpackungen

Screws in self-service packages
Visserie sous blister en libre service

11



Blister Pack Art.-Nr. 1005 / A2-AISI 304
Spanplattenschraube Senkkopf mit PoziDrive-Kreuzschlitz
Chipboardscrew countersunk head cross recessed

**Art.-Nr.
1005**

Standard- bestückung Standard equipment	Artikel-Nr. Item-no.	Abmessungen Dimensions	Antrieb Drive	Inhalt Blister Box Pcs. Blister Box	VE** PU**	Preis*/Blisterbox Price*/Blister Box
Nein/No	81005230 16	3,0x16	PZ1	10	10	3,20
Ja/Yes	81005230 20	3,0x20	PZ1	10	10	3,20
Nein/No	81005230 25	3,0x25	PZ1	8	10	3,20
Ja/Yes	81005230 30	3,0x30	PZ1	8	10	3,20
Nein/No	81005230 40	3,0x40	PZ1	8	10	3,20
Nein/No	81005230 50	3,0x50	PZ1	8	10	3,20
Nein/No	81005235 16	3,5x16	PZ1	10	10	3,20
Nein/No	81005235 20	3,5x20	PZ1	10	10	3,20
Nein/No	81005235 25	3,5x25	PZ1	8	10	3,20
Nein/No	81005235 30	3,5x30	PZ1	8	10	3,20
Nein/No	81005235 35	3,5x35	PZ1	8	10	3,20
Nein/No	81005240 20	4,0x20	PZ2	8	10	3,20
Nein/No	81005240 25	4,0x25	PZ2	8	10	3,20
Ja/Yes	81005240 30	4,0x30	PZ2	8	10	3,20
Nein/No	81005240 35	4,0x35	PZ2	6	10	3,20
Ja/Yes	81005240 40	4,0x40	PZ2	6	10	3,20
Nein/No	81005240 50	4,0x50	PZ2	6	10	3,20
Nein/No	81005245 30	4,5x30	PZ2	6	10	3,20
Nein/No	81005245 40	4,5x40	PZ2	6	10	3,20
Nein/No	81005245 50	4,5x50	PZ2	4	10	3,20
Nein/No	81005245 60	4,5x60	PZ2	4	10	3,20
Ja/Yes	81005250 40	5,0x40	PZ2	4	10	3,20
Ja/Yes	81005250 50	5,0x50	PZ2	4	10	3,20
Nein/No	81005250 60	5,0x60	PZ2	3	10	3,20
Nein/No	81005250 70	5,0x70	PZ2	3	10	3,20
Nein/No	81005250 80	5,0x80	PZ2	2	10	3,20
Nein/No	81005260 40	6,0x40	PZ3	2	10	3,20
Nein/No	81005260 50	6,0x50	PZ3	2	10	3,20
Ja/Yes	81005260 60	6,0x60	PZ3	2	10	3,20
Nein/No	81005260 70	6,0x70	PZ3	2	10	3,20
Nein/No	81005260 80	6,0x80	PZ3	2	10	3,20
Nein/No	81005260 100	6,0x100	PZ3	2	10	3,20

11



DIN 934

Blister Pack DIN 934 / A2-AISI 304

Sechskantmutter
Hexagon nut

Standard- bestückung Standard equipment	DIN Artikel-Nr. Item-no.	Abmessungen Dimensions	DIN Antrieb Drive	Höhe Height	Inhalt Blister Box Pcs. Blister Box	VE** PU**	Preis*/Blisterbox Price*/Blister Box
Ja/Yes	8093423	M3	SW5,5	2,4	15	10	3,20
Ja/Yes	8093424	M4	SW7	3,2	15	10	3,20
Ja/Yes	8093425	M5	SW8	4,0	15	10	3,20
Ja/Yes	8093426	M6	SW10	5,0	10	10	3,20
Ja/Yes	8093428	M8	SW13	6,5	5	10	3,20
Nein/No	80934210	M10	SW17	8,0	4	10	3,20

DIN 985

Blister Pack DIN 985 / A2-AISI 304

Sechskantmutter, Poly-Stop, niedrige Form
Self-locking hexagon nut, low type



Standard- bestückung Standard equipment	DIN Artikel-Nr. Item-no.	Abmessungen Dimensions	DIN Antrieb Drive	Höhe Height	Inhalt Blister Box Pcs. Blister Box	VE** PU**	Preis*/Blisterbox Price*/Blister Box
Ja/Yes	8098523	M3	SW5,5	4,0	6	10	3,20
Ja/Yes	8098524	M4	SW7	5,0	6	10	3,20
Ja/Yes	8098525	M5	SW8	5,0	6	10	3,20
Ja/Yes	8098526	M6	SW10	6,0	4	10	3,20
Ja/Yes	8098528	M8	SW13	8,0	4	10	3,20
Nein/No	80985210	M10	SW17	10,0	2	10	3,20

DIN 1587

Blister Pack DIN 1587 / A2-AISI 304

Hutmutter, hohe Form
Hexagon dome cap nut, high type



Standard- bestückung Standard equipment	DIN Artikel-Nr. Item-no.	Abmessungen Dimensions	DIN Antrieb Drive	Höhe Height	Inhalt Blister Box Pcs. Blister Box	VE** PU**	Preis*/Blisterbox Price*/Blister Box
Ja/Yes	8158723	M3	SW5,5	7,0	4	10	3,20
Ja/Yes	8158724	M4	SW7	8,0	4	10	3,20
Ja/Yes	8158725	M5	SW8	10,0	4	10	3,20
Ja/Yes	8158726	M6	SW10	12,0	3	10	3,20
Ja/Yes	8158728	M8	SW13	15,0	3	10	3,20
Nein/No	81587210	M10	SW17	18,0	1	10	3,20

A2/AISI-304 Schrauben in SB-Verpackungen

Screws in self-service packages
Visserie sous blister en libre service

11



Blister Pack DIN 315 / A2-AISI 304
Flügelmutter, amerikanische Form
Wing nut, american type

DIN 315

Standard- bestückung Standard equipment	DIN Artikel-Nr. Item-no.	Abmessungen Dimensions	Inhalt Blister Box Pcs. Blister Box	VE** PU**	Preis*/Blisterbox Price*/Blister Box
Ja/Yes	8031523	M3	4	10	3,20
Ja/Yes	8031524	M4	4	10	3,20
Ja/Yes	8031525	M5	4	10	3,20
Ja/Yes	8031526	M6	2	10	3,20
Ja/Yes	8031528	M8	2	10	3,20
Nein/No	80315210	M10	1	10	3,20

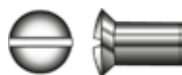

Blister Pack Art.-Nr. 1004 / A2-AISI 304
Hülsenmutter mit Linsenkopf und Schlitz
Raised countersunk head sleeve nut with slot

**Art.-Nr.
1004**

Standard- bestückung Standard equipment	Artikel-Nr. Item-no.	Abmessungen Dimensions	L	Inhalt Blister Box Pcs. Blister Box	VE** PU**	Preis*/Blisterbox Price*/Blister Box
Ja/Yes	8100424	M4	12,0	4	10	3,20
Ja/Yes	8100425	M5	15,0	4	10	3,20
Ja/Yes	8100426	M6	15,0	3	10	3,20
Ja/Yes	8100428	M8	20,0	2	10	3,20

11

DIN 125

Blister Pack DIN 125 / A2-AISI 304

Unterlegscheibe, klein
Washer, small



Standard- bestückung Standard equipment	DIN Artikel-Nr. Item-no.	iD	D	S	Inhalt Blister Box Pcs. Blister Box	VE** PU**	Preis*/Blisterbox Price*/Blister Box
Ja/Yes	80125232	3,2	7	0,5	20	10	3,20
Ja/Yes	80125243	4,3	9	0,8	20	10	3,20
Ja/Yes	80125253	5,3	10	1,0	20	10	3,20
Ja/Yes	80125264	6,4	12	1,6	20	10	3,20
Ja/Yes	80125284	8,4	16	1,6	20	10	3,20
Nein/No	801252105	10,5	20	2,0	10	10	3,20

DIN 127

Blister Pack DIN 127 / A2-AISI 301

Federring, Form B
Spring lock washer, type B



Standard- bestückung Standard equipment	DIN Artikel-Nr. Item-no.	iD	D	S	Inhalt Blister Box Pcs. Blister Box	VE** PU**	Preis*/Blisterbox Price*/Blister Box
Ja/Yes	80127232	3,2	6,2	0,8	20	10	3,20
Ja/Yes	80127243	4,3	7,6	0,9	20	10	3,20
Ja/Yes	80127253	5,3	9,2	1,2	20	10	3,20
Ja/Yes	80127264	6,4	11,8	1,6	20	10	3,20
Ja/Yes	80127284	8,4	14,8	2,0	20	10	3,20
Nein/No	801272105	10,5	18,1	2,2	10	10	3,20

Art.-Nr.
1011

Blister Pack Art.-Nr. 1011 / A1-AISI 303

Rosette, aus Vollmaterial gedreht
Rosette turned full body



Standard- bestückung Standard equipment	Artikel-Nr. Item-no.	iD	H	D	Inhalt Blister Box Pcs. Blister Box	VE** PU**	Preis*/Blisterbox Price*/Blister Box
Ja/Yes	8101123	M3	2,0	9	5	10	3,20
Ja/Yes	8101124	M4	2,5	11	4	10	3,20
Ja/Yes	8101125	M5	3,0	14	4	10	3,20
Ja/Yes	8101126	M6	3,5	16	3	10	3,20
Ja/Yes	8101128	M8	4,5	22	2	10	3,20

A2/AISI-304 Schrauben in SB-Verpackungen

Screws in self-service packages
Visserie sous blister en libre service

11



Blister Pack DIN 9021 / A2-AISI 304
Unterlegscheibe, groß
Washer, large

DIN 9021

Standard- bestückung Standard equipment	DIN Artikel-Nr. Item-no.	iD	D	S	Inhalt Blister Box Pcs. Blister Box	VE** PU**	Preis*/Blisterbox Price*/Blister Box
Ja/Yes	89021232	3,2	9	0,8	20	10	3,20
Ja/Yes	89021243	4,3	12	1,0	20	10	3,20
Ja/Yes	89021253	5,3	15	1,2	20	10	3,20
Ja/Yes	89021264	6,4	18	1,8	20	10	3,20
Ja/Yes	89021284	8,4	24	2,0	10	10	3,20
Nein/No	890212105	10,5	30	2,5	4	10	3,20



Blister Pack DIN 6799 / C3-1.4122
Sicherungsscheiben für Wellen
Retaining washer for shaft

DIN 6799

Standard- bestückung Standard equipment	DIN Artikel-Nr. Item-no.	iD	D	S	Inhalt Blister Box Pcs. Blister Box	VE** PU**	Preis*/Blisterbox Price*/Blister Box
Nein/No	86799232	3,2	7,3	0,6	20	10	3,20
Nein/No	8679924	4,0	9,3	0,7	20	10	3,20
Nein/No	8679925	5,0	11,3	0,7	20	10	3,20
Nein/No	8679926	6,0	12,3	0,7	20	10	3,20
Nein/No	8679928	8,0	16,3	1,0	15	10	3,20
Nein/No	86799210	10,0	20,4	1,2	10	10	3,20

11

DIN 3017

Blister Pack DIN 3017 / A2-AISI 304

Schlauschelle mit Schneckenantrieb
Hose Clamp



Standard- bestückung Standard equipment	DIN Artikel-Nr. Item-no.	Für Schlauch-Ø For hose-Ø	B	Inhalt Blister Box Pcs. Blister Box	VE** PU**	Preis*/Blisterbox Price*/Blister Box
Nein/No	83017210 16/9	10-16	9	2	10	3,20
Nein/No	83017212 22/12	12-22	12	2	10	3,20
Nein/No	83017212 22/9	12-22	9	2	10	3,20
Nein/No	83017216 27/12	16-27	12	2	10	3,20
Nein/No	83017216 27/9	16-27	9	2	10	3,20
Nein/No	83017220 32/12	20-32	12	2	10	3,20
Nein/No	83017220 32/9	20-32	9	2	10	3,20
Nein/No	83017225 40/12	25-40	12	2	10	3,20
Nein/No	83017225 40/9	25-40	9	2	10	3,20
Nein/No	83017230 45/12	30-45	12	2	10	3,20
Nein/No	83017230 45/9	30-45	9	2	10	3,20
Nein/No	83017235 50/12	35-50	12	1	10	3,20
Nein/No	83017235 50/9	35-50	9	1	10	3,20
Nein/No	83017240 60/12	40-60	12	1	10	3,20
Nein/No	83017240 60/9	40-60	9	1	10	3,20
Nein/No	83017250 70/9	50-70	9	1	10	3,20
Nein/No	83017280 100/12	80-100	12	1	10	3,20

A2/AISI-304 Schrauben in SB-Verpackungen

Screws in self-service packages
Visserie sous blister en libre service

11



Blister Pack DIN 94 / A2-AISI 304
Splint
Split pin

DIN 94

Standard- bestückung Standard equipment	DIN Artikel-Nr. Item-no.	Abmessungen Dimensions	Inhalt Blister Box Pcs. Blister Box	VE** PU**	Preis*/Blisterbox Price*/Blister Box
Ja/Yes	80094220 20	2,0x20	12	10	3,20
Ja/Yes	80094225 20	2,5x20	10	10	3,20
Ja/Yes	80094232 25	3,2x25	8	10	3,20
Ja/Yes	80094232 40	3,2x40	6	10	3,20
Ja/Yes	80094240 50	4,0x50	4	10	3,20
Nein/No	80094250 50	5,0x50	5	10	3,20



Blister Pack Art.-Nr. 1014 / A2-AISI 304
Blindniete, Flachkopf
Blind rivet, flat head

**Art.-Nr.
1014**

Standard- bestückung Standard equipment	Artikel-Nr. Item-no.	Abmessungen Dimensions	Klemmbereich Clamping area	Inhalt Blister Box Pcs. Blister Box	VE** PU**	Preis*/Blisterbox Price*/Blister Box
Ja/Yes	8101423 12	3,0x12	6,5-8,5	5	10	3,20
Ja/Yes	8101424 16	4,0x16	10,0-12,0	4	10	3,20
Ja/Yes	8101424 18	4,0x18	12,0-14,0	4	10	3,20
Nein/No	8101424 20	4,0x20	14,0-16,0	4	10	3,20
Nein/No	81014248 10	4,8x10	4,0-6,0	4	10	3,20
Nein/No	81014248 12	4,8x12	6,0-8,0	4	10	3,20
Nein/No	81014248 16	4,8x16	8,0-11,0	4	10	3,20
Ja/Yes	8101425 20	5,0x20	13,0-16,0	2	10	3,20
Ja/Yes	8101425 25	5,0x25	16,0-19,0	2	10	3,20
Nein/No	8101425 30	5,0x30	20,0-25,0	2	10	3,20
Nein/No	8101425 35	5,0x35	25,0-30,0	2	10	3,20
Nein/No	8101425 40	5,0x40	30,0-34,0	2	10	3,20
Nein/No	81014264 14	6,4x14	6,0-8,0	1	10	3,20
Ja/Yes	81014264 20	6,4x20	13,0-16,0	1	10	3,20
Ja/Yes	81014264 25	6,4x25	15,0-19,0	1	10	3,20

11



A4 Schrauben-Verkaufsstander bestückt

- Exklusiver, drehbarer Verkaufsstander. Grundfläche: 1 m², Höhe: 2,20m
- 261 verschiedene, gängige Schraubenabmessungen auf engstem Raum
- Keine unterschiedlichen Preisgruppen im EK- und VK-Preis
- Jede Verpackung mit Sichtfenster und Produktabbildung, EAN-Code

Display for screws A4 completely equipped

- Exclusive rotating display with a base area of only 1 m² and a height of 2.20m
- 261 different and common screw dimensions displayed
- No different cost price and sales categories
- Each package with window and product illustration, EAN-code

Affichage pour vis A4 complètement équipé

- Stand de vente exclusif et rotatif d'une surface de 1 m² seulement et d'une hauteur de 2,20m
- 261 dimensions de vis différentes et communes dans un espace très réduit
- Pas de groupes de prix différents dans les prix de la CE et du Royaume-Uni
- Chaque paquet avec fenêtre de visualisation et illustration du produit, Code EAN



Einfache Nachbestellung im 10er-Karton. Preis auf Anfrage.

Simple repeat order in cartons of 10. Price on demand.

Commande facile en boîte de 10. Prix sur demande.

900004SB

Bestückungsvarianten
Variants of equipment
Variantes d'équipement

Seite	Schrauben/Screws/Vis	Seite	Schrauben/Screws/Vis	Seite	Scheiben/Washers/Rondelles
469	DIN 84	486	DIN 95	492	DIN 125
470	DIN 963	487	DIN 97	492	DIN 127
471	DIN 964	488	DIN 97	493	Art.-Nr. 1011
472	DIN 965 ISO 14581	488	DIN 571	493	DIN 6798
473	DIN 966 ISO 14584	488	Art.-Nr. 1001	493	DIN 9021
474	DIN 7985 ISO 14583	489	Art.-Nr. 1005	Sonstiges/Others/Autre	
474	DIN 933	489	Art.-Nr. 1008	494	Art.-Nr. 8383
476	DIN 912	Muttern/Nuts/Écrous		494	DIN 94
477	DIN 6912	490	DIN 934	495	DIN 7337
477	ISO 7380-1	490	DIN 982	496	ISO 4027
478	ISO 10642	490	DIN 985	496	ISO 4029
479	DIN 603	491	DIN 1587		
480	DIN 7981 ISO 14585	491	DIN 6926		
482	DIN 7982 ISO 14586	491	DIN 315		
484	DIN 7983 ISO 14587	492	Art.-Nr. 1004		

A4/AISI-316 Schrauben in SB-Verpackungen

Screws in self-service packages
Visserie sous blister en libre service

11



Blister Pack DIN 84 + DIN 934 / A4-AISI 316
Zylinderschraube mit Schlitz und Mutter
Slotted cheese head screw with nut

DIN 84

Standard- bestückung Standard equipment	DIN Artikel-Nr. Item-no.	Abmessungen Dimensions	Inhalt Blister Box Pcs. Blister Box	VE** PU**	Preis*/Blisterbox Price*/Blister Box
Ja/Yes	9008443 10	M3x10	10	10	4,00
Ja/Yes	9008443 16	M3x16	10	10	4,00
Ja/Yes	9008443 20	M3x20	8	10	4,00
Ja/Yes	9008444 16	M4x16	8	10	4,00
Ja/Yes	9008444 20	M4x20	8	10	4,00
Ja/Yes	9008444 30	M4x30	6	10	4,00
Ja/Yes	9008444 40	M4x40	6	10	4,00
Nein/No	9008444 50	M4x50	4	10	4,00
Nein/No	9008444 60	M4x60	4	10	4,00
Nein/No	9008444 70	M4x70	4	10	4,00
Ja/Yes	9008445 20	M5x20	6	10	4,00
Ja/Yes	9008445 30	M5x30	6	10	4,00
Ja/Yes	9008445 40	M5x40	4	10	4,00
Ja/Yes	9008445 50	M5x50	4	10	4,00
Nein/No	9008445 60	M5x60	4	10	4,00
Nein/No	9008445 70	M5x70	4	10	4,00
Ja/Yes	9008446 20	M6x20	4	10	4,00
Ja/Yes	9008446 30	M6x30	4	10	4,00
Ja/Yes	9008446 40	M6x40	4	10	4,00
Nein/No	9008446 50	M6x50	4	10	4,00
Ja/Yes	9008446 60	M6x60	4	10	4,00
Nein/No	9008446 70	M6x70	4	10	4,00
Nein/No	9008446 80	M6x80	2	10	4,00
Nein/No	9008448 20	M8x20	4	10	4,00
Nein/No	9008448 30	M8x30	4	10	4,00
Nein/No	9008448 40	M8x40	4	10	4,00
Nein/No	9008448 50	M8x50	2	10	4,00
Ja/Yes	9008448 60	M8x60	2	10	4,00
Nein/No	9008448 70	M8x70	2	10	4,00
Ja/Yes	9008448 80	M8x80	2	10	4,00
Ja/Yes	9008448 100	M8x100	2	10	4,00
Nein/No	90084410 20	M10x20	2	10	4,00
Nein/No	90084410 25	M10x25	2	10	4,00
Nein/No	90084410 30	M10x30	2	10	4,00
Nein/No	90084410 50	M10x50	2	10	4,00

11

DIN 963

Blister Pack DIN 963 + DIN 934 / A4-AISI 316

Senkschraube mit Schlitz und Mutter
Slotted countersunk head screw with nut



Standard- bestückung Standard equipment	DIN Artikel-Nr. Item-no.	Abmessungen Dimensions	Inhalt Blister Box Pcs. Blister Box	VE** PU**	Preis*/Blisterbox Price*/Blister Box
Ja/Yes	9096343 10	M3x10	10	10	4,00
Ja/Yes	9096343 16	M3x16	10	10	4,00
Ja/Yes	9096343 20	M3x20	8	10	4,00
Ja/Yes	9096344 16	M4x16	8	10	4,00
Ja/Yes	9096344 20	M4x20	8	10	4,00
Ja/Yes	9096344 30	M4x30	6	10	4,00
Ja/Yes	9096344 40	M4x40	6	10	4,00
Nein/No	9096344 50	M4x50	4	10	4,00
Nein/No	9096344 60	M4x60	4	10	4,00
Ja/Yes	9096345 16	M5x16	6	10	4,00
Ja/Yes	9096345 20	M5x20	6	10	4,00
Ja/Yes	9096345 30	M5x30	6	10	4,00
Ja/Yes	9096345 40	M5x40	6	10	4,00
Ja/Yes	9096345 50	M5x50	4	10	4,00
Nein/No	9096345 60	M5x60	4	10	4,00
Nein/No	9096345 80	M5x80	4	10	4,00
Ja/Yes	9096346 20	M6x20	4	10	4,00
Ja/Yes	9096346 30	M6x30	4	10	4,00
Ja/Yes	9096346 40	M6x40	4	10	4,00
Ja/Yes	9096346 50	M6x50	4	10	4,00
Ja/Yes	9096346 60	M6x60	4	10	4,00
Nein/No	9096346 80	M6x80	2	10	4,00
Nein/No	9096346 90	M6x90	2	10	4,00
Nein/No	9096348 20	M8x20	4	10	4,00
Nein/No	9096348 30	M8x30	4	10	4,00
Nein/No	9096348 40	M8x40	4	10	4,00
Nein/No	9096348 50	M8x50	2	10	4,00
Ja/Yes	9096348 60	M8x60	2	10	4,00
Ja/Yes	9096348 80	M8x80	2	10	4,00
Ja/Yes	9096348 100	M8x100	2	10	4,00
Nein/No	90963410 25	M10x25	2	10	4,00
Nein/No	90963410 30	M10x30	2	10	4,00
Nein/No	90963410 40	M10x40	2	10	4,00
Nein/No	90963410 50	M10x50	2	10	4,00
Nein/No	90963410 60	M10x60	2	10	4,00
Nein/No	90963410 70	M10x70	2	10	4,00
Nein/No	90963410 80	M10x80	2	10	4,00
Nein/No	90963410 100	M10x100	2	10	4,00

A4/AISI-316 Schrauben in SB-Verpackungen

Screws in self-service packages
Visserie sous blister en libre service

11



Blister Pack DIN 964 + DIN 934 / A4-AISI 316
LinsensenkSchraube mit Schlitz und Mutter
Slotted raised countersunk head screw with nut

DIN 964

Standard- bestückung Standard equipment	DIN Artikel-Nr. Item-no.	Abmessungen Dimensions	Inhalt Blister Box Pcs. Blister Box	VE** PU**	Preis*/Blisterbox Price*/Blister Box
Ja/Yes	9096443 10	M3x10	10	10	4,00
Ja/Yes	9096443 16	M3x16	10	10	4,00
Ja/Yes	9096443 20	M3x20	8	10	4,00
Ja/Yes	9096444 16	M4x16	8	10	4,00
Ja/Yes	9096444 20	M4x20	8	10	4,00
Ja/Yes	9096444 30	M4x30	6	10	4,00
Ja/Yes	9096444 40	M4x40	6	10	4,00
Nein/No	9096444 50	M4x50	4	10	4,00
Nein/No	9096444 60	M4x60	4	10	4,00
Ja/Yes	9096445 16	M5x16	6	10	4,00
Ja/Yes	9096445 20	M5x20	4	10	4,00
Ja/Yes	9096445 30	M5x30	4	10	4,00
Ja/Yes	9096445 40	M5x40	4	10	4,00
Ja/Yes	9096445 50	M5x50	4	10	4,00
Nein/No	9096445 60	M5x60	4	10	4,00
Nein/No	9096445 70	M5x70	4	10	4,00
Ja/Yes	9096446 20	M6x20	4	10	4,00
Ja/Yes	9096446 30	M6x30	4	10	4,00
Ja/Yes	9096446 40	M6x40	4	10	4,00
Ja/Yes	9096446 50	M6x50	4	10	4,00
Ja/Yes	9096446 60	M6x60	4	10	4,00
Nein/No	9096446 70	M6x70	4	10	4,00
Nein/No	9096446 80	M6x80	2	10	4,00
Nein/No	9096448 20	M8x20	4	10	4,00
Nein/No	9096448 30	M8x30	4	10	4,00
Nein/No	9096448 40	M8x40	4	10	4,00
Nein/No	9096448 50	M8x50	2	10	4,00
Ja/Yes	9096448 60	M8x60	2	10	4,00
Nein/No	9096448 70	M8x70	2	10	4,00
Ja/Yes	9096448 80	M8x80	2	10	4,00
Ja/Yes	9096448 100	M8x100	2	10	4,00

11

DIN 965
ISO 14581
Blister Pack DIN 965 + DIN 934 / A4-AISI 316

 Senkschraube mit Mutter
 Countersunk head screw with nut

DIN 965



ISO 14581



Standard- bestückung Standard equipment	DIN Artikel-Nr. Item-no.	ISO Artikel-Nr. Order no	Abmessungen Dimensions	DIN Antrieb Drive	ISO Antrieb Drive	Inhalt Blister Box Pcs. Blister Box	VE** PU**	Preis*/Blisterbox Price*/Blister Box
Nein/No	9096543 10	91458143 10	M3x10	PH1	TX10	10	10	4,00
Nein/No	9096543 16	91458143 16	M3x16	PH1	TX10	10	10	4,00
Nein/No	9096543 20	91458143 20	M3x20	PH1	TX10	8	10	4,00
Nein/No	9096544 12	91458144 12	M4x12	PH2	TX20	8	10	4,00
Nein/No	9096544 16	91458144 16	M4x16	PH2	TX20	8	10	4,00
Nein/No	9096544 20	91458144 20	M4x20	PH2	TX20	8	10	4,00
Nein/No	9096544 25	91458144 25	M4x25	PH2	TX20	6	10	4,00
Nein/No	9096544 30	91458144 30	M4x30	PH2	TX20	6	10	4,00
Nein/No	9096544 40	91458144 40	M4x40	PH2	TX20	6	10	4,00
Nein/No	9096544 50	91458144 50	M4x50	PH2	TX20	4	10	4,00
Nein/No	9096544 60	91458144 60	M4x60	PH2	TX20	4	10	4,00
Nein/No	9096544 70	91458144 70	M4x70	PH2	TX20	4	10	4,00
Nein/No	9096545 12	91458145 12	M5x12	PH2	TX25	6	10	4,00
Nein/No	9096545 16	91458145 16	M5x16	PH2	TX25	6	10	4,00
Nein/No	9096545 20	91458145 20	M5x20	PH2	TX25	6	10	4,00
Nein/No	9096545 25	91458145 25	M5x25	PH2	TX25	6	10	4,00
Nein/No	9096545 30	91458145 30	M5x30	PH2	TX25	6	10	4,00
Nein/No	9096545 40	91458145 40	M5x40	PH2	TX25	6	10	4,00
Nein/No	9096545 50	91458145 50	M5x50	PH2	TX25	4	10	4,00
Nein/No	9096545 60	91458145 60	M5x60	PH2	TX25	4	10	4,00
Nein/No	9096545 70	91458145 70	M5x70	PH2	TX25	4	10	4,00
Nein/No	9096546 16	91458146 16	M6x16	PH3	TX30	4	10	4,00
Nein/No	9096546 20	91458146 20	M6x20	PH3	TX30	4	10	4,00
Nein/No	9096546 25	91458146 25	M6x25	PH3	TX30	4	10	4,00
Nein/No	9096546 30	91458146 30	M6x30	PH3	TX30	4	10	4,00
Nein/No	9096546 40	91458146 40	M6x40	PH3	TX30	4	10	4,00
Nein/No	9096546 50	91458146 50	M6x50	PH3	TX30	4	10	4,00
Nein/No	9096546 60	91458146 60	M6x60	PH3	TX30	4	10	4,00
Nein/No	9096546 70	91458146 70	M6x70	PH3	TX30	4	10	4,00
Nein/No	9096546 80	91458146 80	M6x80	PH3	TX30	2	10	4,00
Nein/No	9096546 90	91458146 90	M6x90	PH3	TX30	2	10	4,00
Nein/No	9096548 20	91458148 20	M8x20	PH4	TX45	4	10	4,00
Nein/No	9096548 25	91458148 25	M8x25	PH4	TX45	4	10	4,00
Nein/No	9096548 30	91458148 30	M8x30	PH4	TX45	4	10	4,00
Nein/No	9096548 40	91458148 40	M8x40	PH4	TX45	4	10	4,00
Nein/No	9096548 45	91458148 45	M8x45	PH4	TX45	2	10	4,00
Nein/No	9096548 50	91458148 50	M8x50	PH4	TX45	2	10	4,00
Nein/No	9096548 60	91458148 60	M8x60	PH4	TX45	2	10	4,00
Nein/No	9096548 70	91458148 70	M8x70	PH4	TX45	2	10	4,00
Nein/No	9096548 80	91458148 80	M8x80	PH4	TX45	2	10	4,00
Nein/No	90965410 50	914581410 50	M10x50	PH4	TX50	2	10	4,00
Nein/No	90965410 70	914581410 70	M10x70	PH4	TX50	2	10	4,00

A4/AISI-316 Schrauben in SB-Verpackungen

Screws in self-service packages
Visserie sous blister en libre service

11

DIN 966



ISO 14584



Blister Pack DIN 966 + DIN 934 / A4-AISI 316

Linsensenkschraube mit Mutter
Raised countersunk head screw with nut

DIN 966
ISO 14584

Standard- bestückung Standard equipment	DIN Artikel-Nr. Item-no.	ISO Artikel-Nr. Item-no.	Abmessungen Dimensions	DIN Antrieb Drive	ISO Antrieb Drive	Inhalt Blister Box Pcs. Blister Box	VE** PU**	Preis*/Blisterbox Price*/Blister Box
Nein/No	9096643 10	–	M3x10	PH1	–	10	10	4,00
Nein/No	9096643 16	–	M3x16	PH1	–	10	10	4,00
Nein/No	9096644 12	91458444 12	M4x12	PH2	TX20	6	10	4,00
Nein/No	9096644 16	91458444 16	M4x16	PH2	TX20	6	10	4,00
Nein/No	9096644 20	91458444 20	M4x20	PH2	TX20	6	10	4,00
Nein/No	9096644 25	91458444 25	M4x25	PH2	TX20	6	10	4,00
Nein/No	9096644 30	91458444 30	M4x30	PH2	TX20	6	10	4,00
Nein/No	9096644 40	91458444 40	M4x40	PH2	TX20	6	10	4,00
Nein/No	9096644 50	91458444 50	M4x50	PH2	TX20	6	10	4,00
Nein/No	9096644 70	–	M4x70	PH2	–	4	10	4,00
Nein/No	9096645 12	91458445 12	M5x12	PH2	TX25	8	10	4,00
Nein/No	9096645 16	91458445 16	M5x16	PH2	TX25	6	10	4,00
Nein/No	9096645 20	91458445 20	M5x20	PH2	TX25	6	10	4,00
Nein/No	9096645 25	91458445 25	M5x25	PH2	TX25	6	10	4,00
Nein/No	9096645 30	91458445 30	M5x30	PH2	TX25	6	10	4,00
Nein/No	9096645 40	91458445 40	M5x40	PH2	TX25	4	10	4,00
Nein/No	9096645 50	91458445 50	M5x50	PH2	TX25	4	10	4,00
Nein/No	9096645 60	91458445 60	M5x60	PH2	TX25	4	10	4,00
Nein/No	9096645 70	–	M5x70	PH2	–	4	10	4,00
Nein/No	9096646 16	91458446 16	M6x16	PH3	TX30	4	10	4,00
Nein/No	9096646 20	91458446 20	M6x20	PH3	TX30	4	10	4,00
Nein/No	9096646 25	91458446 25	M6x25	PH3	TX30	4	10	4,00
Nein/No	9096646 30	91458446 30	M6x30	PH3	TX30	4	10	4,00
Nein/No	9096646 35	91458446 35	M6x35	PH3	TX30	4	10	4,00
Nein/No	9096646 40	91458446 40	M6x40	PH3	TX30	4	10	4,00
Nein/No	9096646 50	91458446 50	M6x50	PH3	TX30	4	10	4,00
Nein/No	9096646 60	91458446 60	M6x60	PH3	TX30	4	10	4,00
Nein/No	9096648 60	–	M8x60	PH4	–	2	10	4,00

11

DIN 7985 ISO 14583

Blister Pack DIN 7985 + DIN 934 / A4-AISI 316
Linsenschraube mit Mutter
Raised cheese head screw with nut

DIN 7985



ISO 14583

Standard- bestückung Standard equipment	DIN Artikel-Nr. Item-no.	ISO Artikel-Nr. Order no	Abmessungen Dimensions	DIN Antrieb Drive	ISO Antrieb Drive	Inhalt Blister Box Pcs. Blister Box	VE** PU**	Preis*/Blisterbox Price*/Blister Box
Nein/No	9798543 10	91458343 10	M3x10	PH1	TX10	10	10	4,00
Nein/No	9798543 16	91458343 16	M3x16	PH1	TX10	10	10	4,00
Nein/No	9798543 20	91458343 20	M3x20	PH1	TX10	8	10	4,00
Nein/No	9798544 16	91458344 16	M4x16	PH2	TX20	8	10	4,00
Nein/No	9798544 20	91458344 20	M4x20	PH2	TX20	8	10	4,00
Nein/No	9798544 25	91458344 25	M4x25	PH2	TX20	6	10	4,00
Nein/No	9798544 30	91458344 30	M4x30	PH2	TX20	6	10	4,00
Nein/No	9798544 40	91458344 40	M4x40	PH2	TX20	6	10	4,00
Nein/No	9798544 50	91458344 50	M4x50	PH2	TX20	6	10	4,00
Nein/No	9798544 60	91458344 60	M4x60	PH2	TX20	6	10	4,00
Nein/No	9798545 20	91458345 20	M5x20	PH2	TX25	6	10	4,00
Nein/No	9798545 30	91458345 30	M5x30	PH2	TX25	6	10	4,00
Nein/No	9798545 40	91458345 40	M5x40	PH2	TX25	4	10	4,00
Nein/No	9798545 50	91458345 50	M5x50	PH2	TX25	4	10	4,00
Nein/No	9798546 20	91458346 20	M6x20	PH3	TX30	4	10	4,00
Nein/No	9798546 25	91458346 25	M6x25	PH3	TX30	4	10	4,00
Nein/No	9798546 30	91458346 30	M6x30	PH3	TX30	4	10	4,00
Nein/No	9798546 40	91458346 40	M6x40	PH3	TX30	4	10	4,00
Nein/No	9798546 50	91458346 50	M6x50	PH3	TX30	4	10	4,00
Nein/No	9798546 60	91458346 60	M6x60	PH3	TX30	4	10	4,00
Nein/No	9798548 35	91458348 35	M8x35	PH4	TX45	4	10	4,00
Nein/No	9798548 40	91458348 40	M8x40	PH4	TX45	4	10	4,00
Nein/No	9798548 60	91458348 60	M8x60	PH4	TX45	2	10	4,00
Nein/No	9798548 70	91458348 70	M8x70	PH4	TX45	2	10	4,00
Nein/No	9798548 80	91458348 80	M8x80	PH4	TX45	2	10	4,00

DIN 933

Blister Pack DIN 933 + DIN 934 / A4-AISI 316
Sechskantschraube mit Mutter
Hexagon head screw with nut



Standard- bestückung Standard equipment	DIN Artikel-Nr. Item-no.	Abmessungen Dimensions	DIN Antrieb Drive	Inhalt Blister Box Pcs. Blister Box	VE** PU**	Preis*/Blisterbox Price*/Blister Box
Nein/No	9093344 16	M4x16	SW7	8	10	4,00
Nein/No	9093344 20	M4x20	SW7	8	10	4,00
Nein/No	9093344 25	M4x25	SW7	6	10	4,00
Nein/No	9093344 30	M4x30	SW7	6	10	4,00
Nein/No	9093344 40	M4x40	SW7	6	10	4,00
Nein/No	9093344 50	M4x50	SW7	4	10	4,00
Nein/No	9093344 60	M4x60	SW7	4	10	4,00
Nein/No	9093345 10	M5x10	SW8	8	10	4,00
Ja/Yes	9093345 16	M5x16	SW8	8	10	4,00
Ja/Yes	9093345 20	M5x20	SW8	8	10	4,00
Ja/Yes	9093345 25	M5x25	SW8	6	10	4,00
Ja/Yes	9093345 30	M5x30	SW8	6	10	4,00
Ja/Yes	9093345 40	M5x40	SW8	6	10	4,00

A4/AISI-316 Schrauben in SB-Verpackungen

Screws in self-service packages
Visserie sous blister en libre service

11



Blister Pack DIN 933 + DIN 934 / A4-AISI 316

Sechskantschraube mit Mutter
Hexagon head screw with nut

DIN 933

Standard- bestückung Standard equipment	DIN Artikel-Nr. Item-no.	Abmessungen Dimensions	DIN Antrieb Drive	Inhalt Blister Box Pcs. Blister Box	VE** PU**	Preis*/Blisterbox Price*/Blister Box
Ja/Yes	9093345 50	M5x50	SW8	4	10	4,00
Nein/No	9093345 60	M5x60	SW8	4	10	4,00
Nein/No	9093345 70	M5x70	SW8	4	10	4,00
Nein/No	9093345 80	M5x80	SW8	4	10	4,00
Ja/Yes	9093346 20	M6x20	SW10	6	10	4,00
Ja/Yes	9093346 25	M6x25	SW10	6	10	4,00
Ja/Yes	9093346 30	M6x30	SW10	4	10	4,00
Ja/Yes	9093346 40	M6x40	SW10	4	10	4,00
Nein/No	9093346 50	M6x50	SW10	4	10	4,00
Ja/Yes	9093346 60	M6x60	SW10	4	10	4,00
Nein/No	9093346 70	M6x70	SW10	2	10	4,00
Nein/No	9093346 80	M6x80	SW10	2	10	4,00
Nein/No	9093346 100	M6x100	SW10	2	10	4,00
Nein/No	9093348 20	M8x20	SW13	4	10	4,00
Nein/No	9093348 25	M8x25	SW13	4	10	4,00
Ja/Yes	9093348 30	M8x30	SW13	4	10	4,00
Ja/Yes	9093348 40	M8x40	SW13	4	10	4,00
Ja/Yes	9093348 50	M8x50	SW13	2	10	4,00
Ja/Yes	9093348 60	M8x60	SW13	2	10	4,00
Nein/No	9093348 70	M8x70	SW13	2	10	4,00
Ja/Yes	9093348 80	M8x80	SW13	2	10	4,00
Ja/Yes	9093348 100	M8x100	SW13	2	10	4,00
Nein/No	90933410 20	M10x20	SW17	2	10	4,00
Nein/No	90933410 25	M10x25	SW17	2	10	4,00
Nein/No	90933410 30	M10x30	SW17	2	10	4,00
Nein/No	90933410 40	M10x40	SW17	2	10	4,00
Nein/No	90933410 50	M10x50	SW17	2	10	4,00
Nein/No	90933410 60	M10x60	SW17	2	10	4,00
Nein/No	90933410 70	M10x70	SW17	2	10	4,00
Nein/No	90933410 75	M10x75	SW17	1	10	4,00
Nein/No	90933410 80	M10x80	SW17	1	10	4,00
Nein/No	90933410 90	M10x90	SW17	1	10	4,00
Nein/No	90933410 100	M10x100	SW17	1	10	4,00
Nein/No	90933412 20	M12x20	SW19	2	10	4,00
Nein/No	90933412 25	M12x25	SW19	2	10	4,00
Nein/No	90933412 30	M12x30	SW19	2	10	4,00
Nein/No	90933412 40	M12x40	SW19	2	10	4,00
Nein/No	90933412 50	M12x50	SW19	2	10	4,00
Nein/No	90933412 60	M12x60	SW19	2	10	4,00
Nein/No	90933412 70	M12x70	SW19	2	10	4,00
Nein/No	90933412 75	M12x75	SW19	1	10	4,00
Nein/No	90933412 80	M12x80	SW19	1	10	4,00
Nein/No	90933412 90	M12x90	SW19	1	10	4,00
Nein/No	90933412 100	M12x100	SW19	1	10	4,00

DIN 912

Blister Pack DIN 912 + DIN 934 / A4-AISI 316

Zylinderschraube mit Innensechskant und Mutter
Hexagon socket head cap screw with nut



Standard- bestückung Standard equipment	DIN Artikel-Nr. Item-no.	Abmessungen Dimensions	DIN Antrieb Drive	Inhalt Blister Box Pcs. Blister Box	VE** PU**	Preis*/Blisterbox Price*/Blister Box
Nein/No	9091243 10	M3x10	SW2,5	10	10	4,00
Nein/No	9091243 12	M3x12	SW2,5	8	10	4,00
Nein/No	9091243 16	M3x16	SW2,5	8	10	4,00
Nein/No	9091243 20	M3x20	SW2,5	8	10	4,00
Nein/No	9091244 12	M4x12	SW3	8	10	4,00
Nein/No	9091244 16	M4x16	SW3	8	10	4,00
Nein/No	9091244 20	M4x20	SW3	8	10	4,00
Nein/No	9091244 25	M4x25	SW3	6	10	4,00
Nein/No	9091244 30	M4x30	SW3	6	10	4,00
Nein/No	9091244 40	M4x40	SW3	6	10	4,00
Nein/No	9091244 50	M4x50	SW3	6	10	4,00
Nein/No	9091244 60	M4x60	SW3	6	10	4,00
Nein/No	9091245 12	M5x12	SW4	6	10	4,00
Nein/No	9091245 16	M5x16	SW4	6	10	4,00
Nein/No	9091245 20	M5x20	SW4	6	10	4,00
Nein/No	9091245 25	M5x25	SW4	6	10	4,00
Nein/No	9091245 30	M5x30	SW4	6	10	4,00
Nein/No	9091245 40	M5x40	SW4	6	10	4,00
Nein/No	9091245 50	M5x50	SW4	4	10	4,00
Nein/No	9091245 60	M5x60	SW4	4	10	4,00
Nein/No	9091245 80	M5x80	SW4	4	10	4,00
Nein/No	9091246 10	M6x10	SW5	4	10	4,00
Nein/No	9091246 16	M6x16	SW5	4	10	4,00
Nein/No	9091246 20	M6x20	SW5	4	10	4,00
Nein/No	9091246 25	M6x25	SW5	4	10	4,00
Nein/No	9091246 30	M6x30	SW5	4	10	4,00
Nein/No	9091246 40	M6x40	SW5	4	10	4,00
Nein/No	9091246 50	M6x50	SW5	4	10	4,00
Nein/No	9091246 60	M6x60	SW5	4	10	4,00
Nein/No	9091246 70	M6x70	SW5	2	10	4,00
Nein/No	9091246 80	M6x80	SW5	2	10	4,00
Nein/No	9091248 20	M8x20	SW6	2	10	4,00
Nein/No	9091248 25	M8x25	SW6	2	10	4,00
Nein/No	9091248 30	M8x30	SW6	2	10	4,00
Nein/No	9091248 40	M8x40	SW6	2	10	4,00
Nein/No	9091248 50	M8x50	SW6	2	10	4,00
Nein/No	9091248 60	M8x60	SW6	2	10	4,00
Nein/No	9091248 70	M8x70	SW6	2	10	4,00
Nein/No	9091248 80	M8x80	SW6	2	10	4,00
Nein/No	9091248 100	M8x100	SW6	2	10	4,00
Nein/No	90912410 30	M10x30	SW10	2	10	4,00
Nein/No	90912410 40	M10x40	SW10	2	10	4,00
Nein/No	90912410 50	M10x50	SW10	2	10	4,00

A4/AISI-316 Schrauben in SB-Verpackungen

Screws in self-service packages
Visserie sous blister en libre service

11



Blister Pack DIN 6912 + DIN 934 / A4-AISI 316
Zylinderschraube mit Innensechskant, niedriger Kopf mit Mutter
Socket head cap screw, low head with nut

DIN 6912

Standard- bestückung Standard equipment	DIN Artikel-Nr. Item-no.	Abmessungen Dimensions	DIN Antrieb Drive	Inhalt Blister Box Pcs. Blister Box	VE** PU**	Preis*/Blisterbox Price*/Blister Box
Nein/No	9691245 20	M5x20	SW4	8	10	4,00
Nein/No	9691245 40	M5x40	SW4	6	10	4,00
Nein/No	9691246 40	M6x40	SW5	4	10	4,00
Nein/No	9691246 60	M6x60	SW5	4	10	4,00
Nein/No	9691248 40	M8x40	SW6	4	10	4,00
Nein/No	9691248 60	M8x60	SW6	2	10	4,00
Nein/No	9691248 80	M8x80	SW6	2	10	4,00

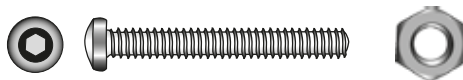

Blister Pack ISO 7380-1 + DIN 934 / A4-AISI 316
Linsenkopfschraube mit Innensechskant und Mutter
Hexagon socket button head screw with nut

NEW

ISO 7380-1

Standard- bestückung Standard equipment	DIN Artikel-Nr. Item-no.	Abmessungen Dimensions	Antrieb Drive	Inhalt Blister Box Pcs. Blister Box	VE** PU**	Preis*/Blisterbox Price*/Blister Box
Nein/No	97380144 16	M4x16	SW2,5	10	10	4,00
Nein/No	97380144 20	M4x20	SW2,5	8	10	4,00
Nein/No	97380144 30	M4x30	SW2,5	8	10	4,00
Nein/No	97380144 40	M4x40	SW2,5	6	10	4,00
Nein/No	97380144 50	M4x50	SW2,5	6	10	4,00
Nein/No	97380144 60	M4x60	SW2,5	4	10	4,00
Nein/No	97380145 10	M5x10	SW3	10	10	4,00
Nein/No	97380145 16	M5x16	SW3	10	10	4,00
Nein/No	97380145 20	M5x20	SW3	8	10	4,00
Nein/No	97380145 30	M5x30	SW3	8	10	4,00
Nein/No	97380145 40	M5x40	SW3	6	10	4,00
Nein/No	97380145 50	M5x50	SW3	6	10	4,00
Nein/No	97380145 60	M5x60	SW3	4	10	4,00
Nein/No	97380146 16	M6x16	SW4	10	10	4,00
Nein/No	97380146 20	M6x20	SW4	8	10	4,00
Nein/No	97380146 30	M6x30	SW4	8	10	4,00
Nein/No	97380146 40	M6x40	SW4	6	10	4,00
Nein/No	97380146 50	M6x50	SW4	6	10	4,00
Nein/No	97380146 60	M6x60	SW4	4	10	4,00
Nein/No	97380148 40	M8x40	SW5	4	10	4,00
Nein/No	97380148 60	M8x60	SW5	2	10	4,00
Nein/No	97380148 80	M8x80	SW5	2	10	4,00

11

ISO 10642

Blister Pack ISO 10642 + DIN 934 / A4-AISI 316

Senkschraube mit Innensechskant mit Mutter
Hexagon socket countersunk head screw with nut



Standard- bestückung Standard equipment	DIN Artikel-Nr. Item-no.	Abmessungen Dimensions	DIN Antrieb Drive	Inhalt Blister Box Pcs. Blister Box	VE** PU**	Preis*/Blisterbox Price*/Blister Box
Nein/No	91064243 20	M3x20	SW2	8	10	4,00
Nein/No	91064244 16	M4x16	SW2,5	8	10	4,00
Nein/No	91064244 20	M4x20	SW2,5	8	10	4,00
Nein/No	91064244 30	M4x30	SW2,5	6	10	4,00
Nein/No	91064244 40	M4x40	SW2,5	6	10	4,00
Nein/No	91064244 50	M4x50	SW2,5	4	10	4,00
Nein/No	91064245 16	M5x16	SW3	6	10	4,00
Nein/No	91064245 20	M5x20	SW3	6	10	4,00
Nein/No	91064245 30	M5x30	SW3	6	10	4,00
Nein/No	91064245 40	M5x40	SW3	4	10	4,00
Nein/No	91064245 50	M5x50	SW3	4	10	4,00
Nein/No	91064245 60	M5x60	SW3	4	10	4,00
Nein/No	91064246 20	M6x20	SW4	4	10	4,00
Nein/No	91064246 30	M6x30	SW4	4	10	4,00
Nein/No	91064246 40	M6x40	SW4	4	10	4,00
Nein/No	91064246 50	M6x50	SW4	4	10	4,00
Nein/No	91064246 60	M6x60	SW4	4	10	4,00
Nein/No	91064246 80	M6x80	SW4	2	10	4,00
Nein/No	91064248 20	M8x20	SW5	4	10	4,00
Nein/No	91064248 30	M8x30	SW5	4	10	4,00
Nein/No	91064248 40	M8x40	SW5	4	10	4,00
Nein/No	91064248 50	M8x50	SW5	2	10	4,00
Nein/No	91064248 60	M8x60	SW5	2	10	4,00
Nein/No	91064248 80	M8x80	SW5	2	10	4,00
Nein/No	91064248 100	M8x100	SW5	2	10	4,00
Nein/No	910642410 20	M10x20	SW6	2	10	4,00
Nein/No	910642410 40	M10x40	SW6	2	10	4,00

A4/AISI-316 Schrauben in SB-Verpackungen

Screws in self-service packages
Visserie sous blister en libre service

11



Blister Pack DIN 603 + DIN 934 / A4-AISI 316
Flachrundschaube mit Vierkantansatz und Mutter
Mushroom head square neck bolt with nut

DIN 603

Standard- bestückung Standard equipment	DIN Artikel-Nr. Item-no.	Abmessungen Dimensions	Inhalt Blister Box Pcs. Blister Box	VE** PU**	Preis*/Blisterbox Price*/Blister Box
Nein/No	9060345 16	M5x16	6	10	4,00
Nein/No	9060345 20	M5x20	4	10	4,00
Nein/No	9060345 30	M5x30	4	10	4,00
Nein/No	9060345 40	M5x40	4	10	4,00
Nein/No	9060345 50	M5x50	4	10	4,00
Nein/No	9060345 60	M5x60	4	10	4,00
Nein/No	9060345 70	M5x70	4	10	4,00
Nein/No	9060346 16	M6x16	4	10	4,00
Nein/No	9060346 20	M6x20	4	10	4,00
Ja/Yes	9060346 25	M6x25	4	10	4,00
Ja/Yes	9060346 30	M6x30	4	10	4,00
Ja/Yes	9060346 40	M6x40	4	10	4,00
Ja/Yes	9060346 50	M6x50	4	10	4,00
Ja/Yes	9060346 60	M6x60	2	10	4,00
Nein/No	9060346 80	M6x80	2	10	4,00
Nein/No	9060346 100	M6x100	1	10	4,00
Ja/Yes	9060348 40	M8x40	2	10	4,00
Ja/Yes	9060348 60	M8x60	2	10	4,00
Ja/Yes	9060348 70	M8x70	2	10	4,00
Ja/Yes	9060348 80	M8x80	2	10	4,00
Nein/No	9060348 100	M8x100	1	10	4,00
Nein/No	90603410 25	M10x25	2	10	4,00
Nein/No	90603410 30	M10x30	2	10	4,00
Nein/No	90603410 40	M10x40	2	10	4,00
Nein/No	90603410 50	M10x50	1	10	4,00
Nein/No	90603410 60	M10x60	1	10	4,00
Nein/No	90603410 80	M10x80	1	10	4,00
Nein/No	90603410 100	M10x100	1	10	4,00

11

DIN 7981
ISO 14585
Blister Pack DIN 7981 / A4-AISI 316

 Blechschraube, Linsenkopf
 Tapping screw, pan head

DIN 7981



ISO 14585



Standard- bestückung Standard equipment	DIN Artikel-Nr. Item-no.	ISO Artikel-Nr. Order no	Abmessungen Dimensions	DIN Antrieb Drive	ISO Antrieb Drive	Inhalt Blister Box Pcs. Blister Box	VE** PU**	Preis*/Blisterbox Price*/Blister Box
Ja/Yes	97981429 95	914585429 95	2,9x9,5	PH1	TX10	20	10	4,00
Ja/Yes	97981429 13	914585429 13	2,9x13	PH1	TX10	20	10	4,00
Ja/Yes	97981429 16	914585429 16	2,9x16	PH1	TX10	20	10	4,00
Nein/No	97981429 19	914585429 19	2,9x19	PH1	TX10	20	10	4,00
Nein/No	97981429 25	914585429 25	2,9x25	PH1	TX10	15	10	4,00
Nein/No	97981429 32	914585429 32	2,9x32	PH1	TX10	10	10	4,00
Nein/No	97981435 95	914585435 95	3,5x9,5	PH2	TX15	15	10	4,00
Ja/Yes	97981435 13	914585435 13	3,5x13	PH2	TX15	15	10	4,00
Ja/Yes	97981435 16	914585435 16	3,5x16	PH2	TX15	12	10	4,00
Ja/Yes	97981435 19	914585435 19	3,5x19	PH2	TX15	12	10	4,00
Nein/No	97981435 22	914585435 22	3,5x22	PH2	TX15	12	10	4,00
Ja/Yes	97981435 25	914585435 25	3,5x25	PH2	TX15	12	10	4,00
Nein/No	97981435 32	914585435 32	3,5x32	PH2	TX15	10	10	4,00
Nein/No	97981435 38	914585435 38	3,5x38	PH2	TX15	10	10	4,00
Nein/No	97981439 13	914585439 13	3,9x13	PH2	TX15	12	10	4,00
Nein/No	97981439 16	914585439 16	3,9x16	PH2	TX15	12	10	4,00
Nein/No	97981439 19	914585439 19	3,9x19	PH2	TX15	12	10	4,00
Nein/No	97981439 25	914585439 25	3,9x25	PH2	TX15	12	10	4,00
Nein/No	97981439 32	914585439 32	3,9x32	PH2	TX15	10	10	4,00
Nein/No	97981439 38	914585439 38	3,9x38	PH2	TX15	10	10	4,00
Ja/Yes	97981442 13	914585442 13	4,2x13	PH2	TX20	12	10	4,00
Ja/Yes	97981442 16	914585442 16	4,2x16	PH2	TX20	12	10	4,00
Ja/Yes	97981442 19	914585442 19	4,2x19	PH2	TX20	12	10	4,00
Nein/No	97981442 22	914585442 22	4,2x22	PH2	TX20	10	10	4,00
Ja/Yes	97981442 25	914585442 25	4,2x25	PH2	TX20	10	10	4,00
Ja/Yes	97981442 32	914585442 32	4,2x32	PH2	TX20	10	10	4,00
Nein/No	97981442 38	914585442 38	4,2x38	PH2	TX20	6	10	4,00
Nein/No	97981442 45	914585442 45	4,2x45	PH2	TX20	6	10	4,00
Nein/No	97981442 50	914585442 50	4,2x50	PH2	TX20	4	10	4,00
Nein/No	97981442 60	914585442 60	4,2x60	PH2	TX20	4	10	4,00
Ja/Yes	97981448 13	914585448 13	4,8x13	PH2	TX25	10	10	4,00
Nein/No	97981448 16	914585448 16	4,8x16	PH2	TX25	10	10	4,00
Ja/Yes	97981448 19	914585448 19	4,8x19	PH2	TX25	10	10	4,00
Nein/No	97981448 22	914585448 22	4,8x22	PH2	TX25	10	10	4,00
Ja/Yes	97981448 25	914585448 25	4,8x25	PH2	TX25	10	10	4,00
Ja/Yes	97981448 32	914585448 32	4,8x32	PH2	TX25	6	10	4,00
Nein/No	97981448 38	914585448 38	4,8x38	PH2	TX25	6	10	4,00
Nein/No	97981448 45	914585448 45	4,8x45	PH2	TX25	6	10	4,00
Nein/No	97981448 50	914585448 50	4,8x50	PH2	TX25	4	10	4,00
Nein/No	97981448 60	914585448 60	4,8x60	PH2	TX25	4	10	4,00
Nein/No	97981448 70	914585448 70	4,8x70	PH2	TX25	4	10	4,00

A4/AISI-316 Schrauben in SB-Verpackungen

Screws in self-service packages
Visserie sous blister en libre service

11

DIN 7981



ISO 14585



Blister Pack DIN 7981 / A4-AISI 316
Blechschaube, Linsenkopf
Tapping screw, pan head

DIN 7981
ISO 14585

Standard- bestückung Standard equipment	DIN Artikel-Nr. Item-no.	ISO Artikel-Nr. Item-no.	Abmessungen Dimensions	DIN Antrieb Drive	ISO Antrieb Drive	Inhalt Blister Box Pcs. Blister Box	VE** PU**	Preis*/Blisterbox Price*/Blister Box
Ja/Yes	97981455 16	914585455 16	5,5x16	PH3	TX25	6	10	4,00
Nein/No	97981455 19	914585455 19	5,5x19	PH3	TX25	6	10	4,00
Ja/Yes	97981455 25	914585455 25	5,5x25	PH3	TX25	6	10	4,00
Ja/Yes	97981455 32	914585455 32	5,5x32	PH3	TX25	6	10	4,00
Ja/Yes	97981455 38	914585455 38	5,5x38	PH3	TX25	6	10	4,00
Nein/No	97981455 45	914585455 45	5,5x45	PH3	TX25	4	10	4,00
Nein/No	97981455 50	914585455 50	5,5x50	PH3	TX25	4	10	4,00
Nein/No	97981455 60	914585455 60	5,5x60	PH3	TX25	4	10	4,00
Nein/No	97981463 19	914585463 19	6,3x19	PH3	TX30	6	10	4,00
Nein/No	97981463 25	914585463 25	6,3x25	PH3	TX30	6	10	4,00
Nein/No	97981463 32	914585463 32	6,3x32	PH3	TX30	6	10	4,00
Nein/No	97981463 38	914585463 38	6,3x38	PH3	TX30	6	10	4,00
Nein/No	97981463 50	914585463 50	6,3x50	PH3	TX30	4	10	4,00

11

DIN 7982
ISO 14586
Blister Pack DIN 7982 / A4-AISI 316

 Blechschraube, Senkkopf
 Tapping screw, countersunk head

DIN 7982



ISO 14586



Standard- bestückung Standard equipment	DIN Artikel-Nr. Item-no.	ISO Artikel-Nr. Order no	Abmessungen Dimensions	DIN Antrieb Drive	ISO Antrieb Drive	Inhalt Blister Box Pcs. Blister Box	VE** PU**	Preis*/Blisterbox Price*/Blister Box
Ja/Yes	97982429 95	914586429 95	2,9x9,5	PH1	TX10	20	10	4,00
Ja/Yes	97982429 13	914586429 13	2,9x13	PH1	TX10	20	10	4,00
Ja/Yes	97982429 16	914586429 16	2,9x16	PH1	TX10	20	10	4,00
Nein/No	97982429 19	914586429 19	2,9x19	PH1	TX10	20	10	4,00
Nein/No	97982429 25	914586429 25	2,9x25	PH1	TX10	15	10	4,00
Nein/No	97982429 32	914586429 32	2,9x32	PH1	TX10	10	10	4,00
Nein/No	97982435 95	914586435 95	3,5x9,5	PH2	TX15	15	10	4,00
Ja/Yes	97982435 13	914586435 13	3,5x13	PH2	TX15	15	10	4,00
Ja/Yes	97982435 16	914586435 16	3,5x16	PH2	TX15	12	10	4,00
Ja/Yes	97982435 19	914586435 19	3,5x19	PH2	TX15	12	10	4,00
Ja/Yes	97982435 25	914586435 25	3,5x25	PH2	TX15	12	10	4,00
Nein/No	97982435 32	914586435 32	3,5x32	PH2	TX15	10	10	4,00
Nein/No	97982435 38	914586435 38	3,5x38	PH2	TX15	10	10	4,00
Nein/No	97982439 13	914586439 13	3,9x13	PH2	TX15	12	10	4,00
Nein/No	97982439 19	914586439 19	3,9x19	PH2	TX15	12	10	4,00
Nein/No	97982439 25	914586439 25	3,9x25	PH2	TX15	12	10	4,00
Nein/No	97982439 32	914586439 32	3,9x32	PH2	TX15	10	10	4,00
Nein/No	97982439 38	914586439 38	3,9x38	PH2	TX15	10	10	4,00
Nein/No	97982442 95	914586442 95	4,2x9,5	PH2	TX20	12	10	4,00
Ja/Yes	97982442 13	914586442 13	4,2x13	PH2	TX20	12	10	4,00
Ja/Yes	97982442 16	914586442 16	4,2x16	PH2	TX20	12	10	4,00
Ja/Yes	97982442 19	914586442 19	4,2x19	PH2	TX20	12	10	4,00
Ja/Yes	97982442 25	914586442 25	4,2x25	PH2	TX20	10	10	4,00
Ja/Yes	97982442 32	914586442 32	4,2x32	PH2	TX20	10	10	4,00
Nein/No	97982442 38	914586442 38	4,2x38	PH2	TX20	6	10	4,00
Nein/No	97982442 45	914586442 45	4,2x45	PH2	TX20	6	10	4,00
Nein/No	97982442 50	914586442 50	4,2x50	PH2	TX20	4	10	4,00
Nein/No	97982442 60	914586442 60	4,2x60	PH2	TX20	4	10	4,00
Ja/Yes	97982448 13	914586448 13	4,8x13	PH2	TX25	10	10	4,00
Nein/No	97982448 16	914586448 16	4,8x16	PH2	TX25	10	10	4,00
Ja/Yes	97982448 19	914586448 19	4,8x19	PH2	TX25	10	10	4,00
Ja/Yes	97982448 25	914586448 25	4,8x25	PH2	TX25	10	10	4,00
Ja/Yes	97982448 32	914586448 32	4,8x32	PH2	TX25	6	10	4,00
Nein/No	97982448 38	914586448 38	4,8x38	PH2	TX25	6	10	4,00
Nein/No	97982448 45	914586448 45	4,8x45	PH2	TX25	6	10	4,00
Nein/No	97982448 50	914586448 50	4,8x50	PH2	TX25	4	10	4,00
Nein/No	97982448 60	914586448 60	4,8x60	PH2	TX25	4	10	4,00
Nein/No	97982448 70	914586448 70	4,8x70	PH2	TX25	4	10	4,00
Ja/Yes	97982455 16	914586455 16	5,5x16	PH3	TX25	6	10	4,00
Nein/No	97982455 19	914586455 19	5,5x19	PH3	TX25	6	10	4,00
Ja/Yes	97982455 25	914586455 25	5,5x25	PH3	TX25	6	10	4,00
Ja/Yes	97982455 32	914586455 32	5,5x32	PH3	TX25	6	10	4,00

A4/AISI-316 Schrauben in SB-Verpackungen

Screws in self-service packages
Visserie sous blister en libre service

11

DIN 7982



ISO 14586



Blister Pack DIN 7982 / A4-AISI 316

Blechschraube, Senkkopf

Tapping screw, countersunk head

DIN 7982
ISO 14586

Standard- bestückung Standard equipment	DIN Artikel-Nr. Item-no.	ISO Artikel-Nr. Item-no.	Abmessungen Dimensions	DIN Antrieb Drive	ISO Antrieb Drive	Inhalt Blister Box Pcs. Blister Box	VE** PU**	Preis*/Blisterbox Price*/Blister Box
Ja/Yes	97982455 38	914586455 38	5,5x38	PH3	TX25	6	10	4,00
Nein/No	97982455 45	914586455 45	5,5x45	PH3	TX25	6	10	4,00
Nein/No	97982455 50	914586455 50	5,5x50	PH3	TX25	4	10	4,00
Nein/No	97982455 60	914586455 60	5,5x60	PH3	TX25	4	10	4,00
Nein/No	97982463 25	914586463 25	6,3x25	PH3	TX30	6	10	4,00
Nein/No	97982463 32	914586463 32	6,3x32	PH3	TX30	6	10	4,00
Nein/No	97982463 38	914586463 38	6,3x38	PH3	TX30	6	10	4,00
Nein/No	97982463 50	914586463 50	6,3x50	PH3	TX30	6	10	4,00
Nein/No	97982463 60	914586463 60	6,3x60	PH3	TX30	4	10	4,00

11

DIN 7983
ISO 14587
Blister Pack DIN 7983 / A4-AISI 316
 Blechschraube, Linsensenkkopf
 Tapping screw, raised countersunk head

DIN 7983



ISO 14587



Standard- bestückung Standard equipment	DIN Artikel-Nr. Item-no.	ISO Artikel-Nr. Order no	Abmessungen Dimensions	DIN Antrieb Drive	ISO Antrieb Drive	Inhalt Blister Box Pcs. Blister Box	VE** PU**	Preis*/Blisterbox Price*/Blister Box
Ja/Yes	97983429 95	914587429 95	2,9x9,5	PH1	TX10	20	10	4,00
Ja/Yes	97983429 13	914587429 13	2,9x13	PH1	TX10	20	10	4,00
Ja/Yes	97983429 16	914587429 16	2,9x16	PH1	TX10	20	10	4,00
Nein/No	97983429 19	914587429 19	2,9x19	PH1	TX10	15	10	4,00
Nein/No	97983429 22	914587429 22	2,9x22	PH1	TX10	15	10	4,00
Nein/No	97983429 25	914587429 25	2,9x25	PH1	TX10	12	10	4,00
Nein/No	97983435 95	914587435 95	3,5x9,5	PH2	TX15	15	10	4,00
Ja/Yes	97983435 13	914587435 13	3,5x13	PH2	TX15	15	10	4,00
Ja/Yes	97983435 16	914587435 16	3,5x16	PH2	TX15	12	10	4,00
Ja/Yes	97983435 19	914587435 19	3,5x19	PH2	TX15	12	10	4,00
Ja/Yes	97983435 25	914587435 25	3,5x25	PH2	TX15	12	10	4,00
Nein/No	97983435 32	914587435 32	3,5x32	PH2	TX15	10	10	4,00
Nein/No	97983435 38	914587435 38	3,5x38	PH2	TX15	10	10	4,00
Nein/No	97983439 13	914587439 13	3,9x13	PH2	TX15	12	10	4,00
Nein/No	97983439 16	914587439 16	3,9x16	PH2	TX15	12	10	4,00
Nein/No	97983439 19	914587439 19	3,9x19	PH2	TX15	12	10	4,00
Nein/No	97983439 25	914587439 25	3,9x25	PH2	TX15	12	10	4,00
Ja/Yes	97983442 13	914587442 13	4,2x13	PH2	TX20	12	10	4,00
Ja/Yes	97983442 16	914587442 16	4,2x16	PH2	TX20	12	10	4,00
Ja/Yes	97983442 19	914587442 19	4,2x19	PH2	TX20	12	10	4,00
Ja/Yes	97983442 25	914587442 25	4,2x25	PH2	TX20	10	10	4,00
Ja/Yes	97983442 32	914587442 32	4,2x32	PH2	TX20	10	10	4,00
Nein/No	97983442 38	914587442 38	4,2x38	PH2	TX20	6	10	4,00
Nein/No	97983442 45	914587442 45	4,2x45	PH2	TX20	6	10	4,00
Nein/No	97983442 50	914587442 50	4,2x50	PH2	TX20	4	10	4,00
Nein/No	97983442 60	914587442 60	4,2x60	PH2	TX20	4	10	4,00
Ja/Yes	97983448 13	914587448 13	4,8x13	PH2	TX25	10	10	4,00
Nein/No	97983448 16	914587448 16	4,8x16	PH2	TX25	10	10	4,00
Ja/Yes	97983448 19	914587448 19	4,8x19	PH2	TX25	10	10	4,00
Ja/Yes	97983448 25	914587448 25	4,8x25	PH2	TX25	10	10	4,00
Ja/Yes	97983448 32	914587448 32	4,8x32	PH2	TX25	6	10	4,00
Nein/No	97983448 38	914587448 38	4,8x38	PH2	TX25	6	10	4,00
Nein/No	97983448 45	914587448 45	4,8x45	PH2	TX25	4	10	4,00
Nein/No	97983448 50	914587448 50	4,8x50	PH2	TX25	4	10	4,00
Nein/No	97983448 60	914587448 60	4,8x60	PH2	TX25	4	10	4,00
Ja/Yes	97983455 16	914587455 16	5,5x16	PH3	TX25	6	10	4,00
Nein/No	97983455 19	914587455 19	5,5x19	PH3	TX25	6	10	4,00
Ja/Yes	97983455 25	914587455 25	5,5x25	PH3	TX25	6	10	4,00
Ja/Yes	97983455 32	914587455 32	5,5x32	PH3	TX25	6	10	4,00
Ja/Yes	97983455 38	914587455 38	5,5x38	PH3	TX25	6	10	4,00
Nein/No	97983455 45	914587455 45	5,5x45	PH3	TX25	6	10	4,00

A4/AISI-316 Schrauben in SB-Verpackungen

Screws in self-service packages
Visserie sous blister en libre service

11

DIN 7983



ISO 14587



Blister Pack DIN 7983 / A4-AISI 316
Blechschaube, Linsensenkkopf
Tapping screw, raised countersunk head

DIN 7983
ISO 14587

Standard- bestückung Standard equipment	DIN Artikel-Nr. Item-no.	ISO Artikel-Nr. Item-no.	Abmessungen Dimensions	DIN Antrieb Drive	ISO Antrieb Drive	Inhalt Blister Box Pcs. Blister Box	VE** PU**	Preis*/Blisterbox Price*/Blister Box
Nein/No	97983455 50	914587455 50	5,5x50	PH3	TX25	4	10	4,00
Nein/No	97983455 60	914587455 60	5,5x60	PH3	TX25	4	10	4,00
Nein/No	97983455 70	914587455 70	5,5x70	PH3	TX25	4	10	4,00
Nein/No	97983463 19	914587463 19	6,3x19	PH3	TX30	6	10	4,00
Nein/No	97983463 25	914587463 25	6,3x25	PH3	TX30	6	10	4,00
Nein/No	97983463 38	914587463 38	6,3x38	PH3	TX30	6	10	4,00
Nein/No	97983463 50	914587463 50	6,3x50	PH3	TX30	4	10	4,00
Nein/No	97983463 60	914587463 60	6,3x60	PH3	TX30	4	10	4,00
Nein/No	97983463 80	914587463 80	6,3x80	PH3	TX30	4	10	4,00
Nein/No	97983463 90	914587463 90	6,3x90	PH3	TX30	4	10	4,00

11

DIN 95

Blister Pack DIN 95 / A4-AISI 316
Linsensenk-Holzschraube mit Schlitz
Slotted raised countersunk head wood screw



Standard- bestückung Standard equipment	DIN Artikel-Nr. Item-no.	Abmessungen Dimensions	Inhalt Blister Box Pcs. Blister Box	VE** PU**	Preis*/Blisterbox Price*/Blister Box
Ja/Yes	90095425 12	2,5x12	10	10	4,00
Ja/Yes	90095425 16	2,5x16	10	10	4,00
Ja/Yes	90095430 12	3,0x12	10	10	4,00
Ja/Yes	90095430 16	3,0x16	10	10	4,00
Ja/Yes	90095430 20	3,0x20	10	10	4,00
Ja/Yes	90095430 25	3,0x25	8	10	4,00
Ja/Yes	90095430 30	3,0x30	8	10	4,00
Ja/Yes	90095440 20	4,0x20	8	10	4,00
Ja/Yes	90095440 30	4,0x30	6	10	4,00
Ja/Yes	90095440 40	4,0x40	6	10	4,00
Ja/Yes	90095440 50	4,0x50	4	10	4,00
Nein/No	90095440 60	4,0x60	4	10	4,00
Ja/Yes	90095450 30	5,0x30	4	10	4,00
Ja/Yes	90095450 40	5,0x40	4	10	4,00
Ja/Yes	90095450 50	5,0x50	4	10	4,00
Ja/Yes	90095450 60	5,0x60	4	10	4,00
Nein/No	90095460 30	6,0x30	4	10	4,00
Nein/No	90095460 40	6,0x40	4	10	4,00
Nein/No	90095460 50	6,0x50	2	10	4,00
Ja/Yes	90095460 60	6,0x60	2	10	4,00
Ja/Yes	90095460 70	6,0x70	2	10	4,00

A4/AISI-316 Schrauben in SB-Verpackungen

Screws in self-service packages
Visserie sous blister en libre service

11



Blister Pack DIN 97 / A4-AISI 316
Senk-Holzschraube mit Schlitz
Slotted countersunk head wood screw

DIN 97

Standard- bestückung Standard equipment	DIN Artikel-Nr. Item-no.	Abmessungen Dimensions	Inhalt Blister Box Pcs. Blister Box	VE** PU**	Preis*/Blisterbox Price*/Blister Box
Ja/Yes	9009743 12	3,0x12	10	10	4,00
Ja/Yes	9009743 16	3,0x16	10	10	4,00
Ja/Yes	9009743 20	3,0x20	10	10	4,00
Ja/Yes	9009743 25	3,0x25	8	10	4,00
Ja/Yes	9009743 30	3,0x30	8	10	4,00
Ja/Yes	9009744 20	4,0x20	8	10	4,00
Ja/Yes	9009744 30	4,0x30	6	10	4,00
Ja/Yes	9009744 40	4,0x40	6	10	4,00
Ja/Yes	9009744 50	4,0x50	6	10	4,00
Ja/Yes	9009745 30	5,0x30	4	10	4,00
Ja/Yes	9009745 40	5,0x40	4	10	4,00
Ja/Yes	9009745 50	5,0x50	4	10	4,00
Ja/Yes	9009745 60	5,0x60	4	10	4,00
Nein/No	9009746 30	6,0x30	2	10	4,00
Ja/Yes	9009746 60	6,0x60	2	10	4,00
Ja/Yes	9009746 70	6,0x70	2	10	4,00

11

DIN 97

Blister Pack DIN 97 / Bronze

Senkholzschraube mit Schlitz
Slotted countersunk head wood screw



Standard- bestückung Standard equipment	DIN Artikel-Nr. Item-no.	Abmessungen Dimensions	Inhalt Blister Box Pcs. Blister Box	VE** PU**	Preis*/Blisterbox Price*/Blister Box
Ja/Yes	9009713 20	3,0x20	8	10	4,00
Ja/Yes	9009714 40	4,0x40	6	10	4,00
Ja/Yes	9009715 50	5,0x50	4	10	4,00
Ja/Yes	9009716 60	6,0x60	2	10	4,00

DIN 571

Blister Pack DIN 571 / A4-AISI 316

Sechskant-Holzschraube
Hexagon head wood screw



Standard- bestückung Standard equipment	DIN Artikel-Nr. Item-no.	Abmessungen Dimensions	DIN Antrieb Drive	Inhalt Blister Box Pcs. Blister Box	VE** PU**	Preis*/Blisterbox Price*/Blister Box
Nein/No	9057145 30	5,0x30	SW8	4	10	4,00
Nein/No	9057145 40	5,0x40	SW8	4	10	4,00
Nein/No	9057145 50	5,0x50	SW8	4	10	4,00
Nein/No	9057145 60	5,0x60	SW8	4	10	4,00
Nein/No	9057146 30	6,0x30	SW10	4	10	4,00
Nein/No	9057146 40	6,0x40	SW10	4	10	4,00
Ja/Yes	9057146 50	6,0x50	SW10	4	10	4,00
Ja/Yes	9057146 60	6,0x60	SW10	4	10	4,00
Ja/Yes	9057146 70	6,0x70	SW10	2	10	4,00
Ja/Yes	9057146 80	6,0x80	SW10	2	10	4,00
Nein/No	9057146 100	6,0x100	SW10	2	10	4,00
Nein/No	9057148 30	8,0x30	SW13	4	10	4,00
Nein/No	9057148 40	8,0x40	SW13	4	10	4,00
Nein/No	9057148 50	8,0x50	SW13	2	10	4,00
Ja/Yes	9057148 60	8,0x60	SW13	2	10	4,00
Ja/Yes	9057148 70	8,0x70	SW13	2	10	4,00
Ja/Yes	9057148 80	8,0x80	SW13	2	10	4,00
Nein/No	9057148 100	8,0x100	SW13	2	10	4,00

Art.-Nr.
1001

Blister Pack Art.-Nr. 1001 / A4-AISI 316

Stabdeckschraube mit TX-Antrieb, Flachsenskopf
Marine-woodfloor-screw with TX-Drive



Standard- bestückung Standard equipment	Artikel-Nr. Item-no.	Abmessungen Dimensions	Antrieb Drive	Kopfdurchmesser Diameter of head	Inhalt Blister Box Pcs. Blister Box	VE** PU**	Preis*/Blisterbox Price*/Blister Box
Nein/No	910014T42 16	4,2x16	TX20	8,75	15	10	4,00
Ja/Yes	910014T48 19	4,8x19	TX20	9,50	15	10	4,00

A4/AISI-316 Schrauben in SB-Verpackungen

Screws in self-service packages
Visserie sous blister en libre service

11



Blister Pack Art.-Nr. 1005 / A4-AISI 316
Spanplattenschraube Senkkopf mit PoziDrive-Kreuzschlitz
Chipboard screw countersunk head cross recessed

**Art.-Nr.
1005**

Standard- bestückung Standard equipment	Artikel-Nr. Item-no.	Abmessungen Dimensions		Inhalt Blister Box Pcs. Blister Box	VE** PU**	Preis*/Blisterbox Price*/Blister Box
Nein/No	91005430 16	3,0x16	PZ1	10	10	4,00
Ja/Yes	91005430 20	3,0x20	PZ1	10	10	4,00
Nein/No	91005430 25	3,0x25	PZ1	8	10	4,00
Ja/Yes	91005430 30	3,0x30	PZ1	8	10	4,00
Nein/No	91005430 40	3,0x40	PZ1	8	10	4,00
Nein/No	91005435 16	3,5x16	PZ2	8	10	4,00
Nein/No	91005435 30/18	3,5x30/18	PZ2	8	10	4,00
Nein/No	91005440 16	4,0x16	PZ2	8	10	4,00
Nein/No	91005440 20	4,0x20	PZ2	8	10	4,00
Nein/No	91005440 25	4,0x25	PZ2	8	10	4,00
Ja/Yes	91005440 30	4,0x30	PZ2	8	10	4,00
Nein/No	91005440 35	4,0x35	PZ2	6	10	4,00
Ja/Yes	91005440 40	4,0x40	PZ2	6	10	4,00
Nein/No	91005440 50	4,0x50	PZ2	4	10	4,00
Nein/No	91005440 60	4,0x60	PZ2	2	10	4,00
Nein/No	91005445 30/18	4,5x30/18	PZ2	6	10	4,00
Nein/No	91005445 40	4,5x40	PZ2	6	10	4,00
Nein/No	91005445 50	4,5x50	PZ2	4	10	4,00
Nein/No	91005450 20	5,0x20	PZ2	6	10	4,00
Nein/No	91005450 30	5,0x30	PZ2	4	10	4,00
Ja/Yes	91005450 40	5,0x40	PZ2	4	10	4,00
Ja/Yes	91005450 50	5,0x50	PZ2	4	10	4,00
Nein/No	91005450 60	5,0x60	PZ2	2	10	4,00
Nein/No	91005450 70	5,0x70	PZ2	2	10	4,00
Nein/No	91005450 80	5,0x80	PZ2	2	10	4,00
Nein/No	91005460 30	6,0x30	PZ3	4	10	4,00
Nein/No	91005460 40	6,0x40	PZ3	2	10	4,00
Nein/No	91005460 50	6,0x50	PZ3	2	10	4,00
Ja/Yes	91005460 60	6,0x60	PZ3	2	10	4,00
Nein/No	91005460 80	6,0x80	PZ3	2	10	4,00



Blister Pack Art.-Nr. 1008 / A4-AISI 316
Scharnierbandschraube, 5mm Kopf
Hinge tape chipboard screw, head 5mm

**Art.-Nr.
1008**

Standard- bestückung Standard equipment	Artikel-Nr. Item-no.	Abmessungen Dimensions	DIN Antrieb Drive	Inhalt Blister Box Pcs. Blister Box	VE** PU**	Preis*/Blisterbox Price*/Blister Box
Ja/Yes	9100843 12	3,0x12	PZ1	10	10	4,00
Ja/Yes	9100843 16	3,0x16	PZ1	10	10	4,00
Ja/Yes	9100843 20	3,0x20	PZ1	10	10	4,00

11

DIN 934

Blister Pack DIN 934 / A4-AISI 316

Sechskantmutter
Hexagon nut



Standard- bestückung Standard equipment	DIN Artikel-Nr. Item-no.	Abmessungen Dimensions	DIN Antrieb Drive	Höhe Height	Inhalt Blister Box Pcs. Blister Box	VE** PU**	Preis*/Blisterbox Price*/Blister Box
Ja/Yes	9093443	M3	SW5,5	2,4	15	10	4,00
Ja/Yes	9093444	M4	SW7	3,2	15	10	4,00
Ja/Yes	9093445	M5	SW8	4,0	15	10	4,00
Ja/Yes	9093446	M6	SW10	5,0	10	10	4,00
Ja/Yes	9093448	M8	SW13	6,5	5	10	4,00
Nein/No	90934410	M10	SW17	8,0	4	10	4,00
Nein/No	90934412	M12	SW19	10,0	4	10	4,00
Nein/No	90934414	M14	SW22	11,0	4	10	4,00

DIN 982

Blister Pack DIN 982 / A4-AISI 316

Sechskantmutter, Poly-Stop, hohe Form
Self-locking hexagon nut, high type



Standard- bestückung Standard equipment	DIN Artikel-Nr. Item-no.	Abmessungen Dimensions	DIN Antrieb Drive	Höhe Height	Inhalt Blister Box Pcs. Blister Box	VE** PU**	Preis*/Blisterbox Price*/Blister Box
Nein/No	9098245	M5	SW8	6,3	6	10	4,00
Nein/No	9098246	M6	SW10	8,0	4	10	4,00
Nein/No	9098248	M8	SW13	9,5	4	10	4,00
Nein/No	90982410	M10	SW17	11,5	2	10	4,00
Nein/No	90982412	M12	SW19	14,0	1	10	4,00

DIN 985

Blister Pack DIN 985 / A4-AISI 316

Sechskantmutter, Poly-Stop, niedrige Form
Self-locking hexagon nut, low type



Standard- bestückung Standard equipment	DIN Artikel-Nr. Item-no.	Abmessungen Dimensions	DIN Antrieb Drive	Höhe Height	Inhalt Blister Box Pcs. Blister Box	VE** PU**	Preis*/Blisterbox Price*/Blister Box
Ja/Yes	9098543	M3	SW5,5	4,0	6	10	4,00
Ja/Yes	9098544	M4	SW7	5,0	6	10	4,00
Ja/Yes	9098545	M5	SW8	5,0	6	10	4,00
Ja/Yes	9098546	M6	SW10	6,0	4	10	4,00
Ja/Yes	9098548	M8	SW13	8,0	4	10	4,00
Nein/No	90985410	M10	SW17	10,0	2	10	4,00
Nein/No	90985412	M12	SW19	12,0	1	10	4,00
Nein/No	90985414	M14	SW22	14,0	1	10	4,00

A4/AISI-316 Schrauben in SB-Verpackungen

Screws in self-service packages
Visserie sous blister en libre service

11



Blister Pack DIN 1587 / A4-AISI 316
Sechskant-Hutmutter, hohe Form
Hexagon dome cap nut, high type

DIN 1587

Standard- bestückung Standard equipment	DIN Artikel-Nr. Item-no.	Abmessungen Dimensions	DIN Antrieb Drive	Höhe Height	Inhalt Blister Box Pcs. Blister Box	VE** PU**	Preis*/Blisterbox Price*/Blister Box
Ja/Yes	9158743	M3	SW5,5	7,0	4	10	4,00
Ja/Yes	9158744	M4	SW7	8,0	4	10	4,00
Ja/Yes	9158745	M5	SW8	10,0	4	10	4,00
Ja/Yes	9158746	M6	SW10	12,0	3	10	4,00
Ja/Yes	9158748	M8	SW13	15,0	3	10	4,00
Nein/No	91587410	M10	SW17	18,0	1	10	4,00
Nein/No	91587412	M12	SW19	22,0	1	10	4,00



Blister Pack DIN 6926 / A4-AISI 316
Flanschmutter selbstsichernd mit Sperrverzahnung
Flange nut self-locked with serration

DIN 6926

Standard- bestückung Standard equipment	DIN Artikel-Nr. Item-no.	Abmessungen Dimensions	DIN Antrieb Drive	Höhe Height	Inhalt Blister Box Pcs. Blister Box	VE** PU**	Preis*/Blisterbox Price*/Blister Box
Nein/No	9692644	M4	SW7	4,65	6	10	4,00
Nein/No	9692645	M5	SW8	4,7	6	10	4,00
Nein/No	9692646	M6	SW10	5,7	4	10	4,00
Nein/No	9692648	M8	SW13	7,6	4	10	4,00
Nein/No	96926410	M10	SW15	9,6	2	10	4,00
Nein/No	96926412	M12	SW18	11,6	1	10	4,00



Blister Pack DIN 315 / A4-AISI 316
Flügelmutter, amerikanische Form
Wing nut, american type

DIN 315

Standard- bestückung Standard equipment	DIN Artikel-Nr. Item-no.	Abmessungen Dimensions	Inhalt Blister Box Pcs. Blister Box	VE** PU**	Preis*/Blisterbox Price*/Blister Box
Ja/Yes	9031543	M3	4	10	4,00
Ja/Yes	9031544	M4	4	10	4,00
Ja/Yes	9031545	M5	4	10	4,00
Ja/Yes	9031546	M6	2	10	4,00
Ja/Yes	9031548	M8	2	10	4,00
Nein/No	90315410	M10	1	10	4,00
Nein/No	90315412	M12	1	10	4,00

11

Art.-Nr. 1004

Blister Pack Art.-Nr. 1004 / A4-AISI 316
Hülsenmutter mit Linsensenkopf und Schlitz
Raised countersunk head sleeve nuts with slot



Standard- bestückung Standard equipment	Artikel-Nr. Item-no.	Abmessungen Dimensions	L	D1	Inhalt Blister Box Pcs. Blister Box	VE** PU**	Preis*/Blisterbox Price*/Blister Box
Ja/Yes	9100424	M4	12,0	5,0	4	10	4,00
Ja/Yes	9100425	M5	15,0	6,0	4	10	4,00
Ja/Yes	9100426	M6	15,0	7,5	3	10	4,00
Ja/Yes	9100428	M8	20,0	14,0	2	10	4,00

DIN 125

Blister Pack DIN 125 / A4-AISI 316
Unterlegscheibe, klein
Washer, small



Standard- bestückung Standard equipment	DIN Artikel-Nr. Item-no.	Abmessungen Dimensions	D	S	Inhalt Blister Box Pcs. Blister Box	VE** PU**	Preis*/Blisterbox Price*/Blister Box
Ja/Yes	90125432	3,2	7	0,5	20	10	4,00
Ja/Yes	90125443	4,3	9	0,8	20	10	4,00
Ja/Yes	90125453	5,3	10	1,0	20	10	4,00
Ja/Yes	90125464	6,4	12	1,6	20	10	4,00
Ja/Yes	90125484	8,4	16	1,6	20	10	4,00
Nein/No	901254105	10,5	20	2,0	10	10	4,00
Nein/No	901254130	13,0	24	2,5	10	10	4,00

DIN 127

Blister Pack DIN 127 / A4-AISI 316
Federring
Spring lock washer



Standard- bestückung Standard equipment	DIN Artikel-Nr. Item-no.	Abmessungen Dimensions	D	S	Inhalt Blister Box Pcs. Blister Box	VE** PU**	Preis*/Blisterbox Price*/Blister Box
Ja/Yes	9012743	3,1	6,2	0,8	20	10	4,00
Ja/Yes	9012744	4,1	7,6	0,9	20	10	4,00
Ja/Yes	9012745	5,1	9,2	1,2	20	10	4,00
Ja/Yes	9012746	6,1	11,8	1,6	20	10	4,00
Ja/Yes	9012748	8,1	14,8	2,0	20	10	4,00
Nein/No	90127410	10,2	18,1	2,2	20	10	4,00
Nein/No	90127412	12,2	21,1	2,5	12	10	4,00

A4/AISI-316 Schrauben in SB-Verpackungen

Screws in self-service packages
Visserie sous blister en libre service

11



Blister Pack Art.-Nr. 1011 / A4-AISI 316
Rosette, aus Vollmaterial gedreht
Rosette turned full body

**Art.-Nr.
1011**

Standard- bestückung Standard equipment	Artikel-Nr. Item-no.	Abmessungen Dimensions	D	H	Inhalt Blister Box Pcs. Blister Box	VE** PU**	Preis*/Blisterbox Price*/Blister Box
Ja/Yes	9101143	3,5	9	2,0	5	10	4,00
Ja/Yes	9101144	4,3	11	2,5	4	10	4,00
Ja/Yes	9101145	5,3	14	3,0	4	10	4,00
Ja/Yes	9101146	6,4	16	3,5	3	10	4,00
Ja/Yes	9101148	8,5	22	4,5	2	10	4,00
Nein/No	91011410	11,0	28	5,5	2	10	4,00



Blister Pack DIN 6798 / A4-AISI 316
Fächerscheibe, Form V
Serrated countersunk lock washer, type V

DIN 6798

Standard- bestückung Standard equipment	DIN Artikel-Nr. Item-no.	Abmessungen Dimensions	D		Inhalt Blister Box Pcs. Blister Box	VE** PU**	Preis*/Blisterbox Price*/Blister Box
Nein/No	967984043	4,3	8		20	10	4,00
Nein/No	967984053	5,3	10		20	10	4,00
Nein/No	967984064	6,4	11		20	10	4,00
Nein/No	967984082	8,2	14		20	10	4,00
Nein/No	967984084	8,4	15		20	10	4,00
Nein/No	9679840105	10,5	18		10	10	4,00



Blister Pack DIN 9021 / A4-AISI 316
Unterlegscheibe, groß
Washer, large

DIN 9021

Standard- bestückung Standard equipment	DIN Artikel-Nr. Item-no.	Abmessungen Dimensions	D	S	Inhalt Blister Box Pcs. Blister Box	VE** PU**	Preis*/Blisterbox Price*/Blister Box
Ja/Yes	99021432	3,2	9	0,8	20	10	4,00
Ja/Yes	99021443	4,3	12	1,0	20	10	4,00
Ja/Yes	99021453	5,3	15	1,2	20	10	4,00
Ja/Yes	99021464	6,4	18	1,8	20	10	4,00
Ja/Yes	99021484	8,4	24	2,0	10	10	4,00
Nein/No	990214105	10,5	30	2,5	4	10	4,00
Nein/No	990214130	13,0	37	3,0	2	10	4,00
Nein/No	990214150	15,0	44	3,0	2	10	4,00
Nein/No	990214170	17,0	50	3,0	2	10	4,00

11

Art.-Nr.
8383
Blister Pack Art.-Nr. 8383 / A4-AISI 316
 Ringsplint
 Ringpin

Standard- bestückung Standard equipment	Artikel-Nr. Item-no.	Abmessungen Dimensions	Inhalt Blister Box Pcs. Blister Box	VE** PU**	Preis*/Blisterbox Price*/Blister Box
Nein/No	98383410 10	1,0x10	10	10	4,00
Nein/No	98383412 15	1,2x15	10	10	4,00
Nein/No	98383415 20	1,5x20	10	10	4,00
Nein/No	98383418 25	1,8x25	10	10	4,00

DIN 94
Blister Pack DIN 94 / A4-AISI 316
 Splint
 Split pin

Standard- bestückung Standard equipment	DIN Artikel-Nr. Item-no.	Abmessungen Dimensions	Inhalt Blister Box Pcs. Blister Box	VE** PU**	Preis*/Blisterbox Price*/Blister Box
Nein/No	90094420 10	2,0x10	10	10	4,00
Nein/No	90094420 12	2,0x12	10	10	4,00
Nein/No	90094420 16	2,0x16	10	10	4,00
Ja/Yes	90094420 20	2,0x20	12	10	4,00
Nein/No	90094420 22	2,0x22	10	10	4,00
Nein/No	90094420 25	2,0x25	10	10	4,00
Nein/No	90094420 32	2,0x32	10	10	4,00
Nein/No	90094420 40	2,0x40	8	10	4,00
Nein/No	90094425 16	2,5x16	10	10	4,00
Ja/Yes	90094425 20	2,5x20	10	10	4,00
Nein/No	90094425 22	2,5x22	10	10	4,00
Nein/No	90094425 25	2,5x25	10	10	4,00
Nein/No	90094425 32	2,5x32	10	10	4,00
Nein/No	90094432 16	3,2x16	10	10	4,00
Nein/No	90094432 20	3,2x20	10	10	4,00
Ja/Yes	90094432 25	3,2x25	8	10	4,00
Nein/No	90094432 32	3,2x32	8	10	4,00
Ja/Yes	90094432 40	3,2x40	6	10	4,00
Nein/No	90094432 45	3,2x45	8	10	4,00
Nein/No	90094432 50	3,2x50	8	10	4,00
Nein/No	90094440 20	4,0x20	8	10	4,00
Nein/No	90094440 25	4,0x25	8	10	4,00
Nein/No	90094440 32	4,0x32	6	10	4,00
Nein/No	90094440 40	4,0x40	5	10	4,00
Nein/No	90094440 45	4,0x45	5	10	4,00
Ja/Yes	90094440 50	4,0x50	4	10	4,00
Nein/No	90094450 32	5,0x32	6	10	4,00
Nein/No	90094450 45	5,0x45	6	10	4,00
Nein/No	90094450 50	5,0x50	5	10	4,00
Nein/No	90094450 56	5,0x56	5	10	4,00

A4/AISI-316 Schrauben in SB-Verpackungen

Screws in self-service packages
Visserie sous blister en libre service

11



Blister Pack DIN 7337 / Monel
Blindniete, Flachkopf
Blind rivet, flat head

DIN 7337

Standard- bestückung Standard equipment	DIN Artikel-Nr. Item-no.	Abmessungen Dimensions	Klemmbereich Clamping area	Inhalt Blister Box Pcs. Blister Box	VE** PU**	Preis*/Blisterbox Price*/Blister Box
Ja/Yes	97337932 105	3,2x10,5	5,8-7,1	3	10	4,00
Nein/No	9733794 61	4,0x6,1	1,3-2,5	3	10	4,00
Nein/No	9733794 76	4,0x7,6	2,5-4,1	3	10	4,00
Nein/No	9733794 94	4,0x9,4	4,1-5,8	3	10	4,00
Nein/No	9733794 102	4,0x10,2	5,8-6,6	3	10	4,00
Ja/Yes	9733794 114	4,0x11,4	6,6-7,9	2	10	4,00
Ja/Yes	97337948 19	4,8x19,0	12,5-15,0	1	10	4,00
Nein/No	97337948 61	4,8x6,1	0,5-2,3	3	10	4,00
Nein/No	97337948 76	4,8x7,6	2,3-2,8	2	10	4,00
Nein/No	97337948 91	4,8x9,1	3,8-5,1	2	10	4,00
Nein/No	97337948 98	4,8x9,8	5,1-5,8	2	10	4,00
Nein/No	97337948 127	4,8x12,7	5,8-8,6	1	10	4,00
Nein/No	97337948 165	4,8x16,5	8,6-12,5	1	10	4,00
Nein/No	97337964 125	6,4x12,5	4,0-7,6	1	10	4,00
Nein/No	97337964 178	6,4x17,8	8,4-13,5	1	10	4,00

11

ISO 4027

Blister Pack ISO 4027 / A4-AISI 316
Gewindestifte mit Innensechskant und Spitze
Hexagon socket set screw with cone point



Standard- bestückung Standard equipment	ISO Artikel-Nr. Item-no.	Abmessungen Dimensions	ISO Antrieb Drive	Inhalt Blister Box Pcs. Blister Box	VE** PU**	Preis*/Blisterbox Price*/Blister Box
Nein/No	9402745 5	M5x5	SW2,5	6	10	4,00
Nein/No	9402746 6	M6x6*	SW3	6	10	4,00
Nein/No	9402746 10	M6x10	SW3	4	10	4,00
Nein/No	9402746 12	M6x12	SW3	4	10	4,00
Nein/No	9402746 16	M6x16	SW3	4	10	4,00
Nein/No	9402746 20	M6x20	SW3	3	10	4,00

* Passend für Relings-/Rohrbeschläge. Siehe Kapitel 4 - Seite 95-148.

* Fits for rail and tube fittings. See chapter 4 - page 95-148.

ISO 4029

Blister Pack ISO 4029 / A4-AISI 316
Gewindestifte mit Innensechskant und Ringschneide
Hexagon socket set screw with cup point



Standard- bestückung Standard equipment	ISO Artikel-Nr. Item-no.	Abmessungen Dimensions	ISO Antrieb Drive	Inhalt Blister Box Pcs. Blister Box	VE** PU**	Preis*/Blisterbox Price*/Blister Box
Nein/No	9402946 6	M6x6	SW3	6	10	4,00
Nein/No	9402946 10	M6x10	SW3	4	10	4,00

Schrauben in Großpackungen

Screws in bulk packs

Visserie en gros conditionnement

Kapitel 12

Chapter 12

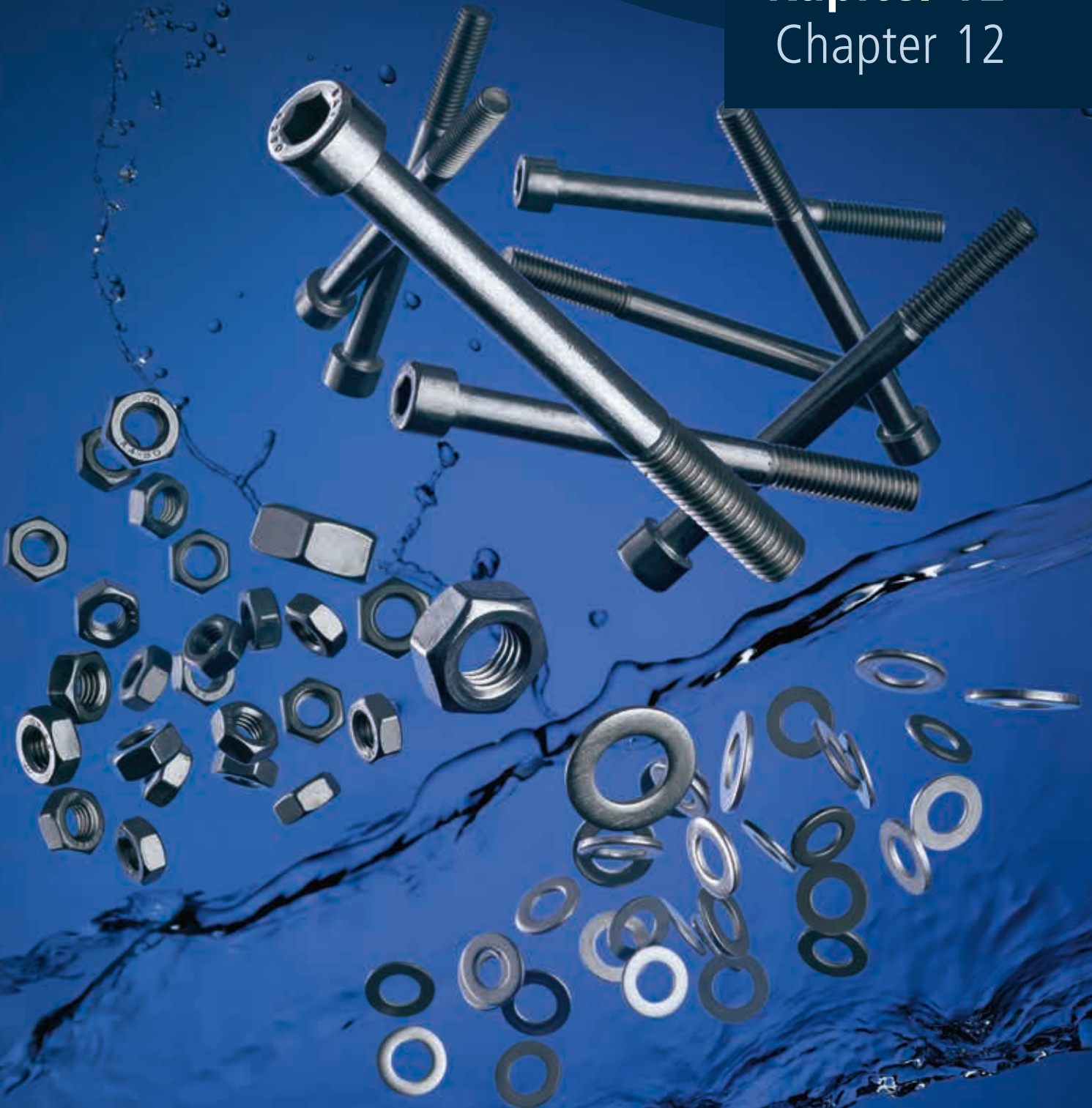

ISO 16584

Blindniete Monel mit A4 Dorn ISO 16584 / Monel-A4

Blind rivets Monel with A4 mandrel ISO 16584 / Rivet aveugle Monel avec tige an A4 ISO 16584

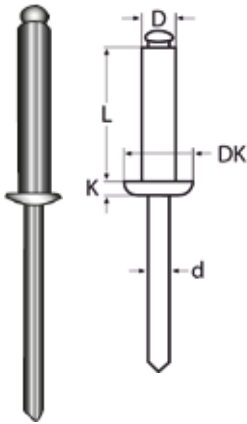

Artikel-Nr. Item-no.	D	L	DK	K	d	Klemmbereich Clamping area	Scherkraft N Shear force N	Zugkraft N Tensile strenght N	Box	*€/Stück *€/piece
16584932 06	3,2	6	6,5	0,8	1,9	1,0-3,0	1600	2400	100	0,36
16584932 08	3,2	8	6,5	0,8	1,9	3,0-5,0	1600	2400	100	0,38
16584932 10	3,2	10	6,5	0,8	1,9	5,0-7,0	1600	2400	100	0,39
16584940 06	4,0	6	8,0	1,0	2,3	1,0-3,0	2300	3450	100	0,42
16584940 08	4,0	8	8,0	1,0	2,3	3,0-5,0	2300	3450	100	0,44
16584940 10	4,0	10	8,0	1,0	2,3	5,0-7,0	2300	3450	100	0,47
16584940 12	4,0	12	8,0	1,0	2,3	7,0-9,0	2300	3450	100	0,50
16584948 08	4,8	8	9,5	1,1	2,9	2,0-4,0	3400	5000	100	0,68
16584948 10	4,8	10	9,5	1,1	2,9	4,0-6,0	3400	5000	100	0,72
16584948 12	4,8	12	9,5	1,1	2,9	6,0-8,0	3400	5000	100	0,75
16584948 16	4,8	16	9,5	1,1	2,9	10,0-12,0	3400	5000	100	0,85
16584948 20	4,8	20	9,5	1,1	2,9	14,0-16,0	3400	5000	100	0,97
16584964 12	6,4	12	13	1,8	3,8	4,0-6,0	5400	8200	50	1,34
16584964 16	6,4	16	13	1,8	3,8	7,0-10,0	5400	8200	50	1,60
16584964 18	6,4	18	13	1,8	3,8	9,0-12,0	5400	8200	50	1,70

Verwenden Sie einen Bohrer der 0,1mm größer ist als Maß D.

Use a drill of size 0,1mm larger then size D.

Utilisez une perceuse + 0,1 mm plus grande que dimension D.

Art.-Nr.
0057

DIN 97 TX-Antrieb / Kupfer

DIN 97 TX-Drive / Copper / DIN 97 ; forme d'entrainement TX, cuivre



Artikel-Nr. Item-no.	Abmessungen Dimensiones	Antrieb Drive	Box	*€/Stück *€/piece
005713 12	3,0x12	TX10	200	0,20
0057135 16	3,5x16	TX15	200	0,23
0057135 18	3,5x18	TX15	200	0,26
0057135 20	3,5x20	TX15	200	0,29
0057135 25	3,5x25	TX15	200	0,31
0057135 30	3,5x30	TX15	200	0,34
0057135 35	3,5x35	TX15	200	0,37
005714 20	4,0x20	TX15	200	0,40
005714 25	4,0x25	TX15	200	0,43
005714 30	4,0x30	TX15	200	0,46
005714 35	4,0x35	TX15	200	0,49
005714 40	4,0x40	TX15	200	0,52
005714 50	4,0x50	TX15	200	0,55
0057145 40	4,5x40	TX20	200	0,58
0057145 45	4,5x45	TX20	200	0,61
0057145 50	4,5x50	TX20	200	0,64
0057145 60	4,5x60	TX20	200	0,67



Linsenkopf-Blechschaube / Duplex D6-AISI-318LN
Pan head tapping screw / Vis à tôle TCB à six lobes

ISO 14585

Artikel-Nr. Item-no.	d	L	Antrieb Drive	Box	*€/Stück *€/piece
14585446229 XX	2,9	9,5 - 32	TX10	1000	- *
14585446235 XX	3,5	9,5 - 38	TX15	1000	- *
14585446239 XX	3,9	9,5 - 50	TX15	500-1000	- *
14585446242 XX	4,2	9,5 - 45	TX20	500-1000	- *
14585446248 XX	4,8	13 - 45	TX25	200-1000	- *
14585446255 XX	5,5	13 - 50	TX25	200-1000	- *
14585446263 XX	6,3	13 - 60	TX30	200-500	- *

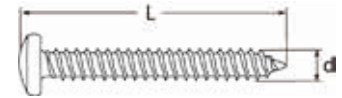

* auf Anfrage
on request
sur demande



Senkkopf-Blechschaube / Duplex D6-AISI-318LN
Countersunk head tapping screw / Vis à tôle à tête fraisée à six lobes

ISO 14586

Artikel-Nr. Item-no.	d	L	Antrieb Drive	Box	*€/Stück *€/piece
14586446229 XX	2,9	9,5 - 32	TX10	1000	- *
14586446235 XX	3,5	9,5 - 38	TX15	1000	- *
14586446239 XX	3,9	9,5 - 38	TX15	500-1000	- *
14586446242 XX	4,2	9,5 - 45	TX20	500-1000	- *
14586446248 XX	4,8	13 - 45	TX25	200-1000	- *
14586446255 XX	5,5	13 - 50	TX25	200-1000	- *
14586446263 XX	6,3	13 - 60	TX30	200-500	- *

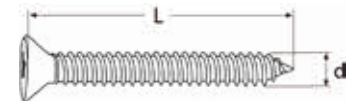

* auf Anfrage
on request
sur demande

Einschlagmutter / A2-AISI 304
Drive-in nut / L'écrou à enfoncer

9260

Artikel-Nr. Item-no.	GW	H	D	D1	Box	*€/Stück *€/piece
926024 7	M4	7	15	5,2	100	0,40
926025 8	M5	8	17	6,2	100	0,50
926026 9	M6	9	19	7,5	100	0,60
926028 11	M8	11	22	10,0	100	0,70
9260210 12	M10	12	25	11,5	100	0,80
9260212 13	M12	13	27	14,5	100	0,90

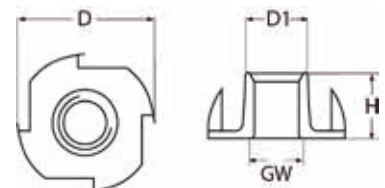

815028

Gewindeinsatz, made in Germany / A4-AISI 316

Thread insert / Insert de pont

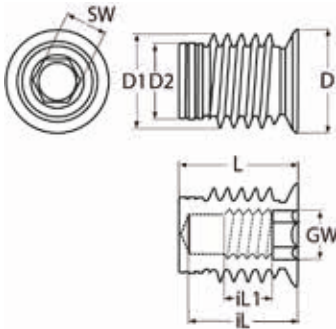

Artikel-Nr. Item-no.	GW	L	iL	iL1	D	D1	D2	Antrieb Drive	Box	*€/Stück *€/piece
815028406	M6	25,0	23,0	18,0	18	16	12	SW5	2	18,00
815028408	M8	25,0	23,0	18,0	20	18	14	SW7	2	19,00
815028410	M10	25,5	23,0	18,0	20	20	16	SW9	2	21,00
815028412	M12	30,0	27,5	23,5	22	22	18	SW10	2	22,00

814856

Keilsicherungsscheiben, schmal / 1.4547 (SMO254)

Wedge lock washers, standard / Rondelle de blocage de coin, étroites



Artikel-Nr. Item-no.	iD	D	S	Box	*€/Stück *€/piece
81485615065	6,5	10,8	2	20	1,60
81485615087	8,7	13,5	2	20	1,90
81485615107	10,7	16,6	2	20	2,10
81485615130	13,0	19,5	2	10	4,00
81485615170	17,0	25,4	3	10	7,20
81485615214	21,4	30,7	3	10	10,20
81485615253	25,3	39,0	3	10	23,60



Technische Informationen
Technical information
Informations techniques

Der Werkstoff 1.4547 ist besonders seewasserbeständig. 3000 Std. Salzwassersprühtest wurden ohne Korrosion überstanden.

Material 1.4547 is especially seawater resistant. Passed 3000 h of salt water spray test without corrosion.

Le matériau 1.4547 est particulièrement résistant à l'eau de mer. 3000 heures d'essai au brouillard d'eau salée ont été résistées sans corrosion.

Keilsicherungsscheiben, breit / 1.4547 (SMO254)
Wedge lock washers, wide / Rondelle de blocage de coin, large

814857

Artikel-Nr. Item-no.	iD	D	S	Box	*€/Stück *€/piece
81485715065	6,5	13,5	2	20	2,30
81485715087	8,7	16,6	2	20	2,80
81485715107	10,7	21,0	2	20	4,60
81485715130	13,0	25,4	2	10	10,70
81485715170	17,0	30,7	3	10	11,80
81485715214	21,4	39,0	3	10	26,20
81485715253	25,3	48,5	3	10	75,60

Der Werkstoff 1.4547 ist besonders seewasserbeständig. 3000 Std. Salzwassersprühtest wurden ohne Korrosion überstanden.

Material 1.4547 is especially seawater resistant. Passed 3000 h of salt water spray test without corrosion.

Le matériau 1.4547 est particulièrement résistant à l'eau de mer. 3000 heures d'essai au brouillard d'eau salée ont été résistantes sans corrosion.



Technische Informationen
Technical information
Informations techniques

Funktionsprinzip

Ein wichtiger Unterschied der HEICO-LOCK® Keilsicherungssysteme zu anderen bereits erhältlichen Systemen, ist die Sicherung der Schraubenverbindung durch Vorspannkraft anstatt durch Reibung.

- Keifflächen auf den Innenseiten der Sicherungsscheiben, Radialrippen auf den Außenseiten
- formschlüssiges Einprägen der Radialrippen in die jeweilige gegenauflage (beim Anziehen der Schraubenverbindung)
- Systembewegung nur über die innenliegenden Keifflächen möglich, dadurch Selbsthemmung infolge des Keileffekts
- Erhöhung der Klemmkraft

Principle of operation











An important difference between the HEICO-LOCK® wedge safety systems and other systems already available is the securing of the screwed connection by means of pretensioning rather than friction.

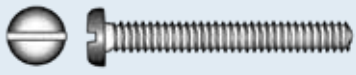







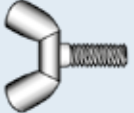
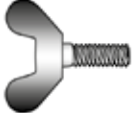

- Wedge surfaces on the inner sides of the securing discs, radial ribs on the outer sides
- Form-fitting embossing of the radial ribs into the respective counter-support (when tightening the screw connection)
- System movement possible only via the inner wedge surfaces, thereby self-locking due to the wedge effect
- Increasing the clamping force

Principe de fonctionnement





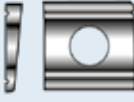



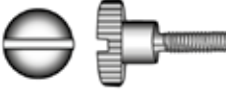



Une différence importante entre les systèmes de verrouillage à coin HEICO-LOCK® et d'autres systèmes déjà disponibles, est la sécurisation du raccordement vissé par force de précontrainte au lieu de friction.







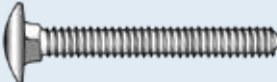

- Surfaces de coin à l'intérieur des rondelles de blocage, nervures radiales les extérieurs
- Gaufrage moulé des nervures radiales dans le contre-support respectif (lors du serrage du raccord à vis)
- Le mouvement du système n'est possible que via les surfaces internes du coin, Autobloquant grâce à l'effet de coin
- Augmentation de la force de serrage

	DIN / ISO Art-Nr.	Bezeichnung Description	Werkstoff Material	
	DIN 1 ISO 2339	Kegelstifte, Form B (Toleranzfeld h10) Taper pins Goupilles coniques	A1	A5
	DIN 7 ISO 2338	Zylinderstifte, Form A (Toleranzfeld m6) Parallel pins Goupilles cylindriques	A1	A4
	DIN 84 ISO 1207	Zylinderschrauben mit Schlitz Slotted cheese head screws Vis à tête cylindrique fendue	A2	A4
	DIN 85 ISO 1580	Flachkopfschrauben mit Schlitz Slotted pan head screws Vis à tête bombée fendues	A2	A4 A5
	DIN 93	Sicherheitsbleche mit 1 Lappen Tab washers with 1 tab Freins d'écrous à un aileron	A2	A4
	DIN 94 ISO 1234	Splinte Split pins Goupilles fendues	A2	A4
	DIN 95	Linsensenk-Holzschrauben mit Schlitz Slotted raised countersunk head wood screws Vis à bois à tête fendue fraisée bombée	A2	A4
	DIN 96	Halbrund-Holzschrauben mit Schlitz Slotted round head wood screws Vis à bois à tête ronde fendue	A2	A4
	DIN 97	Senk-Holzschrauben mit Schlitz Slotted countersunk head wood screws Vis à bois à tête fendue fraisée	A2	A4
	DIN 125 ISO 7089 ISO 7090	Scheiben Form A / Form B Washers type A / type B Rondelles plates, type A / type B	A2	A4 A5
	DIN 127	Federringe Form B (glatt) Flat spring lock washers, type B Rondelle élastiques sans becs, type B	A1	A4 A5
	DIN 128	Federringe Form A (gewölbt) Curved spring lock washers, type A Rondelles élastiques cintrées, type A	A1	A4
	DIN 137	Federscheiben Form A (gewölbt) Curved spring washers type A Rondelles élastiques cintrées, type A	A1	











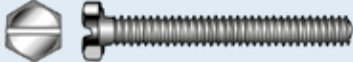

	DIN / ISO Art-Nr.	Bezeichnung Description	Werkstoff Material	
	DIN 137	Federscheiben Form B (gewellt) Wave spring washers, type B Rondelles élastiques ondulées, type B	A1	A4
	Art. 315	Flügelmuttern, amerikanische Form Wing nuts, American Ecrous à oreilles, type américain	A2	A4
	DIN 315	Flügelmuttern, deutsche Form Wing nuts, german type Ecrous à oreilles, type allemand	A2	A4
	Art. 316	Flügelschrauben, amerikanische Form Wing screws, American Vis à oreilles, type américain	A2	A4
	DIN 316	Flügelschrauben, deutsche Form Wing screws, german type Vis à oreilles, type allemand	A2	A4
	DIN 404	Kreuzlochschrauben mit Schlitz Capstan screws, slotted Vis de plombage avec fente	A1	
	DIN 417 ISO 7435	Gewindestifte mit Schlitz und Zapfen Slotted set screws with long dog point Vis sans tête, fendues, à têtton long	A2	A4
	DIN 427 ISO 2342	Schaftschrauben mit Schlitz und Kegelkuppe Slotted headless screws with chamfered end Vis sans tête, partiellement filetées, à bout chanfreiné	A1	A4
	DIN 431	Rohrmuttern mit Rohrgewinde nach DIN ISO 228, Form B Pipe nuts with thread according to DIN ISO 228, type B Ecrous six pans, filet à gaz, à la DIN ISO 228, type B	A2	A4
	DIN 432	Sicherungsbleche mit Nase Washers with external tab Freins d'écrous avec ergot extérieur	A2	A4
	DIN 433 ISO 7092	Scheiben für Zylinderschrauben Washers for cheese head screws Rondelles pour vis à tête cylindrique	A2	A4
	DIN 434	Vierkant-Keilscheiben für U-Träger, Neigung 8% Square taper washers for U-sections Plaque oblique pour profilés en U	A2	A4
	DIN 435	Vierkant-Keilscheiben für I-Träger, Neigung 14% Square taper washers for I-sections Plaque oblique pour profilés en I	A2	A4

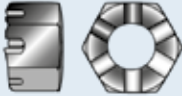





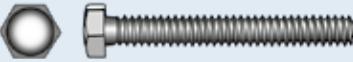



	DIN / ISO Art-Nr.	Bezeichnung Description	Werkstoff Material	
	DIN 436	Vierkantscheiben für Holzkonstruktionen Square washers for wood constructions Rondelles carrées pour constructions en bois	A2	A4
	DIN 438 ISO 7436	Gewindestifte mit Schlitz und Ringschneide Slotted set screws with cup point Vis sans tête, fendues, à bout cuvette	A2	A4
	DIN 439 ISO 4035	Sechskantmuttern, niedrige Form, Form B (mit Fase) Hexagon thin nuts, type B Écrous hexagonal, bas (avec chanfrein), type B	A2	A4
	DIN 439 ISO 4035	Sechskantmuttern, niedrige Form, Feingewinde, Form B (mit Fase) Hexagon thin nuts, fine pitch, type B Écrous bas hexagonaux, filet fin métrique (avec chanfrein), type B	A2	A4
	DIN 439 ISO 4035	Sechskantmuttern, niedrige Form, Linksgewinde, Form B (mit Fase) Hexagon thin nuts left hand thread, type B Écrous hexagonal, bas, filetage à gauche, type B	A2	A4
	DIN 440 ISO 7094	Scheiben für Holzkonstruktionen, Form R = Rundloch Washers, especially for wood constructions, type R Rondelles, principalement pour constructions en bois type R	A2	A4
	DIN 440 ISO 7094	Scheiben für Holzkonstruktionen, Form V = Vierkantloch Washers, especially for wood constructions, type V Rondelles, principalement pour constructions en bois type V	A2	A4
	DIN 444	Augenschrauben, Form B Eye bolts, type B Vis à oeillet, type B	A2	A4
	DIN 463	Sicherungsbleche mit 2 Lappen Tab washers with 2 tabs Freins d'écrous à 2 ailerons d'équerre	A2	A4
	DIN 464	Rändelschrauben, hohe Form Knurled thumb screws, high type Vis moletées, type haut	A1	
	DIN 465	Rändelschrauben, hohe Form, mit Schlitz Slotted knurled thumb screws, high type Vis moletées, type haute, avec fente	A1	
	DIN 466	Rändelmuttern, hohe Form Knurled thumb nuts, high type Ecrous moletées, type haut	A1	
	DIN 467	Rändelmuttern, niedrige Form Knurled thumb nuts, thin type Ecrous moletées, type bas	A1	

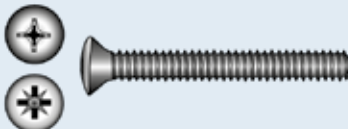











	DIN / ISO Art-Nr.	Bezeichnung Description	Werkstoff Material	
	DIN 471	Sicherungsringe für Wellen Retaining rings for shafts Circlips extérieurs	A1	
	DIN 472	Sicherungsringe für Bohrungen Retaining rings for bores Circlips intérieurs	A1	
	DIN 546	Schlitzmuttern Slotted round nuts Ecrous cylindriques à fente	A1	A4
	DIN 551 ISO 4766	Gewindestifte mit Schlitz und Kegelkuppe Slotted set screws with flat point Vis sans tête avec fente et chanfrein	A2	A4
	DIN 553 ISO 7434	Gewindestifte mit Schlitz und Spitze Slotted set screws with cone point Vis sans tête avec fente et pointe	A2	A4
	DIN 557	Vierkantmuttern Square nuts Ecrous carrés	A2 -70	A4 -80
	DIN 562	Vierkantmuttern, niedrige Form Square thin nuts Ecrous carrées bas	A2	A4
	DIN 571	Sechskant-Holzschrauben Hexagon head wood screws Vis à bois à tête hexagonale	A2	A4
	DIN 580	Ringschrauben, geschmiedet Lifting eye bolts drop forged Vis à anneau	A2	A4
	DIN 582	Ringmuttern Lifting eye nuts Ecrous à anneau	A2	A4
	DIN 603 ISO 8677	Flachrundschauben mit Vierkantansatz, Teilgewinde Mushroom head square neck bolts, partial thread Vis à tête bombée à collet carré	A2	A4
	DIN 603 ISO 8677	Flachrundschauben mit Vierkantansatz, Vollgewinde Mushroom head square neck bolts, full thread Vis à tête bombée à collet carré	A2	A4
	DIN 653	Rändelschrauben, niedrige Form Knurled thumb screws, thin type Vis moletées, type bas	A1	

	DIN / ISO Art-Nr.	Bezeichnung Description	Werkstoff Material	
	DIN 660	Halbrundnieten Round head rivets Rivets à tête ronde	A2	A4
	DIN 661	Senknieten Countersunk head rivets Rivets à tête fraisée	A2	A4
	DIN 705	Stellringe Form A, mit Gewindestiften DIN 914 Adjusting rings with set screw DIN 914 Bagues d'arrêt	A2	
	DIN 835	Stiftschrauben, Einschraubende $\approx 2d$ Studs, metal end $\approx 2d$ Goujons-partie filetée $e \approx 2d$	A2	A4
	DIN 906	Verschlusschrauben mit Innensechskant und Kegelgewinde Hexagon socket pipe plugs, conical thread according to DIN 158 Bouchons filetés à six pans creux, filetage conique à la DIN 158	A2	A4
	DIN 906	Verschlusschrauben mit Innensechskant, WITHWORTH Rohrgewinde nach DIN 3858 Hexagon socket pipe plugs, conical thread according to DIN 3858 Bouchons filetés à six pans creux, filetage conique à la DIN 3858	A2	A4
	DIN 908	Verschlusschrauben mit Bund und Innensechskant, metrisches Feingewinde nach DIN 13 Hexagon socket pipe plugs, metric fine pitch according to DIN 13 Bouchons filetés avec épaulement et six pans creux, filet fin métrique à la DIN 13	A2	A4
	DIN 908	Verschlusschrauben mit Bund und Innensechskant, metrisches Feingewinde nach DIN 228 Hexagon socket pipe plugs, metric fine pitch according to DIN 13 Bouchons filetés cylindriques à collerette et à six pans creux, à la DIN 228	A2	A4
	DIN 910	Verschlusschrauben mit Bund und Außensechskant, metrisches Feingewinde nach DIN 13 Hexagon head pipe plugs, cylindrical thread metric fine pitch according to DIN 13 Bouchons filetés cylindriques à tête hexagonale, à collerette, filet fin métrique à la DIN 13	A2	A4
	DIN 910	Verschlusschrauben mit Bund und Außensechskant, zylindrisches Gasgewinde nach DIN 228 Hexagon head pipe plugs, cylindrical thread, according to DIN 228 Bouchons filetés cylindriques à tête hexagonale, à collerette; type large à la DIN 228	A2	A4
	DIN 912 ISO 4762	Zylinderschrauben mit Innensechskant, Teilgewinde Hexagon socket head cap screws, partial thread Vis à six pans creux, tête cylindrique	A2	A4 A5



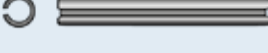





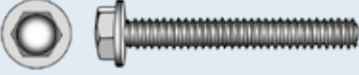

	DIN / ISO Art-Nr.	Bezeichnung Description	Werkstoff Material	
	DIN 912 ISO 4762	Zylinderschrauben mit Innensechskant, Vollgewinde Hexagon socket head cap screws, fullthread Vis à six pans creux, tête cylindrique, filetage complet	A2	A4 A5
	DIN 913 ISO 4026	Gewindestifte mit Innensechskant und Kegelkuppe Hexagon socket set screws with flat point Vis sans tête à six pans creux avec bout plat	A2	A4
	DIN 914 ISO 4027	Gewindestifte mit Innensechskant und Spitze Hexagon socket set screws with cone point Vis sans tête à six pans creux avec bout pointu	A2	A4
	DIN 915 ISO 4028	Gewindestifte mit Innensechskant und Zapfen Hexagon socket set screws with dog point Vis sans tête à six pans creux avec téton long	A2	A4
	DIN 916 ISO 4029	Gewindestifte mit Innensechskant und Ringschneide Hexagon socket set screws with cup point Vis sans tête à six pans creux avec cuvette	A2	A4
	DIN 917	Sechskant-Hutmuttern, niedrige Form Hexagon cap nuts, flat type Ecrous borgnes hexagonaux bas	A2	A4
	DIN 917	Sechskant-Hutmuttern, niedrige Form mit Feingewinde Hexagon cap nuts, flat type, fine thread Ecrous borgnes hexagonaux bas	A2	
	DIN 920	Flachkopfschrauben mit Schlitz und kleinem Kopf Slotted pan head screws with small head with fine pitch Vis à tête cylindrique à dépouille, fendue, réduite	A2	
	DIN 921	Flachkopfschrauben mit Schlitz und großem Kopf Slotted pan head screws with large head Vis à tête cylindrique à dépouille, fendue, large	A1	
	DIN 923	Flachkopfschrauben mit Schlitz und Ansatz Slotted pan head screws with shoulder Vis à tête cylindrique à dépouille, fendue, à tige ajustable	A1	
	DIN 928	Vierkant-Schweißmuttern Square weld nuts Ecrous carrés à souder	A2	A4
	DIN 929	Sechskant-Schweißmuttern Hexagon weld nuts Ecrous hexagonaux à souder	A2	A4
	DIN 931 ISO 4014	Sechskantschrauben mit Schaft, Teilgewinde Hexagon head screws with partial thread Vis à tête six pans	A2	A4

	DIN / ISO Art-Nr.	Bezeichnung Description	Werkstoff Material	
	DIN 933 ISO 4017	Sechskantschrauben mit Vollgewinde Hexagon head screws with fullthread Vis à tête six pans	A2	A4 A5
	DIN 933 SZ ISO 4017 SZ	Sechskantschrauben mit Vollgewinde und Schlitz Slotted hexagon head screws Vis à tête pans avec fente	A2	A4
	DIN 934 ISO 4032	Sechskantmuttern Hexagon nuts Ecrous hexagonaux	A2	A4 A5
	DIN 934 ISO 4032	Sechskantmuttern mit Linksgewinde Hexagon nuts left hand thread Ecrous hexagonaux à gauche	A2	A4
	DIN 934 ISO 8673	Sechskantmuttern mit Feingewinde Hexagon nuts, fine pitch, fine thread Ecrous hexagonaux, filet fin métrique	A2	A4
	DIN 935 ISO 7035	Kronenmuttern Hexagon castle nuts, slotted Ecrous hexagonaux à créneaux	A2	A4
	DIN 936	Sechskantmuttern, niedrige Form Hexagon thin nuts Ecrous hexagonaux, bas	A2	A4
	DIN 936	Sechskantmuttern, niedrige Form, Feingewinde Hexagon thin nuts, flat type, fine thread Ecrous hexagonaux, bas, filet fin métrique	A2	
	DIN 937 ISO 7038	Kronenmuttern, niedrige Form Thin hexagon castle nuts, slotted Ecrous hexagonaux à créneaux, bas	A2	A4
	DIN 938	Stiftschrauben, Einschraubende $\approx 1d$ Studs, metal end $\approx 1d$ Goujons filetés, partie filetée $\approx 1d$	A2	A4
	DIN 939	Stiftschrauben, Einschraubende $\sim 1,25d$ Studs, metal end $\sim 1,25d$ Goujons filetés, partie filetée $\sim 1,25d$	A2	A4
	DIN 961	Sechskantschrauben mit Feingewinde Hexagon head screws with fine pitch thread Vis à six pans avec filetage fin	A2	
	DIN 963 ISO 2009	Senkschrauben mit Schlitz Slotted countersunk head screws Vis à tête fraisée fendue	A2	A4

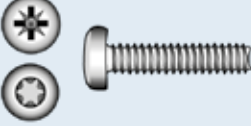
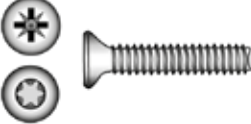









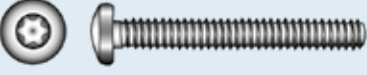

	DIN / ISO Art-Nr.	Bezeichnung Description	Werkstoff Material	
	DIN 964 ISO 2010	Linsensensschrauben mit Schlitz Slotted raised countersunk head screws Vis à tête fraisée bombée fendue	A2	A4
	DIN 965 ISO 7046	Senkschrauben mit Kreuzschlitz PH, PZ Cross recessed countersunk (flat) head screws - PH, PZ Vis à tête fraisée à empreinte cruciforme - PH, PZ	A2	A4
	ISO 14581	Senkschrauben mit Innensechsrund, TX-Antrieb Countersunk (flat) head screws, TX-Drive Vis à tête conique, fraisée, TX	A2	A4
	DIN 966 ISO 7047	Linsen-Senkschrauben mit Kreuzschlitz PH, PZ Cross recessed raised countersunk head screws - PH, PZ Vis à tête fraisée bombée à empreinte cruciforme - PH, PZ	A2	A4
	ISO 14584	Linsen-Senkschrauben, TX-Antrieb Cross recessed raised countersunk head screws, TX-Drive Vis à tête fraisée bombée à empreinte cruciforme, TX	A2	A4
	DIN 976	Gewindebolzen Threaded rods Tiges filetées	A2	A4
	DIN 976	Gewindebolzen mit Linksgewinde Threaded rods left hand thread Tiges filetées à gauche	A2	A4
	DIN 979	Kronenmuttern, niedrige Form Hexagon slotted thin castle nuts Ecrous hexagonaux à créneaux, bas	A2	A4
	DIN 982 ISO 7040	Sechskantmuttern, selbstsichernd, mit nicht-metallischem Klemmteil, hohe Form Prevailing torque type hexagon nuts with non-metallic insert, type high Ecrous auto-freiné hexagonaux avec insert non-metallique, type haut	A2	A4
	DIN 985 ISO 10511	Sechskantmuttern, selbstsichernd, mit nicht-metallischem Klemmteil, niedrige Form Prevailing torque type hexagon domed cap nuts with nonmetallic insert, type low Ecrous auto-freiné hexagonaux borgnes à callottes avec insert non-metallique	A2	A4
	DIN 986	Sechskant-Hutmuttern, selbstsichernd, mit nicht-metallischem Klemmteil Prevailing torque type hexagon domed cap nuts with nonmetallic insert Ecrous auto-freiné hexagonaux borgnes à callottes avec insert non-metallique	A2	
	DIN 988	Passscheiben Shim rings Rondelles d'ajustage	A2	

	DIN / ISO Art-Nr.	Bezeichnung Description	Werkstoff Material	
	DIN 1052	Scheiben für Holzverbindungen Washers for wood constructions Rondelles pour constructions en bois	A2	A4
	DIN 1440 ISO 8738	Scheiben für Bolzen, mittlere Ausführung Washers for clevis pins, medium Rondelles plates pour tourillons, moyen modèle	A2	A4
	DIN 1441	Scheiben für Bolzen, grobe Ausführung Washers for clevis pins, coarse Rondelles plates pour tourillons	A2	A4
	DIN 1471 ISO 8744	Kegelkerbstifte Grooved pins; full-length taper grooved Goupilles coniques cannelées	A1	
	DIN 1472 ISO 8745	Passkerbstifte Grooved pin; half-length taper grooved Goupilles cannelées d'ajustable	A1	
	DIN 1473 ISO 8740	Zylinderkerbstifte mit Fase Grooved pin; full-length parallel grooved with chamfer Goupilles cannelées calindriques avec chanfrein	A1	
	DIN 1474 ISO 8741	Steckerbstifte Grooved pin; half-length reserve taper grooved Goupilles cannelées d'ajustage	A1	
	DIN 1476 ISO 8746	Halbrundkerbnägel Grooved pin with round head Clous cannelées à tête demi-ronde	A2	
	ISO 8750	Spiral-Spannstifte Spiral pins Goupilles élastiques en spirale	A2	
	ISO 8752	Spannstifte (geschlitzt), schwere Ausführung Slotted spring pins, heavy duty Goupilles cà ressort	A2	
	DIN 1587	Sechskant-Hutmuttern, hohe Form Hexagon domed cap nuts, high type Erous borgnes à calotte hexagonaux, forme haute	A2	A4
	DIN 2093	Tellerfedern Disc spring Rondelles-ressort	A1	
	DIN 3017	Schlauchschellen mit Schneckenantrieb, Form A Hose clamps Colliers de serrage	A2	A4





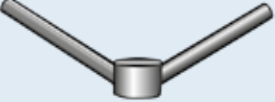



	DIN / ISO Art-Nr.	Bezeichnung Description	Werkstoff Material
	DIN 3570	Rundstahlbügel Form A, ohne Muttern und Scheiben Round steel hanger type A without nuts and washers Étrier rond, forme 1, sans écrous ni rondelles	A4
	DIN 5401	Sicherheitskugeln Security balls Obturateur bille de sécurité	A2
	DIN 6319	Kugelscheiben Form C Spherical washers, type C Rondelle à portée sphérique, type C	A2
	DIN 6319	Kugelscheiben Form D Conical seats, type D Rondelle à portée sphérique, type D	A2
	DIN 6330	Sechskantmuttern, 1,5d hoch, Form B Hexagon nuts, height = 1.5d, type B Écrous hexagonaux, hauteur = 1,5d, type B	A2 A4
	DIN 6331	Sechskantmuttern, 1,5d hoch, mit Bund Hexagon nuts 1.5d high, with collar Écrous hexagonaux 1,5d à embase cylindrique avec douille de guidage	A2 A4
	DIN 6334	Sechskantmuttern (Langmuttern), Höhe = 3d Hexagon nuts, height = 3d Écrous hexagonaux, hauteur = 3d	A2 A4 A5
	DIN 6796	Spannscheiben für Schraubenverbindungen Conical spring washers for bolted connections Rondelles élastique en cuvette pour assemblages vissés	A2 A4
	DIN 6797	Zahnscheiben Form A und J Toothed lock washers, type A and J Rondelles élastiques à dents espacées, type A et J	A2
	DIN 6798	Fächerscheiben Form A und J Serrated lock washers Rondelles élastique à dents chevanchantes	A2 A4 A5
	DIN 6798	Fächerscheiben Form V Serrated countersunk lock washers, type V Rondelles élastique à dents chevanchantes, type V	A2
	DIN 6799	Sicherungsscheiben (Haltescheiben) für Wellen Retaining washers for shafts Bagues de frein pour arbres	Spezial material
	DIN 6885	Passfedern, hohe Form, Form A Parallel keys, high type, type A Clavettes ajustées, type A	A5









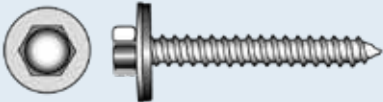

	DIN / ISO Art-Nr.	Bezeichnung Description	Werkstoff Material
	DIN 6912	Zylinderschrauben mit Innensechskant, niedriger Kopf, mit Schlüsselführung Socket head cap screws, low head, pilot recess Vis à tête cylindrique à six pans creux avec tête basse et trou de guidage	A2 A4
	DIN 6921 EN 1665	Sechskantschrauben mit Flansch und Vollgewinde Hexagon head screws with flange Vis métaux tête hexagonale à embase lisse et filetage complet	A2 A4
	DIN 6923 EN 1661	Sechskantmuttern mit Flansch mit und ohne Sperrverzahnung Hexagon flange nuts with and without serration Ecrou hexagonal à embase crantée avec et sans denture de blocage	A2 A4
	DIN 6926	Flanschmuttern selbstsichernd mit und ohne Sperrverzahnung Hexagon flange nuts with and without serration Ecrou Nylstop à embase crantée avec et sans denture de blocage	A2 A4
	DIN 7349	Scheiben für Schrauben mit schweren Spannhülsen Washers for bolts with heavy spring pins Rondelles pour vis avec goupilles élastique lourdes	A2 A4
	DIN 7500 C	Gewindefurchende Linsenschrauben Form CE, Kopf nach DIN 7985, Kreuzschlitz PZ, TX Thread rolling raised cheese head screws - PZ, TX, type CE Vis format le filetage à tête cylindrique bombée, empreinte cruciforme -PZ, TX, type CE	A2
	DIN 7500 M	Gewindefurchende Senkschrauben, Form ME, Kopf nach DIN 965, Kreuzschlitz PZ Thread rolling countersunk head screws to DIN 965 - PZ, type M Vis formant le filetage à tête fraisée, empreinte cruciforme à la DIN 965 - PZ, type ME	A2
	DIN 7504 M	Bohrschrauben mit Linsenkopf, Form M, für Weichmetalle (z.B. Aluminium), Kreuzschlitz PH, PZ, TX Self drilling screws with pan head - PH, PZ, TX, type M Vis auto-percantes, tête cylindrique bombée - PH, PZ, TX, type M	A2 A4 C1
	DIN 7504 O	Bohrschrauben mit Senkkopf, Form O, für Weichmetalle (z.B. Aluminium), Kreuzschlitz PH, PZ, TX Self drilling screws with countersunk head -PH, PZ, TX, type O Vis auto-percantes, tête fraisée - PH, PZ, TX, type O	A2 A4 C1
	DIN 7504 K	Bohrschrauben mit Sechskantkopf und Bund, Form K, für Weichmetalle (z.B. Aluminium) Self drilling screws with hexagon head and flange, type K Vis auto-percantes, tête hexagonale, type K	A4
	DIN 7504 K0	Bohrschrauben mit Sechskantkopf und Bund, Form K, für Weichmetalle (z.B. Aluminium) mit aufgesteckter A2 / EPDM- Dichtscheibe Ø 16 mm Self drilling screws with hexagon head and flange with assembled sealing washers 16mm, type K Vis autopercantes, tête hexagonale avec rondelles, type K	A2
	DIN 7967	Sicherungsmuttern Self locking counter nuts Ecrous de sécurité	A2 A4

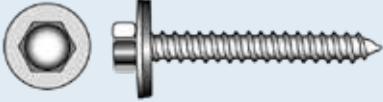



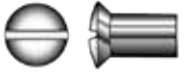

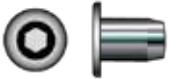
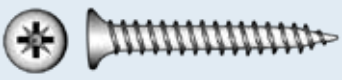

	DIN / ISO Art-Nr.	Bezeichnung Description	Werkstoff Material	
	DIN 7971 ISO 1481	Zylinder-Blechschauben mit Schlitz, Form C mit Spitze Slotted pan head tapping screws, type C Vis à tête cylindrique large, fendue, type C	A2	
	DIN 7972 ISO 1482	Senk-Blechschauben mit Schlitz, Form C mit Spitze Slotted countersunk head tapping screws, type C Vis à tôle à tête fraisée, fendue, type C	A2	
	DIN 7973 ISO 1483	Linsensenk-Blechschauben mit Schlitz, Form C mit Spitze Slotted raised countersunk head tapping screws, type C Vis à tôle à tête fraisée bombée, fendue, type C	A2	
	DIN 7976 ISO 1479	Sechskant-Blechschauben, Form C mit Spitze Hexagon head tapping screws, type C Vis à tôle à tête hexagonal, type C	A2	
	DIN 7980	Federringe für Zylinderschrauben Spring lock washers for screws with cylindrical heads Rondelles élastique sans becs pour vis à tête cylindrique	A1	A4
	DIN 7981 ISO 7049	Linsenkopf-Blechschauben, Form C mit Spitze, Kreuzschlitz PH oder Kreuzschlitz PZ Cross recessed pan head tapping screws - PH, PZ, type C Vis à tôle à tête cylindrique bombée large à empreinte cruciforme - PH, PZ, type C	A2	A4
	ISO 14585	Linsenkopf-Blechschauben, Form C mit Spitze, mit Innensechsrund Pan head tapping screws, TX-Drive, type C Vis tôle T.C.L., à six lobes intérieurs, TX, type C	A2	A4
	DIN 7982	Senk-Blechschauben, Form C mit Spitze, Kreuzschlitz PH oder Kreuzschlitz PZ Cross recessed countersunk head tapping screws - PH, PZ, type C Vis à tôle à tête fraisée à empreinte cruciforme, à bout pointu - PH, PZ, type C	A2	A4
	ISO 14586	Senk-Blechschauben, Form C mit Spitze, mit Innensechsrund Countersunk head tapping screws, TX-Drive, type C Vis tôle T.F., à lobes intérieurs, TX, type C	A2	A4
	DIN 7983 ISO 7049	Linsensenk-Blechschauben, Form C mit Spitze, Kreuzschlitz PH, oder Kreuzschlitz PZ Cross recessed raised countersunk head tapping screws - PH, PZ, type C Vis à tôle à tête fraisée bombée à empreinte cruciforme, à bout pointu - PH, PZ, type C	A2	A4
	ISO 14587	Linsensenk-Blechschauben, Form C mit Spitze, mit Innensechsrund Raised countersunk head tapping screws, TX-Drive, type C Vis tôle T.F.B., à six lobes intérieurs, TX, type C	A2	A4
	DIN 7984	Zylinderschrauben mit Innensechskant und niedrigem Kopf Hexagon socket head cap screws with low head Vis à tête cylindrique à six pans creux avec tête basse	A2	A4

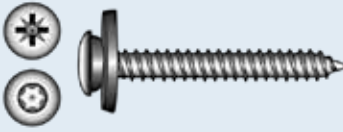
	DIN / ISO Art-Nr.	Bezeichnung Description	Werkstoff Material	
	DIN 7985 ISO 7045	Linsenschrauben, Kreuzschlitz PH, PZ Cross recessed raised cheese head screws - PH, PZ Vis à tête cylindrique bombée à empreinte cruciforme - PH, PZ	A2	A4
	ISO 14583	Linsenschrauben, Innensechsrund, TX Pan head screws, TX-Drive Vis à tête cylindrique bombée à six lobes intérieurs, TX	A2	A4
	DIN 7989	Scheiben für Stahlkonstruktionen Washers for steel constructions Rondelles pour constructions en métal	A2	A4
	ISO 10642	Senkschrauben mit Innensechskant Hexagon socket countersunk head screws Vis à tête fraisée à six pans creux	A2	A4
	DIN 7991 TX	Senkschrauben mit Innensechsrund, TX Countersunk head screws, TX-Drive Vis à tête fraisée à six lobes intérieurs, TX	A2	A4
	DIN 7995	Linsensenk-Holzschrauben, Kreuzschlitz PZ Cross recessed raised countersunk head wood screws - PZ Vis à bois à tête fraisée bombée avec empreinte cruciforme - PZ	A2 CU	
	DIN 7996	Halbrund-Holzschrauben, Kreuzschlitz PZ Cross recessed round head wood screws - PZ Vis à bois à tête ronde avec empreinte cruciforme - PZ	A2	
	DIN 7997	Senk-Holzschrauben, Kreuzschlitz PZ Cross recessed countersunk head wood screws - PZ Vis à bois à tête fraisée bombée avec empreinte cruciforme - PZ	A2	
	DIN 9021 ISO 7093	Unterlegscheiben, Außendurchmesser ≈ 3 x Schraubendurchmesse Washers with outside diameter ≈ 3 x nominal thread diameter Rondelles, diamètre extérieur ≈ 3 x diamètre nominal de filetage	A2	A4
	DIN 11024	Federstecker, doppelte Ausführung Cotter pins Goupilles ressort double		A4
	ISO 13918	Gewindebolzen Form PT Welding bolts, type PT Goujon à souder avec filetage extérieur, type PT	A2	
	DIN 80701	Knebelmuttern Toggle nuts Ecrous papillon		A4
	DIN 80704	Korbmuttern Bow nuts Anneau pour sangle		A4

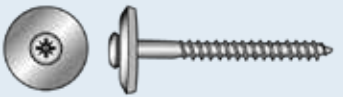
	DIN / ISO Art-Nr.	Bezeichnung Description	Werkstoff Material	
	Art.-Nr. 572	Sechskant-Holzschrauben mit Flansch Hexagon wood screws with flange Vis bois T.H. à embase	A2	
	Art.-Nr. 980	Sechskantmuttern, selbstsichernd mit Klemmteil, Ganzmetallmuttern verformt aus DIN 934 Prevailing torque type hexagon nuts, all-metal nuts Ecrous auto-freinéés hexagonaux, écrous tout métal	A2	A4
	Art.-Nr. 9044	SP-Drill Seko-Holzbauschrauben mit Bohrspitze, Innensechsrund, Fräsrippen, verstärkter Kopf, gleit beschichtet Countersunk head chipboard screws, six lobe Drive and drilling-point, double head, waxed ribs under the head Vis auto-perçantes pour agglomérés avec tête fraisée, à six lobes intérieurs	A2	
	Art.-Nr. 9045	Rundkopf-Spanplattenschrauben, mit verstärktem Kopf, gleitbeschichtet, Innensechsrund TX Pan head chipboard screws, TX-Drive Vis pour agglomérés avec tête cylindrique, à six lobes intérieurs, TX	A2	A4
	Art.-Nr. 9045	Rundkopf-Spanplattenschrauben, mit verstärktem Kopf, gleitbeschichtet, Innensechsrund TX Pan head chipboard screws, TX-Drive Vis pour agglomérés avec tête cylindrique, à six lobes intérieurs, TX	A2	A4
	Art.-Nr. 9046	Linsensenkopf-Spanplattenschrauben, gleitbeschichtet, Innensechsrund TX Raised countersunk head chipboard screws, TX-Drive Vis pour agglomérés avec tête fraisée bombée à six lobes intérieurs, TX	A2	A4
	Art.-Nr. 9046	Linsensenkopf-Spanplattenschrauben, gleitbeschichtet, Innensechsrund TX Raised countersunk head chipboard screws, TX-Drive Vis pour agglomérés avec tête fraisée bombée à six lobes intérieurs, TX	A2	A4
	Art.-Nr. 9047	Senkkopf-Spanplattenschrauben, gleitbeschichtet, Innensechsrund TX Countersunk head chipboard screws, TX-Drive Vis pour agglomérés avec tête fraisée, à six lobes intérieurs, TX	A2	A4
	Art.-Nr. 9047	Senkkopf-Spanplattenschrauben, gleitbeschichtet, Innensechsrund TX Countersunk head chipboard screws, TX-Drive Vis pour agglomérés avec tête fraisée, à six lobes intérieurs, TX	A2	A4
	Art.-Nr. 9048	Rundkopf-Spanplattenschrauben, gleitbeschichtet, A2 Kreuzschlitz PZ Coss recessed pan head chipboard screws - PZ Vis pour agglomérés avec tête cylindrique - PZ	A2	
	Art.-Nr. 9048	Rundkopf-Spanplattenschrauben, gleitbeschichtet, A2 Kreuzschlitz PZ Coss recessed pan head chipboard screws - PZ Vis pour agglomérés avec tête cylindrique - PZ	A2	

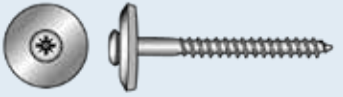







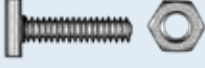

	DIN / ISO Art-Nr.	Bezeichnung Description	Werkstoff Material	
	Art.-Nr. 9049	Linsensenkopf-Spanplattenschrauben, gleitbeschichtet, Kreuzschlitz PZ Cross recessed raised chipboard screws - PZ Vis pour agglomérés avec tête fraisée bombée - PZ	A2	
	Art.-Nr. 9049	Linsensenkopf-Spanplattenschrauben, gleitbeschichtet, Kreuzschlitz PZ Cross recessed raised chipboard screws - PZ Vis pour agglomérés avec tête fraisée bombée - PZ	A2	
	Art.-Nr. 9050	Senkkopf-Spanplattenschrauben, gleitbeschichtet, Kreuzschlitz PZ Cross recessed countersunk chipboard screws - PZ Vis pour agglomérés avec tête fraisée - PZ	A2	A4
	Art.-Nr. 9050	Senkkopf-Spanplattenschrauben, gleitbeschichtet, Kreuzschlitz PZ Cross recessed countersunk chipboard screws - PZ Vis pour agglomérés avec tête fraisée - PZ	A2	A4
	Art.-Nr. 9051	Blechschauben mit Innensechskant-Zylinderkopf Kopf nach DIN 912 Tapping screws with head DIN 912 Vis à tôle avec tête cylindrique DIN 912	A2	A4
	ISO 15983	Blindnieten mit Flachkopf und gerilltem Nietdorn, ehemals DIN 7337 Blind rivets, with break mandrel Rivets aveugles avec mandrin à rivet cannelé	A2	
	ISO 7380-1	Linsenkopfschrauben mit Innensechskant Button head screws Vis à tête bombée à six pans creux	A2	A4
	ISO 7380-2	Linsenkopfschrauben mit Innensechskant und Flansch Flange button head socket screws Vis à creux, tête bombée à embase	A2	A4
	Art.-Nr. 9054	Karoscheiben Penny washers Rondelles de carrosserie	A2	A4
	Art.-Nr. 9055	Dichtscheiben gewölbt für Senkschrauben, mit EPDM-Beschichtung Sealing washers for countersunk screws with EPDM coating Rondelles d'étanchéité avec EPDM revêtement	A2	
	Art.-Nr. 9055	Dichtscheiben für Senkschrauben und Sechskantschrauben mit EPDM-Beschichtung, Kupfer Sealing washers with EPDM coating, for countersunk screws, copper Rondelles d'étanchéité	CU	
	NF E 27128	Flachrundschauben NF E 27-128 Slotted mushroom head screws Vis à tête bombée, fendue	A2	
	Art.-Nr. 9057	Fassadenbauschrauben A (mit Spitze) mit aufgezogener U-Scheibe aus Edelstahl und auf vulkanisierter EPDM-Dichtung Self-sealing cladding screws Vis de façades	A2	
	Art.-Nr. 9057	Fassadenbauschrauben BZ (mit Zapfen) mit aufgezogener U-Scheibe aus Edelstahl und auf vulkanisierter EPDM-Dichtung Self-sealing cladding screws Vis de façades (à téton) avec rondelle et revêtement vulcanisé	A2	

	DIN / ISO Art-Nr.	Bezeichnung Description	Werkstoff Material	
	Art.-Nr. 9058	Gewindeeinssätze, selbstschneidend Selftapping inserts Douilles filetéés, auto-taroudage	A1	
	Art.-Nr. 9059	Fassadenbauschrauben A (mit Spitze) mit aufgezogener U-Scheibe aus Edelstahl und aufvulkanisierter EPDM-Dichtung 19 mm Self-sealing cladding screws Vis de façades (à pointe) avec rondelle et revêtement vulcanisé EPDM 19mm	A2	
	Art.-Nr. 9059	Fassadenbauschrauben BZ (mit Zapfen) mit aufgezogener U-Scheibe aus Edelstahl und aufvulkanisierter EPDM-Dichtung 19 mm Self-sealing cladding screws Vis de façades (à tétou) avec rondelle et revêtement vulcanisé EPDM 19mm	A2	
	Art.-Nr. 9098	Fassadenbauschrauben A (mit Spitze) Dichtscheibe 22 mm Cladding screws point sealing washer 22 mm Vis pour façade (à pointe) avec rondelle et revêtement vulcanisé EPDM 22 mm	A2	
	Art.-Nr. 9098	Fassadenbauschrauben BZ (mit Zapfen) Dichtscheibe 22 mm Cladding screws cone point sealing washer 22 mm Vis pour façade (à tétou) avec rondelle et revêtement vulcanisé EPDM 22 mm	A2	
	Art.-Nr. 9060	Anschweissmuttern, Ausführung A, 2 Schweissbuckel-Richtung unten oder oben Weld-on nuts - A Ecrus souder entièrement filetés - A, 2 saillies de soudage en bas pou en haut	A2	
	Art.-Nr. 9060	Anschweissmuttern, Ausführung B, 4 Schweissbuckel-Richtung unten oder oben Weld-on nuts - B Ecrus souder entièrement filetés - B, 2 saillies de soudage en bas pou en haut	A2	
	Art.-Nr. 9060	Anschweissmuttern, Ausführung C, ohne Schweissbuckel Weld-on nuts - C Ecrus souder entièrement filetés - C, sans saillies de soudage	A2	
	Art.-Nr. 9061	Hülsenmuttern mit Linsensenkkopf und Schlitz Slotted raised countersunk head sleeve nuts Écrus douille à tête fraisée bombée fendus	A1	A4
	Art.-Nr. 9062	Hülsenmuttern mit Senkkopf und Innensechskant Hexagon socket countersunk head sleeve nuts Écrus douille avec tête fraisée et six pans creux	A1	A4
	Art.-Nr. 9262	Hülsenmuttern mit Flachkopf und Innensechskant Hexagon socket flat head sleeve nuts Écrus douille à tête plate et avec six pand creux	A1	A4
	Art.-Nr. 9063	Scharnierbandschrauben, Kopf Ø 5,0mm, Kreuzschlitz PZ Hinge tape chipboard screws, head 5,0mm, PZ Vis Agglo. T.F pour charnières, tête 5,0mm, PZ	A2	A4
	Art.-Nr. 9064	Sechskant-Einpressmuttern Insert-press nuts Ecrus à sertir, six pans creux	A2	

	DIN / ISO Art-Nr.	Bezeichnung Description	Werkstoff Material	
	Art.-Nr. 9065	Blechschauben mit Kappenkopf, ähnlich DIN 7981, Kreuzschlitz PH, TX Self tapping screws with caphead, similar to DIN 7981, PH, TX Vis à tôle avec tête de calotte, comparable à DIN 7981, PH, TX	A2	
	Art.-Nr. 9066	Fensterbankschrauben mit Blechschaubengewinde fertig montiert mit Polyamid-Unterlegscheiben, Kappenkopf ähnl. DIN 7981, Kreuzschlitz PZ - oder TX, Polyamidscheibe in folgenden Farben erhältlich: natur, weiß, braun, RAL 7016, Special screws for window boards mounted with polyamid washers, self tapping thread - PZ, TX Vis spéciales pour fenêtres montée avec rondelle polyamid - capuchon comparable à DIN 7981, empreinte cruciforme PZ, TX	A2	
	Art.-Nr. 9066	Fensterbankschrauben mit Grob-Gewinde fertig montiert mit Polyamid- Unterlegscheiben, Kappenkopf ähnl. DIN 7981, Kreuzschlitz PZ oder TX, Polyamidscheibe in folgenden Farben erhältlich: natur, weiß, braun, RAL 7016, Special screws for window boards mounted with polyamid washers, self tapping thread - PZ, TX Vis spéciales pour fenêtres montée avec rondelle polyamid en version: filetage vis tôle -PZ, TX	A2	
	Art.-Nr. 9067	Spenglerschrauben 15mm / (DIN 7995 Z mit aufvulkanisierter EPDM Dichtscheibe, fertig montiert) Cross recessed raised countersunk head wood screws (DIN 7995 Z) + sealing washers Vis bois (DIN 7995 Z) avec rondelle EPDM vulcanisé	A2	CU
	Art.-Nr. 9068	Spenglerschrauben 20mm / (DIN 7995 Z mit aufvulkanisierter EPDM Dichtscheibe, fertig montiert) Cross recessed raised countersunk head wood screws (DIN 7995 Z) + sealing washers Vis bois (DIN 7995 Z) avec rondelle EPDM vulcanisé	A2	CU
	Art.-Nr. 9069	Spenglerschrauben 25mm / (DIN 7995 Z mit aufvulkanisierter EPDM Dichtscheibe, fertig montiert) Cross recessed raised countersunk head wood screws (DIN 7995 Z) + sealing washers Vis bois (DIN 7995 Z) avec rondelle EPDM vulcanisé	A2	CU
	Art.-Nr. 9070	Gewinderundmuffen mit durchgehendem Innengewinde Round coupler nuts Ecrous rondes de jonction avec filetage femelle	A2	A4
	Art.-Nr. 9071	Gewindegewindesechskantmuffen mit durchgehendem Innengewinde Hexagon coupler nuts Ecrous hexagonaux de jonction avec filetage femelle	A2	A4
	NF E 27 619	Rosetten, Vollmetall NF E 27-619 Rosettes, turned full body, 90° Rondelles cuvettes usince	A2	A4







	DIN / ISO Art-Nr.	Bezeichnung Description	Werkstoff Material
	Art.-Nr. 9082	Stockschrauben mit Holz- und ISO-Gewinde Dowel screws with wood and ISO thread Vis sans tête avec filetage à bois et métaux (ISO)	A2
	Art.-Nr. 9083	Türbandschrauben, Rundkopf, Innensechsrund TX Hinge-strip screws, TX Vis de peinture, tête ronde, TX	A2
	Art.-Nr. 9085	Kombimuttern mit beweglicher Scheibe Nut-and-washer assembly Ecrous sertis sur rondelle	A2
	Art.-Nr. 9086	Flachrundkopf-Holzschrauben "Trespo" mit Innensechsrund TX 20 in folgenden Farben erhältlich: RAL 1013, RAL 5002, RAL 6009, RAL 7012, RAL 7016, RAL 7037, RAL 7038, RAL 8014, RAL 9001, RAL 9005, RAL 9010 Thrushead screws for wood constructions - TX 20 Vis de façades - TX 20	A2
	Art.-Nr. 9087	Spenglerschrauben 15mm / 2tlg., (DIN 7995 TX mit aufvulkanisierter EPDM Dichtscheibe, fertig montiert), Innensechsrund TX In folgenden Farben erhältlich: RAL 3009, RAL 7016, RAL 8004, RAL 9010 Raised countersunk head wood screws (DIN 7995 TX) + sealing washers, TX-Drive Vis bois (DIN 7995 TX) avec rondelle EPDM vulcanisé, TX	A2 A2/CU
	Art.-Nr. 9087	Spenglerschrauben 15mm / 3tlg., (DIN 7995 TX mit aufvulkanisierter EPDM Dichtscheibe, fertig montiert), Innensechsrund TX In folgenden Farben erhältlich: RAL 3009 Oxidrot, RAL 7016 Anthrazit- grau, RAL 8004 Kupferbraun, RAL 9010 Reinweiß, Raised countersunk head wood screws (DIN 7995 TX) + sealing washers, TX-Drive Vis bois (DIN 7995 TX) avec rondelle EPDM vulcanisé, TX	A2 A2/CU
	Art.-Nr. 9088	Spenglerschrauben 20mm / 2tlg., (DIN 7995 TX mit aufvulkanisierter EPDM Dichtscheibe, fertig montiert), Innensechsrund TX Raised countersunk head wood screws (DIN 7995 TX) + sealing washers, TX-Drive Vis bois (DIN 7995 TX) avec rondelle EPDM vulcanisé, TX	A2 A2/CU
	Art.-Nr. 9088	Spenglerschrauben 20mm / 3tlg., (DIN 7995 TX mit aufvulkanisierter EPDM Dichtscheibe, fertig montiert), Innensechsrund TX Raised countersunk head wood screws (DIN 7995 TX) + sealing washers, TX-Drive Vis bois (DIN 7995 TX) avec rondelle EPDM vulcanisé, TX	A2 A2/CU
	Art.-Nr. 9089	Spenglerschrauben 25mm / 2tlg., (DIN 7995 TX mit aufvulkanisierter EPDM Dichtscheibe, fertig montiert), Innensechsrund TX Raised countersunk head wood screws (DIN 7995 TX) + sealing washers, TX-Drive Vis bois (DIN 7995 TX) avec rondelles EPDM vulcanisé, TX	A2 A2/CU

	DIN / ISO Art-Nr.	Bezeichnung Description	Werkstoff Material
	Art.-Nr. 9089	Spenglerschrauben 25mm / 3tlg., (DIN 7995 TX mit aufvulkanisierter EPDM Dichtscheibe, fertig montiert), Innensechsrund TX Raised countersunk head wood screws (DIN 7995 TX) + sealing washers, TX-Drive Vis bois (DIN 7995 TX) avec rondelle EPDM vulcanisé, TX	A2 A2/CU
	Art.-Nr. 9287	Spenglerschrauben 15mm / 2tlg., (DIN 7995 TX mit aufvulkanisierter EPDM Dichtscheibe, fertig montiert), Innensechsrund TX Raised countersunk head wood screws (DIN 7995 TX) + sealing washers, TX-Drive Vis bois (DIN 7995 TX) avec rondelle EPDM vulcanisé, TX	A2 A2/CU
	Art.-Nr. 9288	Spenglerschrauben 20mm / 2tlg., (DIN 7995 TX mit aufvulkanisierter EPDM Dichtscheibe, fertig montiert), Innensechsrund mit oder ohne Bohrspitze Raised countersunk head wood screws (DIN 7995 TX) + sealing washers, TX-Drive Vis bois (DIN 7995 TX) avec rondelle EPDM vulcanisé, TX	A2 A2/CU
	Art.-Nr. 9387	Spenglerschrauben 15mm / 2tlg., (DIN 7995 TX mit aufvulkanisierter EPDM Dichtscheibe, fertig montiert), Innensechsrund mit oder ohne Bohrspitze Raised countersunk head wood screws (DIN 7995 TX) + sealing washers, TX-Drive Vis bois (DIN 7995 TX) avec rondelle EPDM vulcanisé, TX	A2 A2/CU
	Art.-Nr. 9388	Spenglerschrauben 15mm / 2tlg., (DIN 7995 TX mit aufvulkanisierter EPDM Dichtscheibe, fertig montiert), Innensechsrund mit Bohrspitze Raised countersunk head wood screws (DIN 7995 TX) + sealing washers, TX-Drive Vis bois (DIN 7995 TX) avec rondelle EPDM vulcanisé, TX	A2 A2/CU
	Art.-Nr. 9090	Schrauben für Thermoplaste (TP) mit Senkkopf, Kreuzschlitz PH TP screws, countersunk head, cross recessed - PH Vis - TP - à tête fraisée avec empreinte cruciforme - PH	A2
	Art.-Nr. 9091	Schrauben für Thermoplaste (TP) mit Linsenkopf, Kreuzschlitz PH TP screws, pan head, cross recessed - PH Vis - TP - à tête bombée avec empreinte cruciforme - PH	A2
	Art.-Nr. 9092	Fassadenschrauben, HI-LO Gewinde und Zentrierspitze, Kreuzschlitz PH Cladding screws, HI-LO thread and center point - PH Vis de bardage filetage partiel, pointe de centrage - PH	A2
	Art.-Nr. 9093	Schnorr-Sicherungsscheiben "S" Schnorr safety-washers type "S" Rondelles de sécurité "S"	A2
	Art.-Nr. 9094	Hakenkopfschrauben Typ 50/30 mit Sechskantmutter nach DIN 934 Hammer head screws for special purposes Vis à tête rectangulaire	A4

	DIN / ISO Art.-Nr.	Bezeichnung Description	Werkstoff Material	
	Art.-Nr. 9095	Hakenkopfschrauben Typ 40/22 mit Sechskantmutter nach DIN 934 Hammer head screws for special purposes Vis à tête rectangulaire		A4 A5
	Art.-Nr. 9096	Hammerkopfschrauben Typ 38/17 mit Sechskantmutter nach DIN 934 Hammer head screws for special purposes Vis de tête marteau	A2	A4
	Art.-Nr. 9097	Hammerkopfschrauben Typ 28/15 mit Sechskantmutter nach DIN 934 Hammer head screws for special purposes Vis de tête marteau	A2	A4
	Art.-Nr. 9019	Hammerkopfschrauben Typ 41/41 mit Teilverzahnung Hammer head bolts type 41/41 with partial serration Vis de tête marteau , type 41/41 avec denture partielle	A2	
	NF E 25 511	AFNOR-Kontaktscheiben, Form M AFNOR contact washers, type M Rondelles de serrage AFNOR, type M	A2	
	NF E 25 514	AFNOR-Scheiben, Form: L, LL, M, Z AFNOR washers, type: L, LL, M, Z Rondelles AFNOR, type: L, LL, M, Z	A2	A4
	Art.-Nr. 9100	Zylinderkopf-Sicherheitsblechschrauben, mit ZWEILOCH-ANTRIEB, Linsenkopf Panhead Security screws TWO-HOLE-Drive Vis métaux TC-2 trous	A2	
	Art.-Nr. 9101	Zylinderkopf-Sicherheitsblechschrauben mit ZWEILOCH- ANTRIEB, Linsenkopf Panhead Security screws TWO-HOLE-Drive Vis métaux TC-2 trous	A2	
	Art.-Nr. 9102	Senkkopf-Sicherheitsblechschrauben mit ZWEILOCH- ANTRIEB Security screws TWO-HOLE-Drive Vis métaux TC-2 trous	A2	
	Art.-Nr. 9103	Senkkopf-Sicherheitsschrauben, metrisch, mit ZWEILOCH- ANTRIEB Security screws TWO-HOLE-Drive Vis métaux TC-2 trous	A2	
	Art.-Nr. 9104	Liseko-Sicherheitsblechschrauben mit ZWEILOCH-ANTRIEB Security screws TWO-HOLE-Drive Vis tôle TFB-2 trous	A2	A4
	Art.-Nr. 9105	Rundkopf-Sicherheitsblechschrauben, mit ZWEILOCH-ANTRIEB Security screws TWO-HOLE-Drive Vis tôle tête bombée - 2 trous	A2	A4

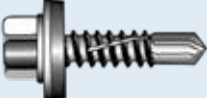
	DIN / ISO Art.-Nr.	Bezeichnung Description	Werkstoff Material
	Art.-Nr. 9110	Flachrundkopf-Sicherheitsblechschrauben mit INNENSECHSKANT und SICHERHEITS-PIN Buttonhead security screws PIN-HEXAGON Vis tôle tête bombée 6 pans creux + Téton	A2
	Art.-Nr. 9111	Flachrundkopf-Sicherheitsschrauben, metrisch (ISO 7380) mit INNENSECHSKANT und SICHERHEITS-PIN Buttonhead security screws PIN-HEXAGON Vis métaux tête bombée HC + Téton	A2
	Art.-Nr. 9112	Senkkopf-Sicherheitsblechschrauben mit INNENSECHSKANT und SICHERHEITS-PIN Security screws PIN-HEXAGON Vis tôle TF 6 pans creux + Téton	A2
	Art.-Nr. 9113	Senkkopf-Sicherheitsschrauben, metrische (ISO 7991) mit INNENSECHSKANT und SICHERHEITS-PIN Security screws PIN-HEXAGON Vis métaux TFHC + Téton	A2
	Art.-Nr. 9120	Flachrundkopf-Sicherheitsblechschrauben, metrisch, mit INNENSECHSRUND und SICHERHEITS-PIN Security screws PIN-TX Vis tôle tête bombée TX + Téton	A2
	Art.-Nr. 9121	Flachrundkopf-Sicherheitsschrauben, metrisch (ISO 7380) mit INNENSECHSRUND und SICHERHEITS-PIN Security screws PIN-TX Vis métaux tête bombée TX + Téton	A2
	Art.-Nr. 9122	Senkkopf-Sicherheitsblechschrauben mit INNENSECHSRUND und SICHERHEITS-PIN Security screws PIN-TX Vis tôle TF TX + Téton	A2
	Art.-Nr. 9123	Senkkopf-Sicherheitsschrauben, metrisch (DIN 7991) mit INNENSECHSRUND und SICHERHEITS-PIN Security screws PIN-TX Vis métaux TF TX + Téton	A2
	Art.-Nr. 9130	Halbrundkopf-Sicherheitsblechschrauben mit EINWEG-ANTRIEB Security screws ONEWAY Vis tôle TC fente SENS UNIQUE	A2
	Art.-Nr. 9131	Halbrundkopf-Sicherheitsschrauben, metrisch (DIN 7991), mit EINWEG-ANTRIEB Security screws ONEWAY Vis métaux TC fente SENS UNIQUE	A2
	Art.-Nr. 9132	Linsenkopf-Blechschrauben mit EINWEG-ANTRIEB Security screws ONEWAY Vis tôle TFB fente SENS UNIQUE	A2

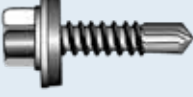
	DIN / ISO Art-Nr.	Bezeichnung Description	Werkstoff Material
	Art.-Nr. 9140	Flachrundkopf-Sicherheitschrauben ISK mit Stopfen, metrisch (ISO 7380) · Hexagon socket screws with plug Vis métaux bombée HC avec bouchon à téton blocage au marteau	A2
	Art.-Nr. 9141	Senkkopf-Sicherheitschrauben ISK mit Stopfen, metrisch (ISO 7991) Hexagon socket screws with plug Vis métaux bombée HC avec bouchon à téton blocage au marteau	A2
	Art.-Nr. 9145	Einschlagstopfen für Innensechskantantrieb Security plugs for hexagon socket Drive Obturateur pour empreinte HC	A1
	Art.-Nr. 9150	Abreissmutter Inviolable nuts Ecrous autocassants	A2
	Art.-Nr. 9155	Abreisschrauben Shear screws Vis autocassante	A2
	Art.-Nr. 1001	A4 Stabdeckschrauben, Flachsenkopf mit TX-Antrieb Marine-woodfloor-screws with TX-Drive Vis pour sol de bois	A4
	Art.-Nr. 1021	Universal-Blind-Einnietmutter, kleiner Senkkopf Blind rivet nuts, small flat head Ecrous rivet aveugle	A2
	Art.-Nr. 9156	Einschlagsterne für Innensechsrundantrieb Security stars for six lobe Drive Obturateur pour empreinte six lobes	Zinc
	Art.-Nr. 9199	Schienenmutter Typ 41/41 Teilverzahnung Rail nuts 41/41 Écrous pour rail type 41/41	A2 A4
	Art.-Nr. 9199	Schienenmutter Typ 41/41 mit Teilverzahnung und Fixierhilfe Sliding nuts type 41/41 partial serration Écrous pour rail type 41/41	A2
	Art.-Nr. 9215	Sperrkantringe ähnlich DIN 128 Serrated curved spring lock washers Rondelles élastiques ondulées comme DIN 128	A1
	Art.-Nr. 9217	Sperrkantscheiben Form M Z-type serrated conical spring washers type M Rondelles autobloquantes, type M	A2 A4
	Art.-Nr. 9219	Sperrkantscheiben Form S Z-type serrated conical spring washers type S Rondelles autobloquantes, type S	A4

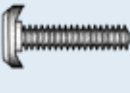
	DIN / ISO Art-Nr.	Bezeichnung Description	Werkstoff Material
	Art.-Nr. 9221	Sperrkantscheiben Form L Z-type serrated conical spring washers type L Rondelles autobloquantes, type L	A4
	Art.-Nr. 9260	Einschlagmuttern Drive-in nuts / T-Nuts Ecrous à griffes	A2
	Art.-Nr. 9297	Gewindeplatten Threaded plates Plaques filetées	A2
	Art.-Nr. 9297	Gewindeplatten scharfkantig Threaded plates Plaques filetées, coupantes	A2
	Art.-Nr. 9297	Gewindeplatten nach Zeichnung Threaded plates Plaques filetées	A2
	Art.-Nr. 9504	BI-Metall Bohrschrauben in folgenden Größen: SP-B2-2-6,0, SP-B2-2H-5,5, SP-B2-2-4,8, SP-B2-12-5,5, SP-B2-3-5,5, SP-B2-6-5,5, SP-B2-2-6,3, SP-B2-6-6,3, SP-B4-6-5,5, SP-B4-6-6,3 BI-Metal-Self drilling screws Vis bimétal autoperceuses	Bi-metal A2 Bi-metal A4
	Art.-Nr. 9505	BI-Metall Dünnschrauben mit und ohne Dichtscheibe BI-Metal thin sheet screw Vis bimétal autoperceuses avec ou sans joint	Bi-metal A2
	Art.-Nr. 9604	Sechskant-Bohrschrauben Self-drilling screw Vis autoperceuses six pans	A2
	Art.-Nr. 9510	Seko BI-Metall Flügelbohrschrauben in folgenden Größen: SP-B2-3-4,2, SP-B2-4-4,8, SP-B2-12-5,5, SP-B2-6-5,5 BI-Metal countersunk wing drilling screws Vis Bi-Metal TF avec ailettes	Bi-metall A2
	Art.-Nr. 9595	Hakenkopfschraube mit Verzahnung T-head bolts with serration Vis à tête rectangulaire avec denture	A4-50

Informationen zu Maßen und Einheiten

Information about measurements and units

Informations sur mesures et unités

12

■ Metrische Maßangaben (mm) / Metric measurements / Dimensions métriques

Maß Measure / Mesure	Bohrer für Kernloch Drill for core hole / Perceuse pour avant-trou	Schlüsselweiten (SW)		
		Sechskantschrauben Hexagon head screws Vis hexagonales	Innensechskantzylinderschrauben Hexagon socket head cap screws Vis à tête cylindrique à six pans creux	Innensechskantsenkschrauben Hexagon socket countersunk head screws Vis à six pans creux
M1	0,75	–	–	–
M2	1,6	4,0	1,5	–
M3	2,5	5,5	2,5	2,0
M4	3,3	7,0	3,0	2,5
M5	4,2	8,0	4,0 (5,0)	3,0
M6	5,0	10,0	5,0	4,0
M8	6,8	13 (12)	6,0	5,0
M10	8,5	17 (16)	8,0	6,0
M12	10,5	19 (18)	10,0	8,0
M16	14,0	24,0	14,0	10,0

■ Gewindeeinheiten Basis / Thread units / Base des unités de filetage

Zoll / inch / pouce	mm	Zoll / inch / pouce	mm	Zoll / inch / pouce	mm
2"	50,8	1/16"	1,588	1/32"	0,794
1 1/2"	38,1	3/16"	4,763	3/32"	2,381
1 1/4"	31,75	5/16"	7,938	5/32"	3,968
1"	25,4	7/16"	11,113	1/64"	0,397
1/2"	12,7	13/16"	20,638	3/64"	1,191
1/4"	6,35	15/16"	23,813		
3/4"	19,05				
1/8"	3,175				
3/8"	9,525				
5/8"	15,875				
7/8"	22,225				

Skizzen Abkürzungen / Sketch keywords / Esquisse mots-clés

L, L1, L2...	Länge	Length	Longueur
B, B1, B2...	Breite	Width	Largeur
H, H1, H2...	Höhe	Height	Hauteur
T, T1, T2...	Tiefe	Depth	Profondeur
iL, iL1, iL2...	Innere Länge	Inside length	Longueur intérieure
iB, iB1, iB2...	Innere Breite	Inside width	Largeur intérieure
iH, iH1, iH2...	Innere Höhe	Inside height	Hauteur intérieure
D, D1, D2...	Durchmesser außen	Diameter outside	Diamètre extérieure
iD, iD1, iD2...	Innendurchmesser	Diameter inside	Diamètre intérieure
ø, ø1, ø2...	Material-Durchmesser	Material diameter	Diamètre du matériau
Ø	Für Kette/Rohr/Schlauch/Seil-Ø	For chain/tube/hose/rope-Ø	Pour chaîne/tube/tuyau/corde-Ø
DS-Ø	Drahtseil-Durchmesser	Wire rope diameter	Diamètre du câble
S-Ø	Seil-Durchmesser	Rope diameter	Diamètre de corde
A, A1, A2...	Achsabstand	Center distance	Distance du centre
C, C1, C2...	Öffnungsweite	Opening width	Largeur d'ouverture
S, S1, S2...	Materialstärke	Thickness	Épaisseur
BD	Bohrloch-Durchmesser	Drilling diameter	Diamètre du trou
GW	Gewinde	Thread	Filetage
K	Klemmbereich	Clamping area	Zone de serrage
SW	Schlüsselweite	Wrench size / across flat	Largeur de clé
PH	Phillips Kreuzschlitz-Antrieb H	Cross recessed drive Phillips H	Empreinte cruciforme Phillips H
PZ	Pozi Kreuzschlitz Antrieb Z	Cross recessed drive Pozi Z	Empreinte cruciforme Pozi Z
TX	Innensechsrund/Sternantrieb	Inner multi-tooth/star drive	Denture intérieure

Meet Marinotech online!



www.marinotech.de/newsletter

-  **Der Marinotech-Newsletter!** Damit Sie in Zukunft noch gezielter informiert sind. Ihre Vorteile:
 - die besten Angebote aus unserem Shop
 - exklusive Marinotech Angebote
 - Neuheiten und Infos rund um den Markt der Edelstahl-Verbindungselemente
 - Aktuelles von Marinotech
-  **The Marinotech newsletter!** So that you will be even better informed in the future. **Your advantages:**
 - the best offers from our shop
 - exclusive Marinotech offers
 - News and information about the market for stainless steel fasteners
 - News from Marinotech
-  **La lettre d'information Marinotech!**
 - Pour que vous soyez encore mieux informés à l'avenir.
 - les meilleures offres de notre boutique
 - offres exclusives de Marinotech
 - Nouvelles et informations sur le marché des éléments de fixation en acier inoxydable
 - Nouvelles de Marinotech
-  **El boletín de Marinotech!** Para que en el futuro esté más específicamente informado. **Sus ventajas:**
 - las mejores ofertas de nuestra tienda
 - ofertas exclusivas de Marinotech
 - noticias e información sobre el mercado de las fijaciones de acero inoxidable
 - Noticias de Marinotech
-  **Biuletyn Marinotech!** Abyś w przyszłości był jeszcze bardziej konkretnie poinformowany. **Twoje zalety:**
 - najlepsze oferty z naszego sklepu
 - ekskluzywne oferty Marinotech
 - wiadomości i informacje o rynku elementów złącznych ze stali nierdzewnej
 - Wiadomości z Marinotech

Folgen Sie uns auch auf



www.marinetech.de

Lernen Sie unser Unternehmen kennen: Hintergründe, News, das Team und vieles mehr ...

- Get to know our company: Background, news, the team and much more ...
- Apprenez à connaître notre entreprise: les antécédents, les nouvelles, l'équipe et bien plus encore ...
- Conozca nuestra empresa: Información de fondo, noticias, el equipo y mucho más ...
- Poznaj naszą firmę: Informacje ogólne, wiadomości, zespół i wiele więcej ...



www.marinetech.shop

Das ganze Sortiment einfach per Mausclick bestellen.

- Simply order the entire range for point-and-click
- Commandez toute la gamme par un simple clic de souris.
- Pida todo el surtido con un simple clic del ratón.
- Zamówienie całego asortymentu po prostu przez kliknięcie myszką.



www.marinetech.de/katalog

Der Marinetech-Katalog to-go: Zum digitalen Blättern und als Downloadoption mit allen aktuellen Neuheiten und Sonderangeboten.

- The Marinetech catalog to-go: For browsing digitally and as a download option with all the latest innovations and special offers.
- Le catalogue Marinetech à emporter: pour la navigation numérique et comme option de téléchargement avec toutes les nouveautés et les offres spéciales du moment.
- El catálogo de Marinetech para llevar: Para hojearlo digitalmente y como opción de descarga, con las últimas novedades y ofertas especiales.
- Katalog Marinetech to-go: Do cyfrowego przeglądania i jako opcja do pobrania z wszystkimi najnowszymi nowościami i ofertami specjalnymi.



www.marinetech.de/downloads

Unser Download-Center mit vielen weiteren Infos zum Download

- Our download hub with a lot more information to download
- Notre centre de téléchargement avec beaucoup plus d'informations sur le téléchargement
- Nuestro centro de descargas con mucha información adicional para descargar
- Nasze centrum pobierania z wieloma dodatkowymi informacjami do pobrania

MT-Display "kompakt"

Das MT-Display "kompakt" für Ihre Verkaufsausstellung

Platz für bis zu **200 Artikel** bei platzsparenden Maßen: vier Seiten à **30 cm Breite, 1,80 m Höhe** und ein Fußdurchmesser von **50 cm**.

Sauber aufgehängt und gut präsentiert

Konfektionierte Produkt-Bliesterkarten mit Euro-Standard Lochung für einfache Handhabung und schnelle Bestückung. Alle relevanten Produktinfos auf einen Blick: EAN-Code, Artikelbeschreibung und Artikelnummer. Alle Artikel sind geblistert erhältlich – ab Stückzahl 1!



MT display "compact"

The MT display "compact" for your sale exhibition

Space for up to **200 items** with space-saving dimensions: four sides à **30 cm width, 1.80 m height** and a foot diameter of **50 cm**.

Neatly hung and well presented

Assembled product blister cards with Eurostandard perforation for easy handling and fast loading. All relevant product info at a glance: EAN code, article description and article number. All articles are available blistered - from quantity 1!





30
years



Marinotech Edelstahlhandel GmbH & Co. KG

Marschgehren 16 · 28779 Bremen
Deutschland / Germany

Tel. +49 421 - 69056 - 0
Fax +49 421 - 69056 - 50
info@marinotech.de

» www.marinotech.shop

» www.marinotech.de

Folgen Sie uns auch auf

