

Seat frames

OSCOLATI

Polyethylene seat with foldable backrest

Fitted with cushion, surface mounting or mounting on seat pedestals available in our catalogue (versions without slide).

Code	Seat AxB mm	Colour
48.405.00	500x430	White/white
48.405.01	543x466	Grey/white



Seat with foldable backrest and pull-out padding

High-quality vinyl cushions, technopolymer zip fastener.

Code	Type	Colour
48.402.01	Lined with high-quality vinyl	White RAL 9010
48.402.03	Lined with high-quality vinyl	White/Blue RAL 9002 + RAL 5013
48.402.05	Frame only, no cushions	-

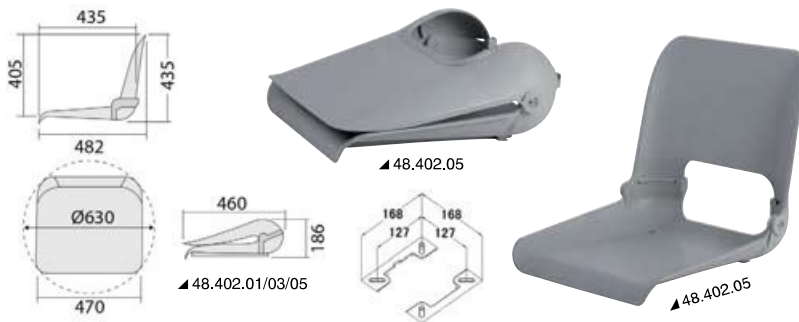

De Luxe seat with foldable backrest

High-quality vinyl cushions, aluminium zip fastener.

Code	Type	Colour
48.403.01	Lined with high-quality vinyl	White RAL 9010
48.403.03	Lined with high-quality vinyl	White/Blue RAL 9002 + RAL 5013

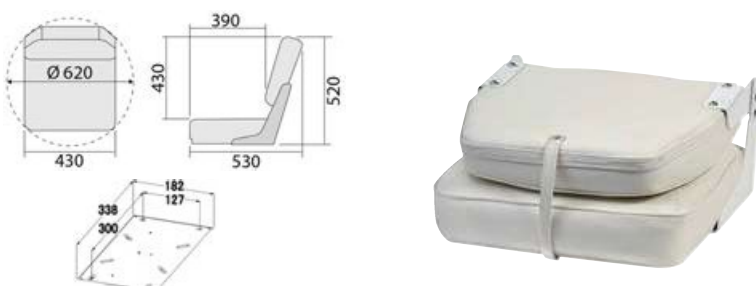



Seat with foldable backrest

Vinyl cushion, aluminum zip fasteners.

Code	Colour	mm
48.404.01	<input type="checkbox"/> White	400x467x474
48.404.02	<input checked="" type="checkbox"/> Navy blue	400x467x474
48.404.03	<input type="checkbox"/> Sand	400x467x474

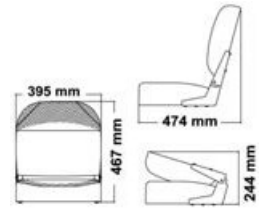

Sirocco ergonomic seat

Foldable seat with lock. HD foam core. UV-resistant upholstery. Lower fastening bores with standard centre distance.

Code	Upholstery colour
48.407.01	<input type="checkbox"/> White
48.407.04	<input checked="" type="checkbox"/> Light and dark grey

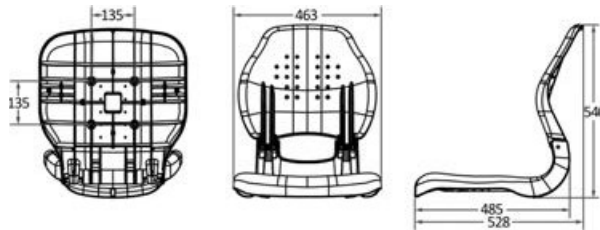

Reverso seat with rotating backrest

It can be used both forwards and backwards.

Code	Type	Colour
48.410.04	Reverso, single	<input type="checkbox"/> White RAL 9010
48.410.03	Reverso, double	<input type="checkbox"/> White RAL 9010

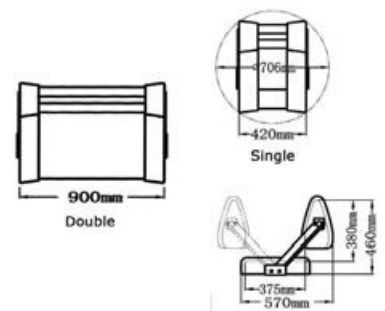

Ergonomic seat with foldable backrest

Made of **white elastic leather fabric**, thick-cushioned with moltopen core and marine **plywood** frame. Fitted with **stainless steel** hinges. Ideal as cabin seat, peak seat in open boats or dinghies.

Code	Depth mm	Width mm	Foldable hinge included
48.415.00	400	450	48.418.04



Two-place seat

Lined with **white leather fabric**, it can be mounted on storage lockers and peaks. **Foldable** backrest, it can be used in **drive position or turned backwards**.

Code	mm
48.412.00	800x400

Two-place ergonomic seat with foldable backrest

Slat bottom covered in **white elastic artificial leather** padded with moltpren.
Multi-layer plywood frame. Fitted with **stainless steel** hinge.

Code	Depth mm	Width mm	Foldable hinge included
48.415.02	400	800	48.418.04
48.415.03	400	900	48.418.04



Hinge set

Made of **stainless steel**, for seats. Fitted with stopper in two positions: **driving position and 180° sun rest position**.

Code	side mm	open mm
48.418.04	330x60	660x60

48.415.00; 48.415.02; 48.415.03 Seats suitable for this kind of hinges

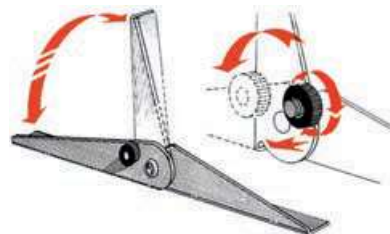

Compact seat frame

Made of **white polyethylene**, it comes with Super extra-padded cushions. For all pedestals available in our catalogue. Fitted with 8 brass threaded inserts for fixing pedestals and slides.

Code	Depth mm	Height mm	Width mm	Frame only	Set of additional cushions
48.670.06	400	490	490	48.671.06	48.672.06

Supplied without pedestal

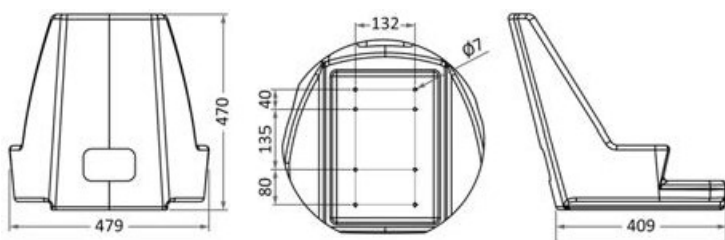

Seat frame

Made of white rotational moulded **polyethylene**, fitted with removable cushions. Ready to fit any pedestal available in our catalogue. Fitted with 8 brass threaded inserts for fixing pedestals and slides.

Code	Depth mm	Height mm	Width mm	Frame only	Set of additional cushions
48.690.00	520	480	480	48.691.00	48.692.00

Supplied without pedestal

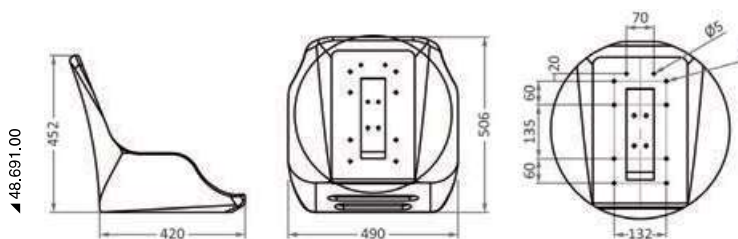

Seat frame

Made of white rotational moulded **polyethylene**. Ready to fit **any pedestal available in our catalogue**. Fitted with 8 brass threaded inserts for fixing pedestals and slides.

Code	Depth mm	Height mm	Length mm	OPTIONAL set of cushions
48.682.01	430	400	445	48.682.02

Cushions not included.





Seat frame

Made of white rotational moulded **polyethylene**, fitted with removable cushions. Weatherproof model ideal for open boats. Compact and very comfortable, ready to fit any pedestal available in our catalogue. Fitted with 8 brass threaded inserts for fixing pedestals and slides.

Code	Depth mm	Height mm	Width mm	Frame only	Set of additional cushions
48.680.08	420	470	520	48.681.08	48.682.08

Supplied without pedestal.

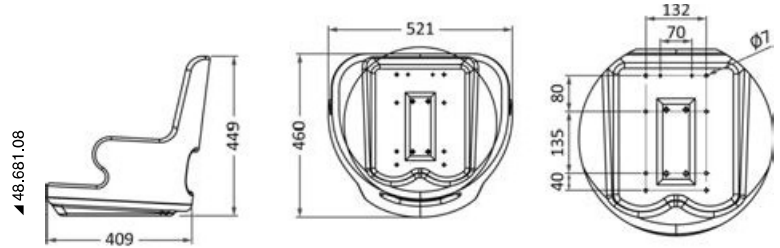

Comfort seat frame

Made of white rotational moulded polyethylene. Ready to fit any **pedestal** available in our catalogue. Fitted with 8 brass threaded inserts for fixing pedestals and slides.

Code	←→ mm				OPTIONAL set of cushions
	Seat without cushion	Seat with cushion	Backrest without cushion H	Backrest with cushion H	
48.684.01	500x440	500x530	520	700	48.684.02

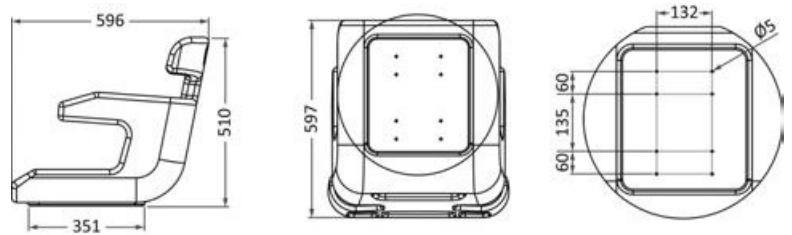

Seat

Made of **white polyethylene**, fitted with **removable white leather fabric** cushions. Weatherproof model ideal for the flybridge since it suffers **no deterioration**. Very comfortable shape. The base is fitted with **multiple stainless steel inserts** to connect to any swivelling pedestal in our catalogue. Fitted with 8 brass threaded inserts for fixing pedestals and slides.

Code	Depth mm	Height mm	Width mm	Frame only	Set of additional cushions
48.680.10	470	545	690	48.681.10	48.682.11

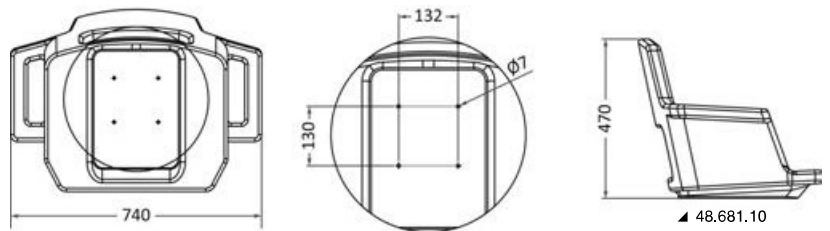

Adriatico fighting chair

Made of **white polyethylene**, fitted with side **stainless steel** handles, two partially balancing fishing rod holders on both sides, one balancing central fishing rod holder made of **aluminium**. Ready for all pedestals available in our catalogue. Industrial product featuring excellent quality at a very affordable price. **Supplied without pedestal and cushion.**

Code	mm	Cushion
48.680.07	737x410	48.680.25

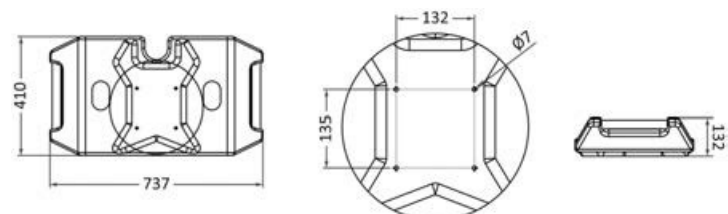

Ergonomic seat frame

Made of rotomoulded polyethylene, fitted with brass inserts (multiple on the base). It fits several pedestals and slides.

Code	Depth mm	Height mm	Width mm
48.680.14	660	610	508

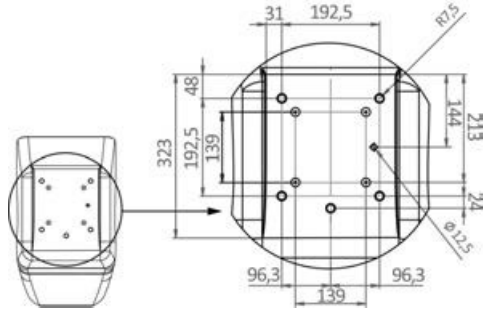

Compact padded seat with H51 flip-up bolster

Plastic and aluminium core. HD foam padding. Very compact for use in confined spaces. Ideal for pilot boats.

Code	Upholstery	Colour
48.410.05	Lined with soft vinyl	Beige
48.410.06	Lined with soft vinyl	White RAL 9010
48.410.15	Padding to be lined	- To be lined

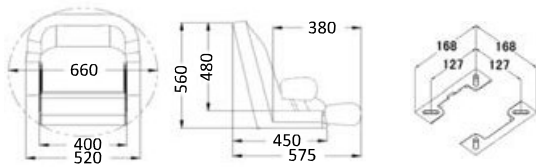

De Luxe ergonomic seat

Technopolymer core, HD foam padding, lumbar support. In compliance with the ABYC regulations.

Code	Type	Colour
48.410.08	High-quality vinyl upholstery	White RAL 9010
48.410.18	With padding, to be lined	- -

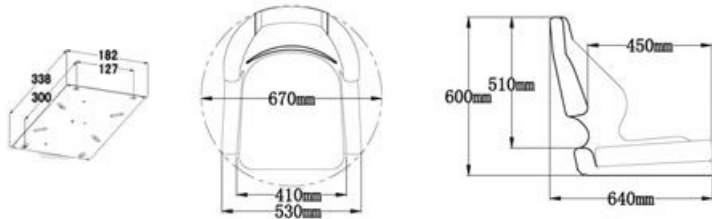

▲ Indicative picture - example of customization

Ergonomic padded seat with H52 flip-up bolster

Rotational moulded plastic core. HD foam padding. Opening in the lumbar region. In compliance with ABYC standards.

Code	Type	Colour
48.410.02	Soft vinyl upholstery	White RAL 9010
48.410.12	With padding ready to be lined	- -



▲ Indicative picture: example of customized item.



Ergonomic padded seat with H52R flip-up bolster

Plastic and aluminium core, HD foam padding.

Code	Type	Colour
48.410.07	High-quality vinyl upholstery	<input type="checkbox"/> White RAL 9010
48.410.17	With padding, to be lined	- -

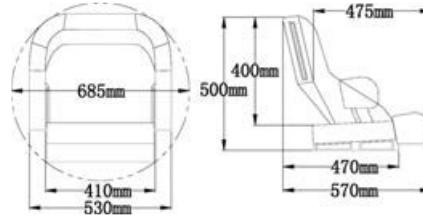

New

Ergonomic padded seat with RM52 flip-up bolster

FABRIC FEELING

Rotary moulding plastic core. HD foam padding. Hole in the lumbar area. Soft vinyl upholstery with a central diamond-shaped stitch texture with beige double seams.

Code	Type	Colour
48.410.20	Coated with high-quality vinyl	<input checked="" type="checkbox"/> Dark blue with beige seams
48.410.21	Only padding, ready to be coated	- -

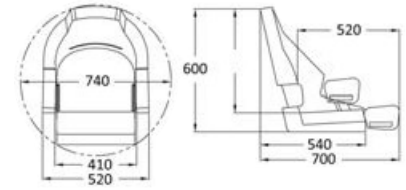

Ergonomic padded seat with H54 flip-up bolster

Rotational moulded plastic core, HD foam padding. In compliance with ABYC standards.

Code	Type	Colour
48.410.01	Soft vinyl upholstery	<input type="checkbox"/> White RAL 9010
48.410.11	Ready to be lined in your favourite colour	- -



▲ Indicative picture: customized item

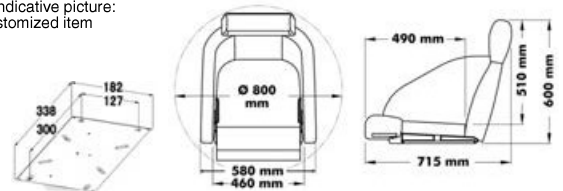

Padded ergonomic seat with flip up 3090

Rotary moulding plastic core, high-density foam padding.

Code	Type	Colour
48.410.22	Covered in soft vinyl	<input type="checkbox"/> White RAL 9010
48.410.32	With padding, ready to be covered	- -

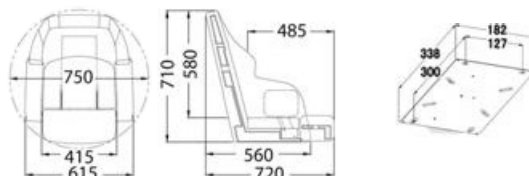

New Double ergonomic padded seat with H99 flip-up bolster

Rotary moulding plastic core. HD foam padding. Hole in the lumbar area.

Code	Type	OPTIONAL slide rail
48.410.40	With padding, ready to be covered	48.715.00

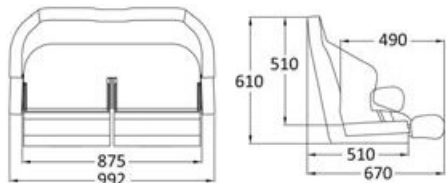

New Twin slides for double seat

48.715.00 Twin slides in anodized aluminium to fasten double seats 48.410.40. Only one of the slides is fitted with release lever for an easier sliding movement.

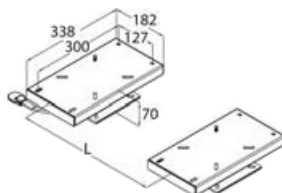

ATTWOOD Aergo seat

48.408.30 Kit including plastic frame + flip-up bolster + padding ready to be upholstered. This seat features the SAS-Shock Absorbing System that absorbs the shocks without transferring impact to the boater.

⚠ Indicative picture. The seat is supplied without upholstery. Fabric or leather fabric at customer's choice not included in the price.

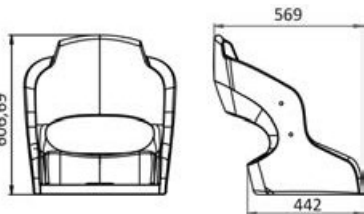
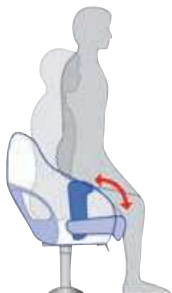

ATTWOOD Centric II ergonomic and folding seat

48.408.10 Seat + foldable backrest + 3 parts made of foam. Seat frame designed for proper water drainage. The seat is fitted with standard bushings for fastening to a pedestal. Supplied without upholstery (to be taken care of at the shipyard).

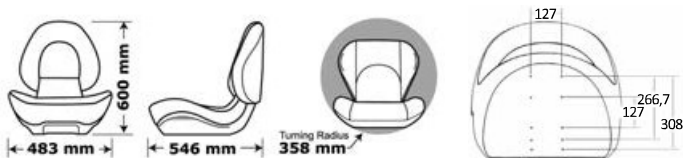

Fabric seat cover

Made of polyester fabric and waterproof polyurethane coating.

Code	AxBxH cm	Colour	Fabric deniers	For seat
48.688.01	45x55x53	Grey	300 D	Single-seater
48.688.02	60x60x65	Grey	300 D	Single-seater
48.688.03	53x90x89	Grey	300 D	Two-seat



Seat pedestals and slides

OSCOLATI



Anodized aluminium swivel pedestal with seat mount

MADE IN ITALY

Fitted with antifriction **nylon** bushings. Accurate finish. Mirror-finish anodized tube. 230-mm Ø tube.

Code	Height mm	Type	Upper base	Mounting base	Tube Ø mm	Base Ø mm
48.660.01	300	Fixed	reinforced nylon	polished	80	230
48.650.01	300	Fixed	aluminium	polished	80	230
48.660.02	450	Fixed	reinforced nylon	polished	80	230
48.650.02	450	Fixed	aluminium	polished	80	230
48.660.00	450/620	Telescopic	reinforced nylon	polished	80/73	230
48.650.00	450/620	Telescopic	aluminium	polished	80/73	230

Customized heights on request (min. 10 pcs)

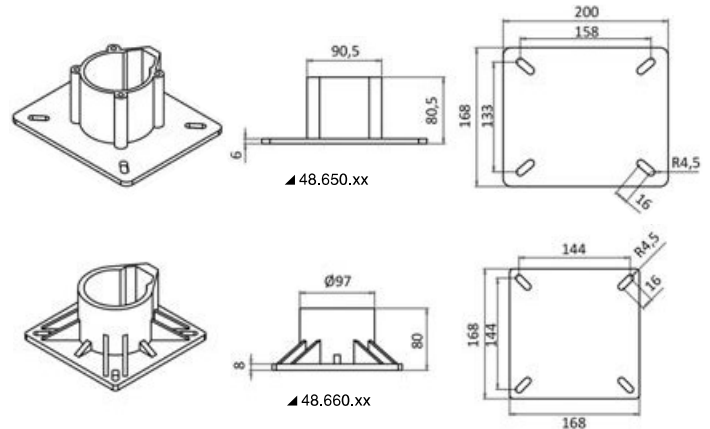

Pedestal with swivel slide

MADE IN ITALY

Fitted with anti-friction nylon bushing. Fine finish. Mirror-polished anodized tubes.

Code	Height mm	Type	Base mounting	Pedestal Ø mm	Base Ø mm
48.630.01	300	Fixed	polished	80	230
48.630.02	450	Fixed	polished	80	230
48.630.00	450/620	Telescopic	polished	80/73	230

Customized heights on request (min. 10 pcs).

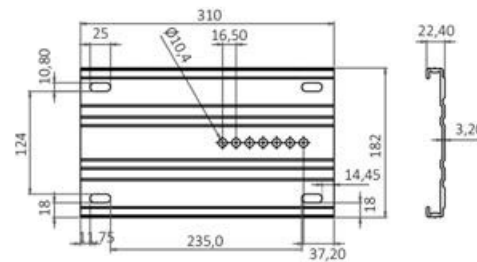

Pedestal with swivel seat mount

Base and pedestal made of anodized aluminium + grey coated aluminium swivel seat mount.

Code	H mm	Type	Pedestal Ø mm	Base Ø mm
48.709.98	280/380	Telescopic	73/60	228
48.709.99	340/470	Telescopic	73/60	228
48.710.00	430/630	Telescopic	73/60	228

Pedestal with swivel slide

Base and pedestal made of anodized aluminium + anodized aluminium swivel slide.

Code	H mm	Type	Pedestal Ø mm	Base Ø mm
48.710.98	280/380	Telescopic	73/60	228
48.710.99	340/470	Telescopic	73/60	228
48.711.00	430/630	Telescopic	73/60	228
48.711.01	330	Fixed	73	228
48.711.02	457	Fixed	73	228



Mirror-polished pedestal with swivel slide

Base and pedestal made of mirror-polished anodized aluminium + anodized aluminium swivel slide.

Code	H mm	Type	Pedestal Ø mm	Base Ø mm
48.711.98	295/395	Telescopic	87/73	228
48.711.99	340/470	Telescopic	87/73	228
48.712.00	430/630	Telescopic	87/73	228
48.712.02*	457	Fixed	87	228

* To be cut to size



Pedestal with seat mount

GAS SPRING / MOLLA A GAS

Made of mirror-polished anodized aluminium, fitted with large diameter bases and thick tubes. It matches any seat frame.

Code	Height mm	Type	Table plate mm	Pedestal Ø mm	Base Ø mm	Base
48.703.58	300/400	Telescopic	335x185	88/73	305	Polished
48.703.59	350/480	Telescopic	335x185	88/73	305	Polished
48.703.60	460/595	Telescopic	335x185	88/73	305	Polished
48.704.61	530/710	Telescopic	338x182	87	305	Polished

Customized height on request (min. 10 pcs).



New Pedestal with seat mount

Made of mirror-polished anodized aluminium, fitted with large diameter bases and thick tubes. It matches any seat frame.

Code	Height mm	Type	Table plate mm	Pedestal Ø mm	Base Ø mm	Base
48.703.58-R1	300/400	Telescopic	338x182	88/73	305	Polished
48.703.59-R1	350/470	Telescopic	338x182	88/73	305	Polished
48.703.60-R1	435/635	Telescopic	338x182	88/73	305	Polished





Foldable footrest board

Anodized aluminium.

Code	Neck (D) Ø mm	Matching seat mounts (with 87-mm Ø pedestal)	mm
48.715.01	87	48.703.58/59/60; 48.711.98/99; 48.712.00	400x220x400 (overhang)

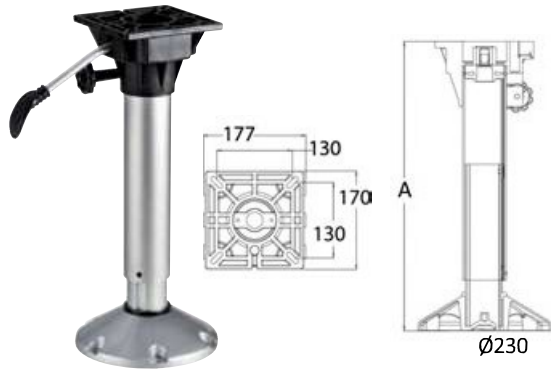
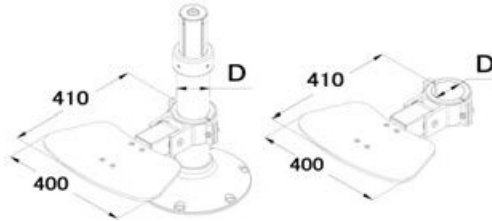

Waverider adjustable swivel pedestal with seat mount with shock absorber

SHOCK ABSORBER

Adjustable height with gas spring. Fitted with internal shock absorber to absorb the boat impact against the waves. Epoxy-coated anodized aluminium base. Anodized aluminium tubes. Nylon/fiberglass seat mount with universal bores.

Code	Height A mm	Type	Pedestal Ø mm	Base Ø mm
48.707.01	340/450	Telescopic	75/65	230
48.707.02	500/630	Telescopic	75/65	230
48.707.03	580/710	Telescopic	75/65	230



Waverider pedestal with seat mount, shock absorber, swivel support and outer base

SHOCK ABSORBER

Adjustable height with gas spring. Fitted with internal shock absorber to absorb the boat impact against the waves. It can be removed from its 228-mm Ø base. Anodized aluminium tubes. Nylon/fiberglass seat mount with universal bores.

Code	Height mm	Type	Column Ø mm	Additional snap-in base
48.707.23	370/450	Telescopic	75/65	48.707.30
48.707.21	500/630	-	75/65	-
48.707.22	580/710	-	75/65	-



Waverider pedestal with seat mount, shock absorber, swivel support and

SHOCK ABSORBER

Adjustable height with gas spring. Fitted with internal shock absorber to absorb the boat impact against the waves. It can be removed from its 228-mm Ø base. Anodized aluminium tubes. Nylon/fiberglass seat mount with universal bores.

Code	Height mm	Type	Column Ø mm	Additional snap-in base
48.707.10	310/390	Telescopic	75/65	48.707.20
48.707.11	440/570	Telescopic	75/65	48.707.20
48.707.12	520/650	Telescopic	75/65	48.707.20



Slide kit for pedestals

Universal for all aluminium models. Upper swivelling joint, 150-mm stroke. Made of nylon/fiberglass and aluminium for the slide.

Code	Tube Ø mm	For pedestals
48.692.04	73	Telescopic
48.692.05	80	Fixed

New Electric slide for seats

Made of high-resistance anodized aluminium.
Very silent and smooth operation with the 12V electric motor.

Code	Type
48.716.00	Electric slide

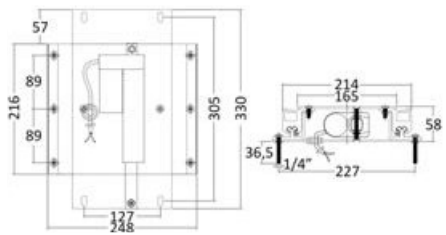

Swivel slide

Made of anodized aluminium, it fits any 73-mm Ø pedestal.

Code	Type
48.713.00	Slide

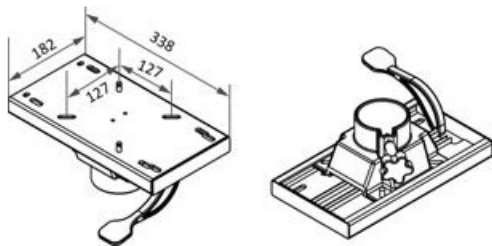

Slide for seats

48.714.00 To be fixed to a flat surface. Made of anodized aluminium. It matches any rotating base such as 48.648.03

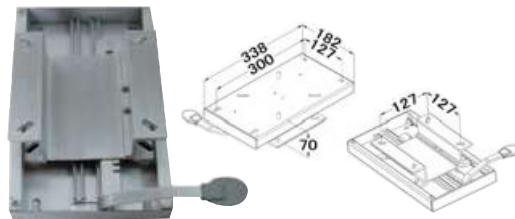

Rotating and removable base

Quick release base. Locked forward position and 360° friction rotation.

Code	Rotation	Material	mm
48.648.15	360° + locked forward position	Plastic	173x173

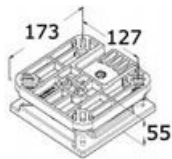

Friction rotating base for seats

Ideal for fishermen as it can rotate as wished. Ready to match any pedestal in our catalogue. Aluminium seats and other seats in our catalogue.

Code	Rotation	Material
48.648.00	on one track with ball bearings	Painted steel
48.648.01	on one track with ball bearings	Stainless steel
48.648.03	on one track with ball bearings + snap lock with handle	Stainless steel

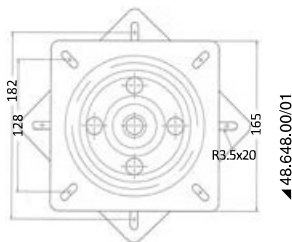
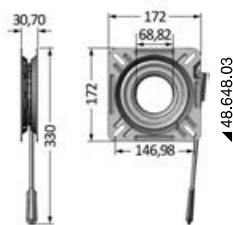
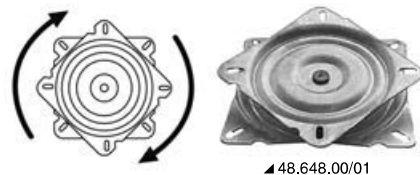



Foldable footrest board

Made of epoxy-resin coated light alloy. Real TEAK platform.

Code	Platform mm	Open footrest board mm		Folded footrest board mm	
		overhang	support height	overhang	support height
48.587.00	300x150	200	185	80	244



Non-slip footrest board with frame

AISI 316

Made of mirror-polished **AISI316 stainless steel**, soft black plastic insert, fitted with central **WHITE LED** built-in light.

Code	mm
40.523.01	213x57
40.523.02	222x86



Footrest board

Made of **chromed brass and rubber**, comfortable and elegant.

Code	Length mm
40.520.01	230x80

Table pedestals and legs

OSCULATI



48.417.90



48.417.90

White ABS table

Fitted with housings for mugs, glasses or bottles. It comes with plugs to close the housings for a totally flat surface.

Code	Version	No of glass housings	Ready for	mm
48.417.90	oval	2	Coupling with bases 48.418.03; 48.418.20; 48.418.22; 48.418.24*	770x510
48.417.92	rectangular	4	Coupling with bases 48.418.03; 48.418.20; 48.418.22; 48.418.24*	810x510

* And any base having max 178-mm Ø to be flush mounted on the lower side of the table.



48.417.92



48.417.50



48.417.51



Composite material table

Made of sturdy composite material. Snap mounting on its dedicated bases.

Code	Type	Colour	For	mm
48.417.50	Round	White	48.417.60; 48.417.61; 48.417.63; 48.417.67	610
48.417.51	Oval	White	48.417.60; 48.417.61; 48.417.63; 48.417.67	762x457
48.417.52	Rectangular	White	48.417.60; 48.417.61; 48.417.63; 48.417.67	762 x 460



48.417.52

Spare bases for conical table pedestals

Code	Outer Ø mm	Material	For table pedestal	Tube Ø mm
48.416.02	160	Aluminium	48.418.01; 48.418.11; 48.418.20	60
48.416.03	165	Aluminium	48.418.01; 48.418.11; 48.418.20	60
48.416.12	160	White painted aluminium	48.418.22	60
48.416.13	165	White painted aluminium	48.418.22	60
48.416.22	170	Polished anodized aluminium	48.418.21	60
48.416.23	160	Polished anodized aluminium	48.418.21	60
48.416.33	240	Polished anodized aluminium	48.418.28	60
48.416.42	280	Sandblasted anodized aluminium	48.418.27	80
48.416.43	250	Polished anodized aluminium	48.418.27	80

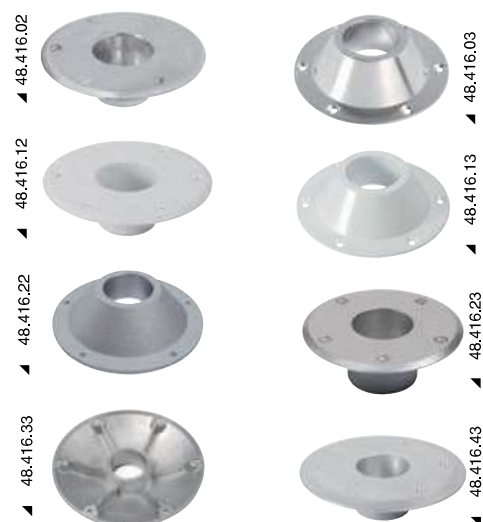
Aluminium table pedestal with external base

Two identical and interchangeable bases not needing a recess on the floor and on the table. 50-mm overhang from the base.

Code	Height mm	Tube Ø mm	Tube	Base Ø mm	Base	Spare base
48.418.28	700	60	Anodized aluminium	240	Polished anodized aluminium	48.416.33

Stainless steel table pedestal

Made of a tube fitted with two base joints, one to be fitted flush with the floor, the other to be mounted under the table top. The tube is fitted with a self-locking system on the ends so the table can be mounted and disassembled in a matter of seconds.

Code	Height mm	Tube Ø mm	Tube	Table base Ø mm	Floor recess base Ø mm	Base	Spare floor base	Spare table base
48.418.01	700	60	Chrome-plated steel	165	160	Diecast aluminium	48.416.02	48.416.03
48.418.11	700	60	Mirror-polished SS	165	160	Diecast aluminium	48.416.02	48.416.03

OSCULATI

Anodized aluminium table pedestal

Two diecast aluminium bases (one external and one for flush mounting) model 48.418.01 and an anodized aluminium tube model 48.418.21. Recommended for indoor installation, only.

Code	Height mm	Tube Ø mm	Tube	Table base Ø mm	Floor recess base Ø mm	Base	Spare floor base	Spare table base
48.418.20	700	60	Anodized aluminium	165	160	Diecast aluminium	48.416.02	48.416.03

OSCULATI

Coated aluminium table pedestal

White epoxy coated finish. It includes two aluminium bases (one external and one for flush mounting) model 48.418.01 and an anodized aluminium tube model 48.418.21.

Code	Height mm	Tube Ø mm	Tube	Table base Ø mm	Floor recess base Ø mm	Base	Spare floor base	Spare table base
48.418.22	700	60	White coated aluminium	165	160	White coated aluminium	48.416.12	48.416.13

OSCULATI

White epoxy coated.

Plug

Made of white plastic, used to cover the bores of table bases on the floor.

Code	For bases
48.418.17	48.418.21
48.418.18	48.418.01; 48.418.11; 48.418.20; 48.418.22



OSCULATI



Heavy duty table pedestal

Two **anodized aluminium** bases, one mirror-polished for recess mounting, the other external, and a 60-mm Ø **anodized aluminium** tube with conical fittings.

Code	Height mm	Tube Ø mm	Tube	Table base Ø mm	Floor recess base Ø mm	Base	Spare floor base	Spare table base
48.418.21	700	60	Anodized aluminium	170	160	Anodized aluminium	48.416.23	48.416.22

OSCULATI



Polished stainless steel table pedestal

AISI 316

Code	Height mm	Tube Ø mm	Tube	Base Ø mm	Base
48.418.03	670	50	Polished SS	160	Polished SS

OSCULATI



Heavy Duty table pedestal

Two **anodized aluminium** bases (one for recess mounting, the other external) and a 80-mm Ø **anodized aluminium** tube with conical fittings.

Code	Height mm	Tube Ø mm	Tube	Table base Ø mm	Floor recess base Ø mm	Base	Spare floor base	Spare table base
48.418.27	675	80	Polished anodized aluminium	280	250	Anodized aluminium	48.416.43	48.416.42



Fastening bracket for table legs

34.358.60 60-mm Ø. Made of black santoprene, for 60- to 63-mm Ø tubes.

Thread Lock aluminium table pedestal for tables 48.417.50/51/52

Without upper base, it perfectly embeds into the housing of the tables 48.417.50/51/52. Made of anodized aluminium. The pedestal screws into the base by means of the ingenious and **extremely stable** Tread Lock system. Floor **recessless** mounting of the base onto the deck floor, overhang of as little as 20 mm.

Code	Height H mm	Type	A/B/C Pedestal Ø mm	For table	Finish
48.417.60	685	Fixed		48.417.50/51/52	Satin-finish
48.417.61	500/700	Telescopic	60/50	48.417.50/51/52	Mirror-polished
48.417.63	New 450/700	Telescopic	73/60	48.417.50/51/52	Mirror-polished
48.417.67	New 450/775	Tri-telescopic	73/60/50	48.417.50/51/52	Mirror-polished

48.417.62 *OPTIONAL* Only base for 48.417.xx. To be used as table pedestal in the cabin and in the cockpit.

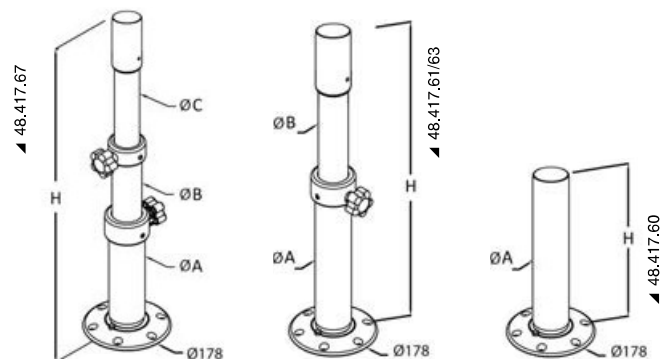
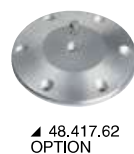

Thread Lock aluminium table pedestal for general tables

Made of anodized aluminium. The pedestal screws into the base by means of the ingenious and **extremely stable** Tread Lock system. Floor **recessless** mounting of the base onto the deck floor, overhang of as little as 20 mm.

Code	Height H mm	Type	A/B/C Pedestal Ø mm	Version	Finish
48.417.64	689	Fixed	60	For generic tables	Satin-finish
48.417.65	500/700	Telescopic	60/50	For generic tables	Mirror-polished
48.417.66 New	450/700	Telescopic	73/60	For generic tables	Mirror-polished
48.417.68 New	450/775	Tri-telescopic	73/60/50	For generic tables	Mirror-polished

 **48.417.62** *OPTIONAL* Only base for 48.417.xx. To be used as table pedestal in the cabin and in the cockpit.

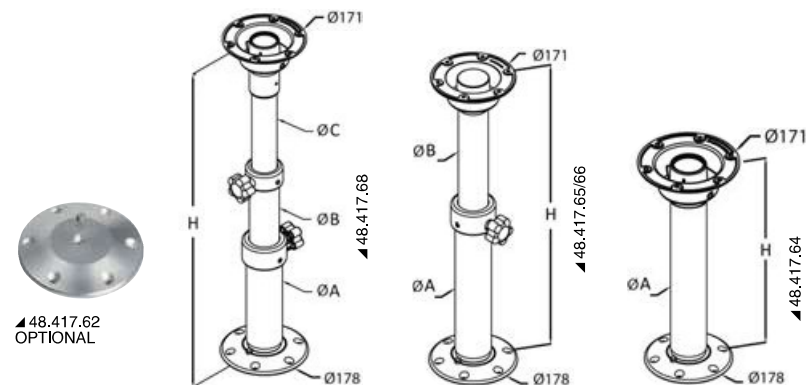

Aluminium table pedestal



Made of **anodized aluminium**, fitted with antifriction nylon bushing. Fine finish.

Code	Height mm	Base Ø mm	Pedestal Ø mm
48.651.00	580/780 adjustable	230	80/73

Removable table pedestal



Made of **anodized aluminium**. Very thin upper and lower bases (15-mm overhang), recessless mounting. More heights on request.

Code	Tube length mm	Ø mm	Base Ø mm
48.418.24	700	80	200

Tri-telescopic aluminium table pedestal

Manually-operated anodized aluminium pedestal. No need to bore the floor for downstroke.

Code	Height mm	Base Ø mm	Tube Ø mm	Table plate
48.719.01	295/690	228	73/60/50	182x182

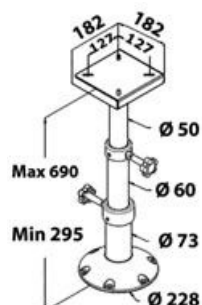

OSCULATI

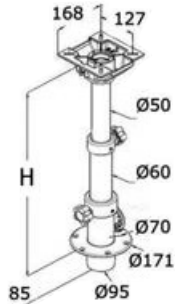

Removable tri-telescopic table pedestal

GAS SPRING Made of anodized aluminium. Flush mount base and plug.

Code	Type	Height H mm	Base Ø mm	Tube Ø mm	Upper aluminium base included mm	Optional additional base*
48.421.01	Standard	290/690	171	70/60/50	168x168	48.421.12
48.421.03	Gas spring	320/690	171	70/60/50	168x168	48.421.12

* Base plate needed to use the same pedestal in two different places of the boat. Remove the plastic insert from the hole centre when using the base plate with pedestal 48.421.03.



OSCULATI

Heavy Duty Giant table pedestal

GAS SPRING / MOLLA A GAS Made of mirror-polished anodized aluminium. Fitted with **gas spring** for upstroke. **No need to bore the floor for downstroke.** Tri-telescopic.



Code	Height mm	Extra-flat base Ø mm	Tube Ø mm	Table plate mm	OPTIONAL extension kit
48.720.01	345/714	305	100/88/72	305x305	48.724.01; 48.724.02



OSCULATI

Giant Deluxe table pedestal

Giant table pedestal

48.720.03 - Deluxe version

GAS SPRING / MOLLA A GAS

SS HANDLES / COLLARE INOX

Made of mirror-polished anodized aluminium. **Stainless steel clamping collars** for a very stable and sturdy pedestal. Fitted with gas spring for upstroke. No need to bore the floor for downstroke. Tri-telescopic.

Code	Height mm	Extra-flat base Ø mm	Tube Ø mm	Table plate mm	OPTIONAL extension kit
48.720.03	345/714	305	100/88/72	305x305	48.724.01; 48.724.02

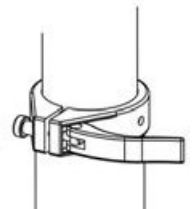
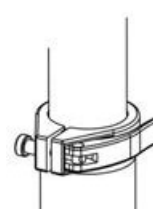

New Giant Heavy Duty black table pedestal

Made of black anodized aluminium with black plastic fastening collars for a total black effect. Fitted with gas spring for upstroke, no need to bore the floor for downstroke. Tri-telescopic.

Code	Height mm	Extra-flat base Ø mm	Tube Ø mm	Table plate mm	OPTIONAL extension kit
48.720.04	345/714	305	100/88/72	305x305	48.724.01; 48.724.02

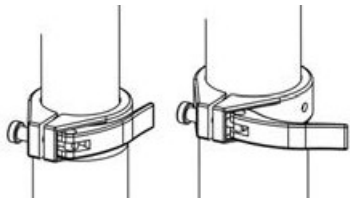

Heavy Duty table pedestal, square baseplate

GAS SPRING / MOLLA A GAS **SS HANDLES / COLLARE INOX**

Made of mirror-polished anodized aluminium. **Stainless steel clamping collars** for a stable and sturdy pedestal. Fitted with **gas spring** for upstroke, **no need to bore the floor for downstroke**. Tri-telescopic. Polished and anodized aluminium base with milling finish for possible installation and sliding on the floor.

Code	Height mm	Base mm	Tube Ø mm	Table plate mm	OPTIONAL extension kit
48.721.02	341/714	500x500	100/88/72	305x305	48.724.01; 48.724.02



Giant Twins double table pedestal

GAS SPRING / MOLLA A GAS **SS HANDLES / COLLARE INOX**

Made of mirror-polished anodized aluminium. **Stainless steel clamping collars** for a stable and sturdy pedestal. Fitted with double gas spring for upstroke, no need to bore the floor for downstroke. Tri-telescopic. **Suitable for large-size tables.**

Code	Height mm	Base mm	Tube Ø mm	Table plate mm	OPTIONAL extension kit	Base mounting
48.721.08	341/714	615x300	100/88/72	610x305	48.724.01; 48.724.02	10 x M10 flat countersunk head screws

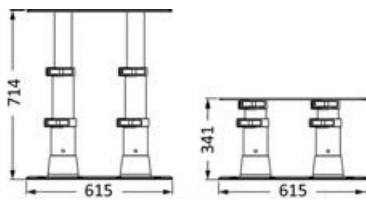

Slides for tip-top tables

To apply under table plates 48.720.01 and 48.720.03 (yet ready). Anodized aluminium slides and mirror-polished AISI316 stainless steel brackets and telescopic cylinders.

Code	Description
48.724.01	Kit for extension on 1 side
48.724.02	Kit for extension of second side*

* To be ordered in addition to 48.724.01

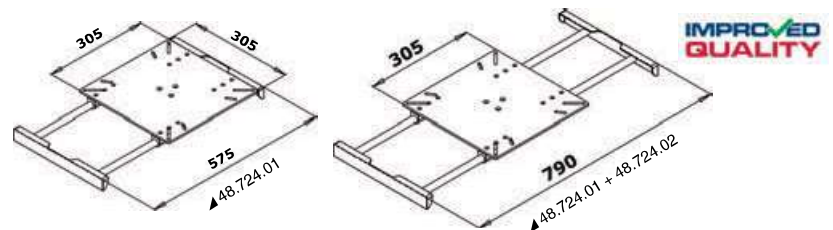



Swivelling telescopic table pedestal

Made of mirror-polished stainless steel. For tables.

Code	Min. height mm	Max. height mm	Tube Ø mm	Arm length mm
48.418.02	500	720	60	740x430

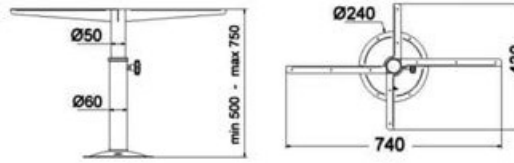

Universal telescopic swivelling pedestal

Adjustable in height, made of stainless steel. Very sturdy and functional. Pedestal for tables and seats.

Code	Height min mm	Max height mm	Tube Ø mm	Base Ø mm
48.418.00	540	720	92	320

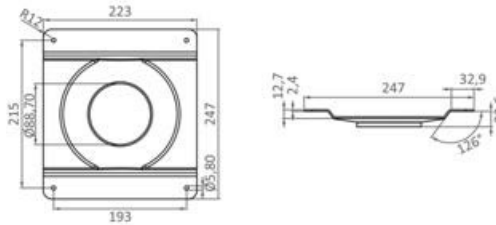

Stainless steel telescopic table pedestal

Made of mirror-polished AISI316 stainless steel with double extension operated by gas spring. Weight: 8 kg. **No need to bore the floor for downstroke.**

Code	Height mm	Base Ø mm	Table plate mm
48.730.01	325/720	220	200x165

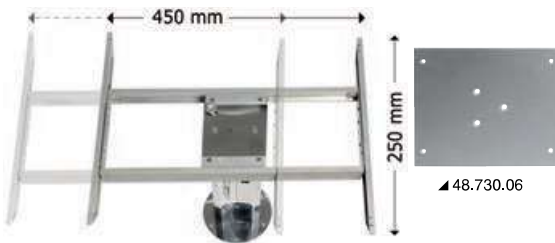

Bi-directional shifter for table pedestals

Made of anodized aluminium, to be fastened on base 48.730.01. It allows to shift the table along two axis: 450 mm longitudinally and 250 mm crosswise.

Code	External size mm
48.730.05	680x560

 **48.730.06** Plate to be fixed on pedestals 48.720.01, 48.720.03 and 48.721.02

OSCOLATI

Table extension universal kit

UNIVERSAL 48.726.00 To be screwed under any folded table where the handle/support is hidden. When you need to unfold the table, slide it out and it will work as support for the tip-top table. Stainless steel plate and slides, POM bushings for optimum and smooth sliding.

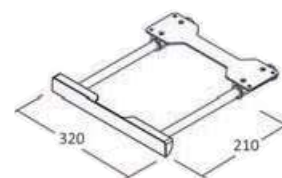

ROUND-ALU, SQUARE-ALU and SQUARE accessories for electrical table pedestals

Code	Description	For pedestals
48.749.01	(ON) - OFF - (ON) switch	48.740.xx; 48.743.xx; 48.737.xx; 48.739.xx
48.749.05	Receiver to use radio remote control 48.749.08	48.740.xx
48.749.06	Receiver to use radio remote control 48.749.08 with function to synchronize 2 pedestals of the same table	48.739.xx
48.749.08	4-way radio remote control to operate separate table pedestals	48.740.xx 48.743.xx
48.749.10	Synchronization receiver for 2 pedestal of the same table	48.737.xx



Round-Alu electrical table pedestal

ELECTRIC Made of anodized aluminium with components for indoor and outdoor use. A 6-pole switch is needed to operate the pedestals and reverse polarity. Heights on request for a minimum order quantity of 10 pieces. It can be used in pairs by purchasing the synchronization receiver 48.749.10.

Code	V	No. of heights	Max A	Speed	Height when retracted mm	Height when extended mm	Baseplate Ø mm	Table plate Ø mm	Max load kg
48.737.12	12	3	10	12 mm/sec	358	758	200	200	100



Square-Alu electrical table pedestal

ELECTRIC Made of anodized aluminium with components for indoor and outdoor use. A 6-pole switch is needed to operate the pedestals and reverse polarity. Heights on request for a minimum order quantity of 10 pieces. It can be used in pairs by purchasing the synchronization receiver 48.749.10.

Code	V	No. of heights	Max A	Speed	Height when retracted mm	Height when extended mm	Baseplate mm	Table plate mm	Max load kg
48.739.12	12	3	10	18	358	758	200x200	200x200	50
48.739.24	24	3	5	18	358	758	200x200	200x200	50

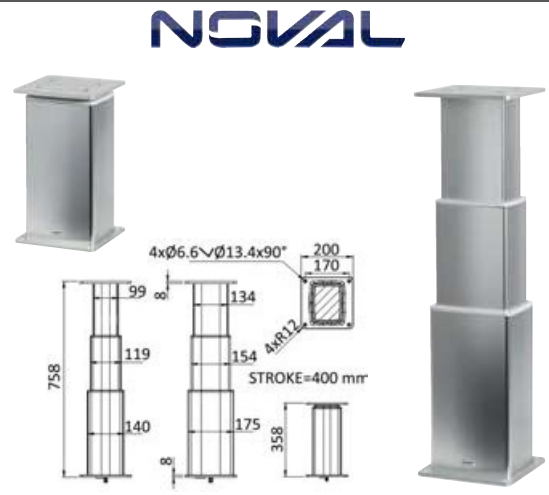

Square 2- or 3-stage electrical table pedestal

ELECTRIC STAINLESS STEEL

Made of mirror-polished AISI 316 stainless steel. For indoor and outdoor installation. A 6-pole switch is needed to reverse polarity and operate the pedestals. The 3-stage version can be used in pair using synchronization box 48.749.06. Height can be customized for minimum orders of at least 10 pcs.

Code	V	No. of heights	Max A	Speed	Height A mm	Height B mm	Base CxD mm	Table plate ExF mm	Max load kg
48.740.12	12	2	10	12 mm/sec	404	674	250x250	188x250	100
48.740.24	24	2	5	12 mm/sec	404	674	250x250	188x250	100
48.743.12	12	3	10	15 mm/sec	313	637	355x280	355x280	100
48.743.24	24	3	5	15 mm/sec	313	637	355x280	355x280	100



NOVAL

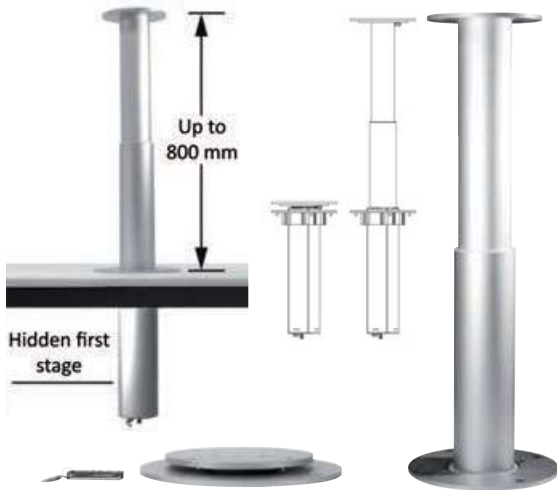

Foldable 2-stage electrical table pedestal

ELECTRIC

Made of anodized aluminium with parts for indoor and outdoor installation. To be recessed into the floor, fixed or 90° swivelling system of the table available. A 6-pole switch is needed to reverse polarity and operate the pedestals. Height can be customized for minimum orders of at least 10 pcs.

Code	V	No. of heights	Max A	Speed	Height when folded mm	Height when open mm	Ø upper plate mm	Ø lower plate mm	Max load kg	Upper plate type	OPTIONAL switch
48.745.12	12	2	10	9-12 mm/sec	45	820	270	255	100	Swivelling at 90°	48.749.01
48.746.12	12	2	10	9-12 mm/sec	26	801	200	255	100	Fixed	48.749.01



Folding arms for tip-top tables

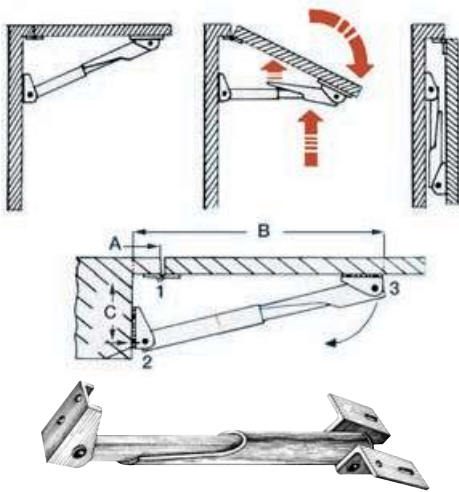

Rakego foldable arm for tables

Made of anodized aluminium, easy to use, light weight, rust-proof, easy to install and very sturdy.

Code	Ø mm	A mm	B mm	C mm	Max load	
					P1 kg	P2 kg
48.202.00	20	20/30	150	14	60	30
48.302.00	20	23/35	247	44	60	30
48.452.50	25	28/50	402	87	120	60
48.602.50	25	28/40	549	137	140	80

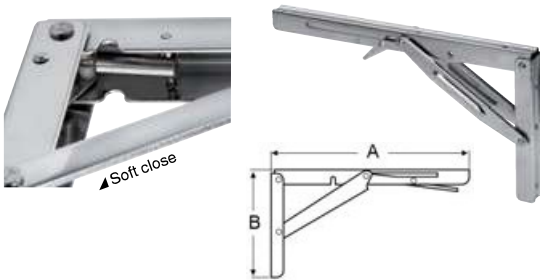
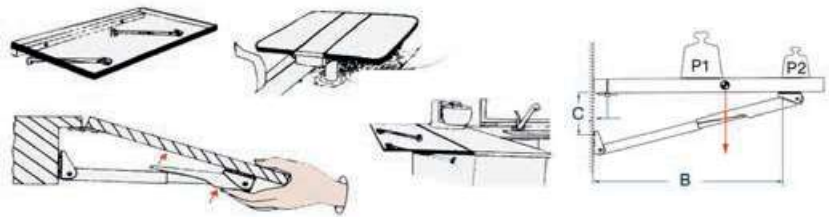

Folding arm for tables

AISI 316 Made of polished stainless steel.

Code	A mm	B mm	Max load kg	Type	Lock
48.615.00	300	160	150	-	Open
48.615.03	300	160	250	-	Open
48.615.01	305	165	150	-	Open/close
48.615.04	305	165	250	-	Open/close
48.615.10	300	160	150	Soft Close*	Open
48.617.00	200	116	150	Short arm	Open

* Soft close when the device is released



Folding arm for tables and seats

Mirror-polished stainless steel, HEAVY DUTY model.

Code	A mm	B mm	Max load kg	Lock
48.616.00	320	165	100	Open only

They can also be used in pairs

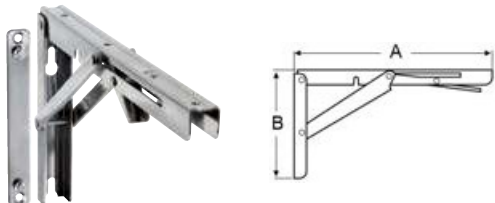

Slip-off folding arms for tables

Made of polished stainless steel, it can be slipped off their bulkhead support. Sold in pairs. 300-kg max allowable load per pair.

Code	A mm	B mm	Max load kg	Type	Lock
48.615.02	305	165	300 (pair)	Pair	Open/closed

Sold with bulkhead supports to pull out the arm.

Stern and bow gangplanks and dolphin strikers

Dolphin striker

AISI 316 Made of mirror-polished AISI316 stainless steel and real teak walking surface. Adjustable strut.

Code	Tube Ø mm	AxBxC mm
48.471.01	32	680x395x280
48.471.05	32	750x500x330
48.471.06	40	1180x590x330

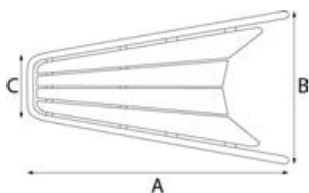

Dolphin striker with hinged bow roller for anchors

AISI 316 Made of mirror-polished AISI316 stainless steel and real teak walking surface. Adjustable strut.

Code	Tube Ø mm	AxBxC mm
48.471.04	32	750x500x330
48.471.08	40	1180x590x330

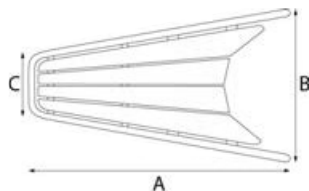

Racing Performance dolphin striker

Heavy duty version with adjustable roller housing for anchors up to 20 kg (compatible with the most common types) and adjustable joint for gennaker/Code-0. Ready to fit a telescopic ladder in its lower part.

Made of polished AISI316 stainless steel + teak walking surface.

Code	A mm	B mm	Tube Ø mm	For boats m	For gennaker max m²	For Code-0 max pull kg	Anchor max kg	OPTIONAL bow roller	OPTIONAL ladder
48.472.01	1050	436 ± 50	32	7,80 / 10	80	1500	11	48.472.10	48.472.30
48.472.03	1172	533 ± 50	41.5	9,60 / 12,60	115	2500	20	48.472.10	48.472.40
48.472.05	1406	590 ± 50	41.5	10,80 / 14,10	130	2500	20	48.472.10	48.472.40

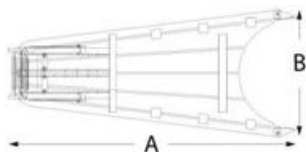

Accessories for Racing Performance dolphin striker 48.472.01/03/05

Code	Description	mm				
		A	B	C	D	E (Max length)
48.472.10	Universal hinged bow roller for 11/20 kg anchors	203,4	185	247,7	-	-
48.472.30	3-step telescopic ladder for 40,472,01	409,2	300	295	65	890
48.472.40	3-step telescopic ladder for 40,472,03/05	409,2	300	284	65	890

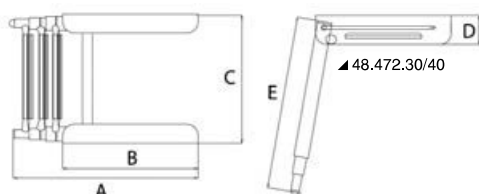
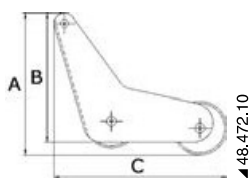



Dolphin striker with 2- and 3-step telescopic ladder

AISI 316

Made of mirror-polished AISI316 stainless steel and real teak walking surface. Adjustable strut.

Code	No of steps	Tube Ø mm	AxBxC mm
48.471.02	2	32	700x395x280
48.471.03	3	32	720x395x280

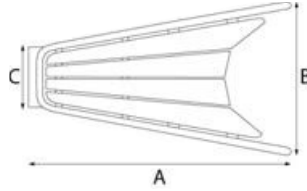

Fiberglass technopolymer stern platform

AISI316 stainless steel frame. Universal version.

Code	Width cm	Depth cm	Tube Ø mm	Ladder
48.419.60	45	35	22	No
48.419.61	45	35	22	Yes, 3 steps, telescopic



49.540.03 Spare ladder



Mini platform

Suitable for dinghies or confined spaces. Iroko walking surface, fine finish.

Code	Width cm	depth cm	U fitting INCLUDED	SS tube Ø mm	Ladder
48.420.08	34	36	48.420.40	22	No
48.420.09	34	36	48.420.40	22	Yes, 2 foldable steps

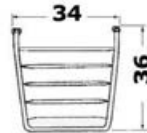

Stern platform

Made of stainless steel, with Iroko walking surface.

Code	Width A cm	Depth cm	Ladder
48.420.05	45	45	No
48.420.06	45	45	Yes, 2 foldable steps
48.420.04	58	52	No
48.420.03	58	52	Yes, 2 foldable steps



48.420.40 4 joints INCLUDED

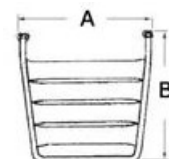

TL platform

Made of mirror-polished AISI316 stainless steel with **Iroko** grating. **Fitted with lower struts.**

Code	Length cm	Depth cm	Ladder	OPTIONAL Ladder
48.419.51	45	39	Without ladder	49.543.33
48.419.50	45	39	Yes, 3 steps, telescopic, hidden	49.543.33



Stern gangplank for sailing boats/motorsailers

Made of mirror-polished AISI316 stainless steel with real **Iroko** walking surface. Adjustable fixing joints.

Code	Length mm	Depth mm	Tube Ø mm	OPTIONAL ladder
48.443.01	840	380	25	49.543.03
48.443.02	1000	380	25	49.543.03
48.443.03	1090	600	25	49.543.03; 49.543.04
48.443.04	1310	600	25	49.543.03; 49.543.04

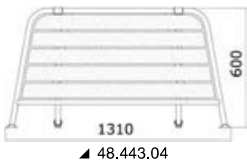
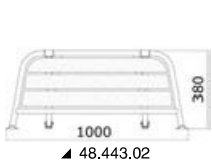
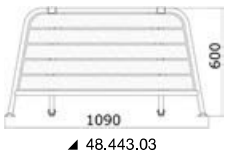
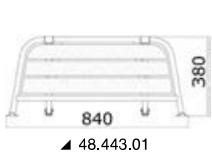

Stern gangplank

Made of 25-mm Ø polished AISI316 stainless steel tube with articulated joints. **Iroko** walking surface.

Code	Width cm	Depth cm	Struts	OPTIONAL ladder
48.420.10	130	55	2	49.543.03/04
48.420.11	170	55	2	49.543.03/04
48.420.12	200	55	3	49.543.03/04
48.420.13	230	55	3	49.543.03/04



Platform – gangplank – ladder

Made of 25-mm Ø stainless steel tube, fitted with **Iroko** walking surface and mounting accessories.

Code	A cm	C cm	D cm	E cm
48.410.00	65	60	115	32
48.411.00	94	68	140	40

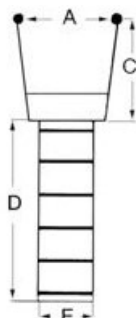

Gangplank for round stern hulls (gozzo boats / pilot boats)

Made of mirror-polished AISI316 stainless steel with real **Iroko** walking surface. Articulated terminal joints to adapt to any stern.



Code	RIGHT/LEFT element mm	For boats m	Tube Ø mm	OPTIONAL ladder
48.443.40	530x430x885	6,60/8,40	25	48.575.06
48.443.41	650x470x950	8/10,20	25	48.575.06

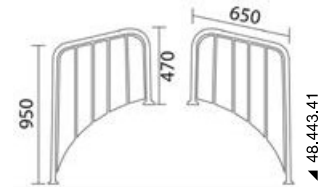

6-step foldable ladder for 48.443.40/41

Made of mirror-polished AISI316 stainless steel.

Code	Length mm	Width mm
48.575.06	1320	280

Swiveling ball joint for platforms, gangplanks, awnings, outboard engine brackets

To be fitted **outside** the tube. 3-screw mounting. Mirror-polished AISI316 stainless steel.



Code	For tube Ø mm
48.420.25	25

T joint



Made of **stainless steel**, fitted with antifriction bushings.

Code	Ø mm
48.420.30	25
48.420.31	22

U plate



For mounting of platforms or ladders.

Code	For tube Ø mm
48.420.40	22

Bracket

Made of **stainless steel**, for mounting of ladders onto platforms.



Code	Length mm	For tube Ø mm
48.420.45	140*	22

* For better fixing and better lever control.

U plate



For ladder hinges.

Code	For tube Ø mm
48.420.50	22

Hinge



For ladders, made of **stainless steel**, supplied without bolts.

Code	For tube Ø mm
48.420.60	22
48.420.61	25

A-frames and T-tops

Foldable A-frame for boats

Made of stainless steel, fitted with upper and side plates for lights and horns.
Telescopic model.

Code	Tube Ø mm	Height cm	Width at fitting point cm	For boats
48.197.00	40	130	125/220	5/7 m



Foldable A-frame for dinghies

Made of stainless steel, very sturdy, fitted with upper and side plates for lights and horns.
Telescopic model.

Code	Tube Ø mm	Height cm	Width at fitting point cm	For boats
48.199.00	40	130	125/180	5/7 m



Jumbo foldable A-frame

50-mm Ø stainless steel tube, fitted with upper and side plates for lights and horns.
Telescopic model.

Code	Tube Ø mm	Height cm	Width at fitting point cm	For boats
48.196.00	50	125	125/220	up to 8 m



A-frame with folding awning

AISI 316

40-mm Ø stainless steel A-frame.
22-mm Ø stainless steel awning.
Rugged UV-resistant awning fabric (for navigation up to 35 knots with open awning).
When not in use, fold the awning against the A-frame, whose upper part can house a navigation light/horn/solar panel.

Code	Mounting width cm	Depth cm	Usable height when open cm	Colour
46.916.01	155	330	120	Blue
46.916.02	165	330	120	Blue
46.916.03	175	330	120	Blue
46.916.04	190	330	120	Blue
46.916.05	210	330	120	Blue



OCEANSOUTH



Seagull aluminium top

32-mm Ø anodized tube construction, extremely rugged. Installation on the central or lateral steering console. The totally adjustable fastening system allows for installation on both sides of the console and on its front; it can also be used on very small consoles. When at rest, it can be **retracted** or **pulled out** of its brackets.

Code	Tube Ø mm	←→ Top	
		Length mm	Width mm
48.195.20	32	135	105
48.195.21	32	150	120
48.195.22	32	150	140

Registered design in EU / Australia / New Zealand



OCEANSOUTH



Targa Top made of aluminium

32-mm Ø anodized tube construction. Universal type for installation on the stringer or on the 25-mm Ø handrail. The Top fabric is made of ATLAS waterproof and UV-resistant blue polyester. Pivoting swing mounts for optimum angle of the four uprights.

Code	Tube Ø mm	←→ Top			Width at base mm
		Length mm	Width mm	Height mm	
48.195.10*	32	172	192	147	190-210
48.195.11	32	172	212	147	210-230

* Navigation at 20 knots is recommended.



Aluminium T-top

32-mm Ø anodized tube. Universal for any type of console since the connections are adjustable. Waterproof and UV-resistant blue ATLAS polyester fabric that can be removed for maintenance. All stainless parts.

Max allowable speed when T-top is installed: 25 knots.

Code	Tube Ø mm	Length A mm	Width B mm	Max width of console A1 mm	Max height C mm
48.194.01	32	1700	1200	850	2050
48.194.02	32	1700	1400	1050	2050



48.194.04 Fishing rod holder for 32-mm Ø tube

48.194.03 Supports for navigation lights.



▲48.194.04

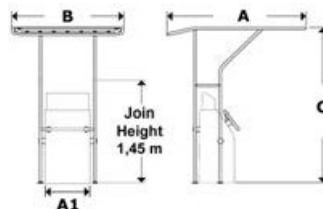

▲48.194.03





Professional aluminium T-top

44-mm Ø tube with high-resistance resin connections and top-quality welded parts. Universal for any type of console since the connections are adjustable. Waterproof and UV-resistant blue ATLAS polyester fabric.

Max. allowable speed when T-top is installed: 25 knots.

Code	Tube Ø mm	Length A mm	Width B mm	Max width of console A1 mm	Max height C mm
48.195.03	44	2000	1400	1000	2000

-  48.195.01 Nylon rod holder for 44-mm Ø pole.
-  48.195.02 Supports for navigation lights.

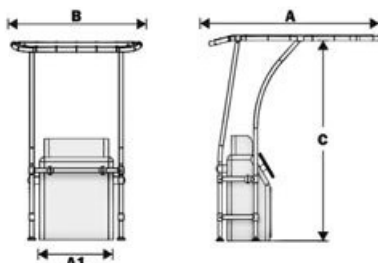

▲ 48.195.01



▲ 48.195.02





Professional aluminium T-top, Heavy Duty version

Made of 44-mm Ø tube with high-resistance resin connections and top-quality welded parts. Universal for any type of console since the connections are adjustable. The T-Top fabric is made of waterproof and UV-resistant blue Atlas polyester.

Max. allowable speed when T-Top is on: 25 knots.

Code	Tube Ø mm	A mm	B mm	Max width of dashboard A1 mm	Max height C mm
48.193.00	44	1400	2000	950	2000

-  48.195.01 Nylon rod holder for 44-mm Ø pipe.
-  48.195.02 Navigation light support.

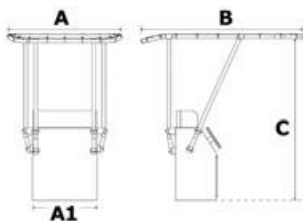

▲ 48.195.01



▲ 48.195.02



Stainless steel T-top

35-mm Ø polished AISI316 stainless steel tube (the cover has 28-mm Ø). Universal model: adjustable width (max. 140 cm) and height (max. 210 cm). Waterproof and UV-resistant blue fabric that can be removed for maintenance. Pull out from the tubes to disassemble the T-top.

Code	Tube Ø mm	Length A mm	Width B mm	Adjustable width D mm		Max height C mm	kg
				min.	max.		
48.195.50	35	2400	1640	500	1400	2100	36
48.195.51*	35	2400	1640	500	1400	2100	39

* Fitted with 4 fishing rod holders



▲ 48.195.51

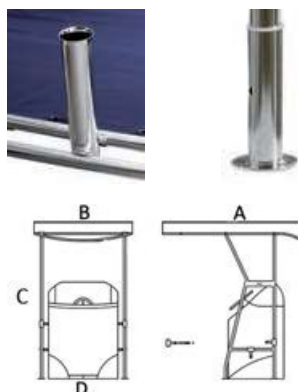

▲ 48.195.50

▲ Fishing rod holder for 48.195.51

OCEANSOUTH



Retractable aluminium T-Top

Designed for laying up and transport on boat trailer. Universal for any type of steering console since the fittings can be adjusted. Blue water- and UV-resistant ATLAS polyester fabric that can be disassembled for service. All stainless parts. Max. allowable speed when T-TOP is on: 25 knots.

Code	Tube Ø mm	Length A mm	Width B mm	Console A1 max width mm	Max height C mm	Retractable height mm	Colour
48.192.01	32	1350	1050	700	2000	1400	Blue
48.192.02	32	1700	1200	850	2000	1400	Blue
48.192.03	32	1700	1400	1050	2000	1400	Blue

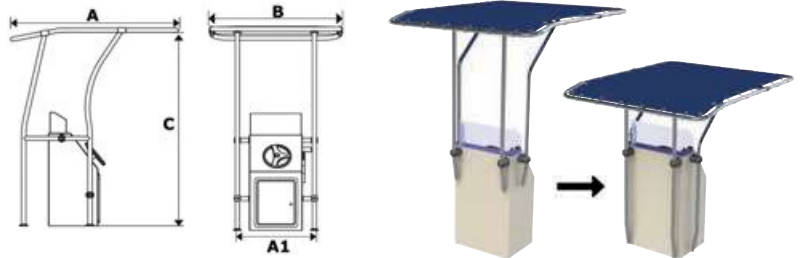

OCEANSOUTH



Accessories for T-Top manufacturing

Description	32-mm Ø hose	44-mm Ø hose
Side fitting	48.180.01	48.180.11
Base	48.180.02	48.180.12
"T"	48.180.03	48.180.13
Pair of radial inserts	48.180.04	-
Blind base	-	48.180.15

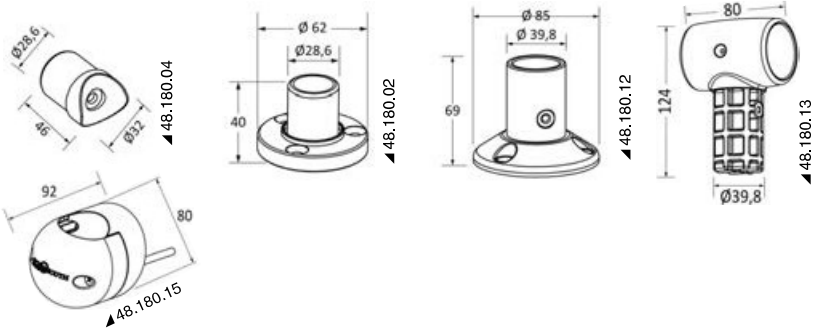

OCEANSOUTH



Universal clear spray hood for T-Tops

Excellent weather-resistant properties. Easy and safe fastening with polyester tapes and buckles. Unobstructed front and side view. Reinforcements in the upper and lower part. Easy to disassemble when not in use.

Code	A mm	B mm	C mm	D mm	E mm	For console max width mm
48.190.02	2630	370	420	1700	1050	700
48.190.03	3030	570	1020	2100	1050	over 700

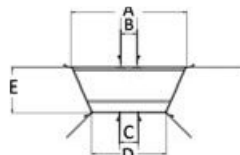

OCEANSOUTH



Full cover for steering console with T-Top

Easy to position, it has to be fastened under the T-Top. It covers both the steering console and the helm seat. Nylon zip closure, elastic tapes around, above and under the seat for tight fit, 260 gr/m² UV-resistant polyester fabric.

Code	Length mm	Width mm	Height mm	Colour
48.189.02	1200	1500	1800	Grey
48.189.03	1200	1830	1800	Grey

Wakeboard Tower and accessories



MTK aluminium watersport tower

For boats longer than 4,80 m and 1,52/2,60-m wide. It is fitted with 360° navigation light (2NM/ COLREG 72). Quick coupling for folding. 64-mm Ø tubes. 5-year warranty. Ready to fit several accessories.

Code	Model	Colour	Original code	bimini OPTIONAL
48.411.01	MTK	Anodized aluminium	SOT405	48.411.11
48.411.02	MTK	Black	SOT407	48.411.11



48.411.01



48.411.02



48.411.11



48.411.02

Bimini top for Monster Tower

Installation in a matter of seconds on the Tower top. Folding model, it doesn't take space on the accessories installed. UV-resistant black Sunbrella® fabric (10-year warranty on the fabric) and anodized aluminium tubes with black accessories.

Code	Description	Colour	cm
48.411.11	Bimini for MTK	Black	183x183



Brackets for wakeboard and water skis

Fitted with a quick coupling system, no tools needed. These brackets can adapt to any tower (for tubes having a different diameter than 64 mm, please order collar kit 48.415.90). Aluminium arms and 303 stainless steel brackets. Rubber protections for the board and the boat. UV-resistant elastic bands to fasten the boards.

Code	Description	Colour	Original code
48.415.31	Bracket for wakeboards with 2 forks for 38 mm	Aluminium	WRBA-2,5
48.415.32	Bracket for wakeboards with 2 forks for 38 mm	Black	WRBA-BK-2,5
48.415.13	Bracket for 2 wakeboards and/or 1 wakeboard + 1 surfboard, with 1 fork for 38 mm and 1 for 70 mm	Aluminium	SWR-2,5
48.415.25	Bracket for 1 Combo ski or 2 Slalom skis with forks for 38 mm	Aluminium	WSR-2,5

48.415.90 OPTIONAL Adapter for 41- to 63-mm Ø tubes.



48.415.31

48.415.13

48.415.25

48.415.32

Watertight LED surface light

IP66

High-efficiency SMD-HD LED light source. Radial base version with soft silicon seal, ideal for booms, A-frames, dinghies, etc.

Code	Finish	LED	LED beam angle	V	W	Lux at 50 cm	Lumen	K	Switch	mm
13.192.20	White	10 SMD-HD	50°	12	3	342	450	4000	Yes	320x40x15

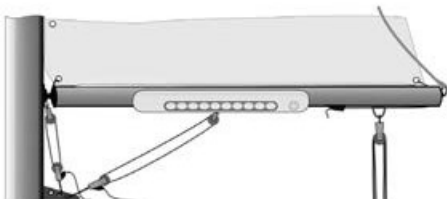

15
40
320

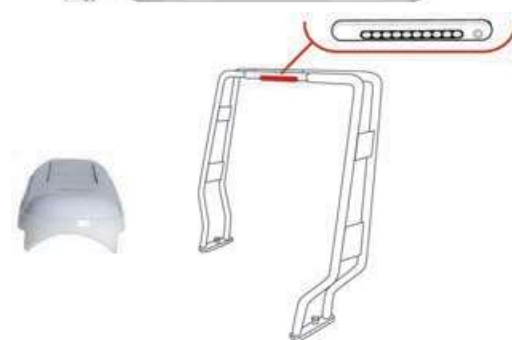

Rear-view mirror for Wake Tower

64.497.00 Large mirror for a perfect view of the skier (18x36 cm). Aluminium bracket, quick release (no tools needed). Mounting on all 41- to 64-mm Ø tubes.



MAGMA barbecues and accessories

MAGMA charcoal barbecue



Made of polished stainless steel. All parts are hinged to keep them from falling into the sea. The lid can be rotated to act as a windscreen.

Code	Model	outer Ø mm
48.511.02	Charcoal	381

MAGMA gas barbecue



Fitted with pressure regulator for CAMPING GAZ aluminium canisters (CV270/470). Made of polished stainless steel, fitted with stainless steel radiant plate. All parts are hinged to keep them from falling into the sea. The lid can be rotated to act as a windscreen.

Code	Model	Outer Ø mm
48.511.01	Gas	381



MAGMA Marine Kettle gas barbecue/burner

Made of polished stainless steel. All parts are hinged to prevent them from falling into the sea. The cover can be rotated to act as a windscreen. Fitted with pressure regulator for CAMPING GAZ aluminium canisters (CV270/470).

Code	Model	Outer Ø mm
48.511.03	Gas barbecue/burner, piezoelectric starting, for CAMPING GAZ canisters	381



MAGMA Adventurer gas grill

48.511.14 100% polished stainless steel. Grilling area: 46x23 cm. Fitted with foldaway legs for use on the ground in picnic areas. Fed by Camping Gaz (CV270/470) canisters.



MAGMA Catalina Infrared barbecue with infrared grilling technology

Polished stainless steel. Designed to use Camping Gaz canisters. Fitted with folding supports for use on the ground in picnic areas. Anti-flame and anti-burst screens integrated in the grilling system for even heat distribution. Electronic ignition, Pressure regulator for CAMPING GAZ aluminium canisters (CV270/470). Piezoelectric ignition + thermometer.

Code	Double cooking grill	
	primary cm	secondary cm
48.511.06	30x46	14x46



MAGMA barbecue mounts 48.511.01/02/03

Code	Description
48.512.01	Barbecue mount for 22/25-mm Ø pulpit tube
48.512.04	Barbecue mount for 28/32-mm Ø pulpit tube
48.512.02	Barbecue mount for the stringer
48.512.03	Barbecue mount for 30/48-mm Ø fishing rod holder
48.512.05	3-leg stand to use the barbecue on the floor
48.512.06	Barbecue mount for flush mounting onto the stringer



MAGMA barbecue cover - round version

Made of sunbrella cordura, it protects the barbecue while in place or stowed.

Code	Colour
48.512.13	 Captain's Navy



Removable serving shelf for barbecue

Made of stainless steel with HD polyethylene top. It hooks to the barbecue and works both as a worktop and serving tray (when unhooked).

Code	mm	For BBQ
48.512.15	440x190	48.511.14; 48.511.06



FDA plastic (HD polyethylene) worktop

Ideal to cut fish or meat, made with odourless, shatter-proof and UV-resistant material, it does not absorb food odours. Fitted with pull-out bayonet stainless steel hinges, designed for mounting on the stringer in a matter of seconds. It comes with kitchen utensil holder.

Code	mm
48.515.00	510x410



FDA plastic (HD polyethylene) worktop, Heavy Duty

Ideal to cut fish or meat. Heavy-duty model fitted with drain and kitchen utensil holder. Made with odourless, shatter-proof and UV-resistant material, it does not absorb food odours.

Code	mm
48.516.00	320x790



MAGMA Party Table

Made of high-density polyethylene, approved by FDA and UV-resistant. It stores bottles of different sizes and turns your worktop into a minibar during onboard parties.

Code	mm	Can fit worktops	Can be mounted with fixing accessories
48.517.00	476x311x100	48.515.00; 48.516.00	48.516.01; 48.516.03; 48.516.04; 48.516.05



MAGMA fastening system for grills and worktops

Code	Description	Grill	For worktops
48.516.01	Mounting on 22/25-mm Ø tubes	48.511.06	48.515.00; 48.516.00
48.516.03	Mounting on 28/32-mm Ø tubes	48.511.06	48.515.00; 48.516.00
48.516.04	Mounting on pull-out (double) worktop	48.511.06/14	48.515.00; 48.516.00
48.516.05	Mounting on the fishing rod holder (single)	48.511.06/14	48.515.00; 48.516.00



48.516.04



48.516.01/03



48.516.05

MAGMA

**MAGMA case**

48.512.12 Made of padded sunbrella cordura, designed for storing MAGMA round grills and their accessories.

MAGMA

**MAGMA spare parts/accessories**

Code	Description
48.512.80	Regulator and valve (10-267-type2) for CAMPING GAZ Cv270/470 canisters
48.512.81	Collar (10-268) for CAMPING GAZ Cv270/470 canisters

Cockpit tables and chairs

OSCULATI

**High-quality tip-top table**

25-mm Ø anodized aluminium frame, 16-mm thick white table top with decoration.

Code	Table top shape	table top cm	Height cm	kg
48.354.02	Rectangular	80x40	61	5.3
48.354.04	Rectangular	88x60	61	7
48.354.06	Rectangular	110x60	70	7.5
48.354.07	Rectangular	130x73	72	11.8
48.354.10	Ovale	95x66	70	8.9
48.354.12	Round	60	40	5.3
48.354.14	Rectangular	60x40	51	6.8



**Anodized aluminium folding padded chair**

25-mm Ø anodized aluminium frame, 6000D polyester padded seat. Stainless steel bolts and screws. Painted wooden armrests.

Code	Model	Fabric colour	cm	
			open	closed
48.352.91	Super-deck	Navy blue	60x43x90 h	90x55x10 h

Anodized aluminium folding chair

25-mm Ø anodized aluminium frame, 600D polyester seat, Stainless steel bolts and screws, polyurethane coated wooden armrests.

Code	Model	Fabric colour	←→ cm	
			open	closed
48.353.01	Beach	 Navy blue	62x57x83 h	89x56x13 h
48.353.05	Deck	 Navy blue	58x71x90 h	89x56x13 h



▲48.353.01



▲48.353.05

Anodized aluminium Director's folding chair



25-mm Ø anodized aluminium frame, sturdy 600D polyester seat.

Code	Model	Fabric colour	←→ cm	
			Open	Folded
48.352.90	Director's chair	 Blue	60x48x79H	17x48x79H



Anodized aluminium Director's folding chair

25-mm Ø anodized aluminium frame. Polished aluminium cast joints. Polyurethane-coated wooden armrests.

Code	Model	Fabric colour	Seat fabric	←→ cm		Max load kg
				open	closed	
48.353.17	Director	 White	White polyester	54x50x87 h	73x55x10 h	120
48.353.18	Director	 Navy blue	White polyester	54x50x87 h	72x52x14 h	120



▲48.353.17



▲48.353.18

Anodized aluminium Captain's chair

25-mm Ø anodized aluminium frame. **White leather fabric** cushions, backrest and armrests padded with soft **polyurethane foam**. Folding for easy stowage.

Code	Colour	←→ cm	
		open	closed
48.340.00	 White	66x76x58 h	65x80x30 h



Kitchenware

Blue Ocean kitchenware

ANTI-SLIP



Plastic kitchenware featuring what follows:

- 1) Anti-slip integrated bottom to ensure stability and dramatically reduce falls and moves.
- 2) Heat-, cold- and humidity-resistant, dishwasher- and freezer-safe.
- 3) Optimum impact resistance and easy to clean.

The kitchenware is made of high-quality food melamine; cups are made of reslyn, a 100% BPA-free thermoplastic material with excellent insulating properties and standing temperatures up to 95°; glasses are made of very bright clear SAN.

Code	Description
48.431.50	All-inclusive set: 6 x plates / soup plates/ dessert plates, 6 x 30-cl glasses, 6 x cups, 1 vassoio

Ancor Line kitchenware

ANTI-SLIP



Plastic kitchenware with the following characteristics:

- 1) Anti-slip silicon bottom for better stability and to prevent falling and movements.
- 2) Heat, cold and humidity resistance for cleaning in the dishwasher and storage in the freezer.
- 3) Excellent resistance to impacts and very easy to clean.

This kitchenware is made of high-quality food-grade melamine.

The set (salad bowl and tray excluded) comes in an elegant display/gift box.

Code	Description	Anti-slip bottom
48.444.01	Set of 6 x plates 25-cm Ø	Yes
48.444.02	Set of 6 x soup plates 22.5-cm Ø	Yes
48.444.03	Set of 6 x dessert plates 20-cm Ø	Yes
48.444.04	Set of 6 x mugs	Yes
48.444.06	Set of 6 x breakfast/fruit/ice cream bowls 15-cm Ø	Yes
48.444.07	Salad bowl 25-cm Ø	Yes
48.444.08	Tray 40x24 cm	No

Ancor Line unbreakable glasses

Made of very bright clear Tritan.
Sold in an elegant display/gift box.



▲ 48.444.12



▲ 48.444.13

Code	Description
48.444.12	Set of 4 x 360-ml water glasses
48.444.13	Set of 4 x 200-ml wine glasses



▲ 48.444.12



▲ 48.444.13



Ancor Line stainless steel cutlery

High-quality stainless steel cutlery with laser-engraved Ancor logo.

Code	Description
48.444.20	24 pcs set (6 coffee spoons + 6 knives + 6 forks + 6 spoons)

Scot gard special synthetic anti-skid tablecloth

It prevents plates and cutlery from falling due to rolling or pitching. The material has a natural cotton look and brings a homely feeling to the table.



Description	Blue	Sand
American set (4 mats + 4 coasters)	48.460.03	48.460.01
Tablecloth to be cut to size 30,5 x 366 cm	48.461.03	48.461.01



Dish Cleaner washing up detergent



Low-foam washing up detergent. Perfect degreasing power, **even** when using **salt water**, it rinses easily. Foam dissipates quickly, avoiding discharging suds into the sea.

Code	Package ml
48.433.05	500 (bottle with dispenser)

YACHTICON Sea Wash



Special concentrated cleaning liquid for dish washing. **It can also be used with salt water** for a considerable saving of fresh water.

Code	Package ml
32.955.00	250

MAGMA Popote nestable cookware

Made of mirror-polished AISI316 stainless steel. For use also on induction burners. Fitted with removable snap handles.



Code	Ø cm	Stacked set height cm	Description	It includes	OPTIONAL
48.700.01	25	18.5	SS inside	4 saucepans, 1 pan, 2 covers, 2 snap handles	48.700.04 colander
48.700.02	25	18.5	Antistick ceramic internal coating	4 saucepans, 1 pan, 2 covers, 2 snap handles	48.700.04 colander



▲48.700.04

Glass and can holders

Plastic universal glass holder for snap-in mounting on pulpits and handrails

Code	Version	For tube Ø mm	Kit includes
48.430.08	Universal	25/30	3 pcs

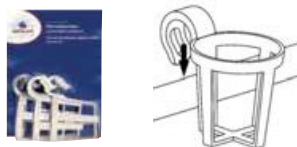

Glass and can holder



Made of **PVC with suction pad** to prevent overturning.

Code	Inner Ø mm	ORDER BY BOX
48.270.10	65	4

Price for 4-pcs set

Glass and can holders



Made of **soft white PVC**, universal size.

Code	Height mm	Ø mm	Mounting base mm	Mounting
48.430.07	100	72	108 x 75	bulkhead

Foldable plastic glass holder



Adjustable frame, bulkhead mounting. For different diameters.

Code	mm
48.430.05	100x95

Foldable glass and can holders



Made of **polished stainless steel**. Adjustable nylon structure to house various glass sizes. Soft plastic foam base. For bulkhead mounting.

Code	mm
48.430.06	107x91x14



Adjustable and folding glass and can holder

100% mirror-polished stainless steel. Finger brackets coated with anti-slip rubber.

Code	Adjustable Ø mm
48.430.04	50 to 79

Anti-vibrating glass holder



Made of **black rubber**, for holding cans or glasses.

Code	Recess Ø mm	Outer Ø mm	Depth mm
48.430.10	75	100	55

Recess fit glass holder

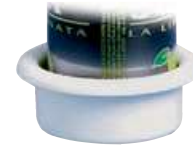

Made of **white ABS**. For holding glasses, cans, bottles or mugs with handle.

Code	Recess Ø mm	Outer Ø mm	Depth mm
48.430.02	75	95	35
48.430.03	90	110	35



▲ 48.430.12



▲ 48.430.13

Recess fit glass holder

Made of ABS.

Code	Colour	Recess Ø mm	Outer Ø mm	Depth mm
48.430.12	Black	75	86	75
48.430.13	White	75	86	75



▲ 48.430.00



▲ 48.430.80

Glass and can holder

Made of moulded polished **stainless steel**, designed for mounting on the control panel or on the driving console.

Code	Colour	Inner Ø mm	Outer Ø mm	Depth mm	Recess Ø mm
48.430.00	Steel	68	88	42	70
48.430.80	Black	68	88	42	70



▲ 48.430.01/11



▲ 48.430.81

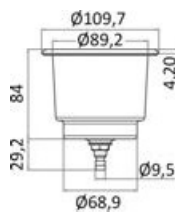

Deluxe stainless steel glass holder

Dual diametre to house bottles and cans. Drain hole with hose adaptor (option). Soft PVC base, mirror-polished edge. Self-adhesive seal for fast mounting and to avoid silicone sealing.

Code	Colour	Type
48.430.01	Inox	Standard
48.430.81	Black	Standard
48.430.11	Inox	12V blue LED internal lighting along the perimeter



Inox Delux Slim steel glass/can holder

Designed to hold bottles and cans: drain hole with hose connector as an option. Soft PVC with logo at the bottom.

Code	Outside Ø mm	Depth mm	Recess Ø mm
48.430.20	87	73	73

Glass holders

AISI 316 Made of mirror-polished AISI316 stainless steel.

Code	No of glasses	Size mm	Height mm	Glass max Ø mm	Mounting
48.429.01	1	106x106	76	90	studs
48.429.11	1	106x106	76	70	screws
48.429.02	2	216x106	76	90	studs
48.429.22	2	216x106	76	70	screws
48.429.03	3	311x106	76	90	studs
48.429.33	3	311x106	76	70	screws
48.429.10	1	106x106	76	90	screws
48.429.04	3	170x170	76	90	studs



Swing-Out glass holder - cup holder - can holder

Made of UV-resistant plastic. It can be opened to take a smaller space. Bulkhead or flat mounting with screws or suction cups (included).

Code	Version	Colour
48.429.80	1 / 2 cups/cans	White
48.429.81	2 / 4 cups/cans	White



Glass holder with suction cup

Suction cup base and glass holder. For bulkhead and flat mounting.

Code	Inner Ø mm	base mm
48.430.14	70	67x70



White plastic object holder compartment

Fitted with suction pads for easy installation.

Code	Description	Fitted with	mm
48.438.51	COCKPIT CADDY - ideal for fishermen and personal objects	3 suction pads	235x120x100 H
48.438.52	GPS/CELL - ideal for GPS or cell phones	2 suction pads	157x74x100 H
48.438.53	CRUISER CADDY - object holder with can holder	3 suction pads	290x130x86 H
48.438.54	LURE ROCK - for fishhooks, baits, knives (31 compartments)	1 snap suction pad	306x58.5x83.1 H



Storage pocket

White ABS body with woven nylon elastic net. **Self-adhesive** back or to be fixed with 4 screws.

White	Black	WxHxD mm	Suitable to be fixed on hatches
48.434.10	48.434.20	250x115x10	20.291.00; 20.293.00; 20.303.00; 20.305.00; 20.305.40
48.434.11	48.434.21	250x115x30	-
48.434.12	-	360x160x12	20.292.00; 20.294.00; 20.299.00; 20.304.00; 20.306.00
48.434.13	-	360x160x30	-



OSCULATI

Storage locker and consoles for dinghies



48.294.91



48.295.01

Storage locker

Made of white VTR, lid fitted with lock.

Code	←→ cm		Ready for seat	Ready for cushion
	base	seat		
48.294.91	80x33x51h	-	-	48.300.10
48.295.01	58x42x38h	54x37	48.415.00	48.300.12
48.296.01	79x42x38h	74x36	48.415.02	48.300.13
48.296.02	90,2x42,2x36,9h	-	48.415.03	48.300.14



48.296.01/02



48.300.13



48.292.02



48.292.04

Helm seat for open boats, with foldable backrest

Made of white fibreglass and fitted with opening seat to be used as a peak. The foldable backrest enables to use the seat facing the bow or the stern. Stainless steel hardware. White leather fabric upholstery.

Code	Type	Length cm	Depth cm	Seat height cm
48.292.02	Jolly 2	90 (two-seater)	48	53
48.292.04	Jolly 4	60 (single-seater)	48	53



Storage locker / seat for 2.30- to 3.30-m dinghies

When the dinghy is 75% inflated, unscrew the side knobs, extend the sides until touching the chambers and finish inflating the dinghy.

Code	Width between vertical bulkheads	Height with cushion cm	Max base width cm	←→ cushion cm	Inside usable compartment cm
48.294.00	adjustable from 62 to 75 cm	31	45	27x62	37x16x23 h



Opening multipurpose peak

Made of white VTR, fitted with stainless steel hinges and chromed brass lever lock. Also suitable as storeroom to be installed on the dock, in front of the boat.

Code	←→ cm
48.297.00	140x50x55h

Steering console



Made of white fibreglass. Fitted with side handrail and front opening peak.

Code	Base cm	Height cm
48.299.00	40x48	81

Steering console with wooden inserts



Made of white fibreglass, fitted with mahogany plywood inserts. Compatible with any wheel steering system. Fitted with stainless steel handrail.

Code	Base cm	Height cm
48.300.00	40x44	81 cm + 9-cm handrail

Bridge 2 steering console



Made of white fibreglass, fitted with stainless steel handrail, plexiglass windscreen, central opening peak.

Code	Type	Length cm	Depth cm	Height (without windscreen) cm
48.298.00	Bridge 2	73	44	104

TV lifts

UP-DOWN TV-LIFT

Vertical electrical lift for TV set. Compatible with VESA 75/100/200 fastening systems. Black coated or anodized elements. 22- to 25-mm/s approx. speed depending on the TV set weight. A 6-pole switch is needed to reverse polarity (14.192.03 or 48.749.01).

Code	V	Inner height A mm	Outer height B mm	Stroke C mm	Width D mm	Thickness E mm	TV set max height F mm
48.760.12	12	650	1165	515	300	58	500
48.761.12	12	700	1265	565	300	58	550
48.761.24	24	700	1265	565	300	58	550
48.762.12	12	750	1365	615	300	58	600
48.762.24	24	750	1365	615	300	58	600

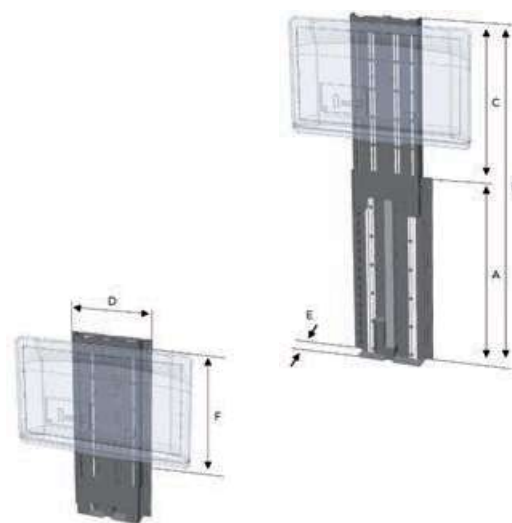

Bed base for berths

Elastic base for beds/berths

Made of flexible wood bent slats joined together by means of special anti-slip and mouldable plastic tapes that follow the bed shape. The elastic base has 2 functions:

- 1) aeration of the bed to avoid mould and humidity
- 2) excellent comfort of the bed.

Supplied in single-bed kit (for double bed, use 2 kits).

The wooden slats can be cut according to the desired perimeter and are then assembled using the flexible tapes.

Code	Bed base made of	mm
48.790.01	16 x 100x62x8-mm staves + 2 x 2000-mm side tapes	2000x1000 (trimmable)

For the double bed, use 2 pcs.

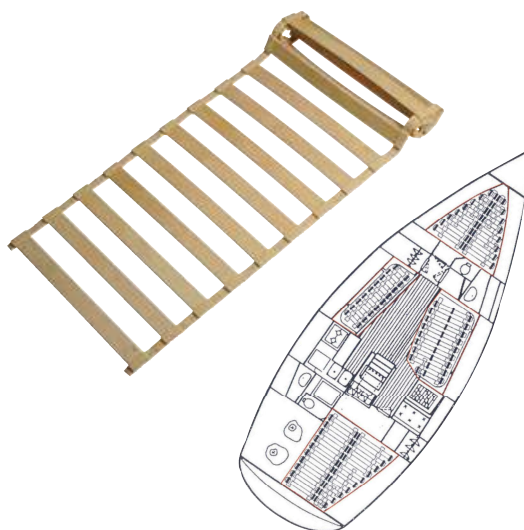

BEDFLEX® elastic bed base for beds and berths

Made with beech multilayer slats with 5 (8-mm) or 6 (10-mm) unidirectional coatings for better elasticity.

The slats are kept together with a synthetic rubber tape. No humidity or mould under the bed. Cut the slats with a hacksaw to adapt them to any shape.

Code	Description	mm	Thickness mm	No. of tapes
48.792.01	14 slats (single)	90x200	8	2
48.792.02	14 slats (double)	140x200	8	3
48.793.01	14 slats (double)	160x200	10	3
48.793.02	14 slats (double)	180x200	10	3

