

## AISI 316 stainless steel tent accessories

### Bimini accessories



#### AISI 316

Made of mirror polished AISI316 stainless steel.

Description	For pipes Ø mm				
	20	22	25	25 (Heavy Duty)	30
	6-mm pin/bore		8-mm pin/bore		
Internal end cap	-	46.659.95	-	-	-
End cap	46.660.00	46.661.01	46.861.03	46.122.21	46.761.03
Raised end cap	-	46.661.05	46.861.02	-	-
Fork joint	46.660.01	46.661.00	46.861.02	46.122.11	46.761.02
Bent fork joint	46.662.22	46.662.22	46.662.22	-	-
90° fork joint	46.861.04	46.861.04	46.861.04	46.516.00	46.516.00
90° fork joint with removable spring pin	46.662.20	46.662.20	46.662.20	-	-
Bent fork joint with removable spring pin	46.662.21	46.662.21	46.662.21	-	-
Concave base for support for 20- to 25-mm Ø pipes	46.563.00	46.563.00	46.563.00	-	-
Concave base for support for 20- to 25-mm Ø pipes and removable spring pin	46.862.00	46.862.00	46.862.00	-	-
Concave base for support for 40-mm Ø pipes and removable spring pin	46.863.00*	46.863.00*	46.863.00*	-	-
43x51 mm bulkhead mount support	46.403.00	46.403.00	46.403.00	-	-
48x73 mm bulkhead mount support	46.404.01	46.404.01	46.404.01	46.404.00	46.404.00
Fixing base for hoods with 62x25-mm 40° wing slope	46.659.00	46.659.00	46.659.00	-	-

\* To be mounted on 40-mm Ø tubes.



### Reinforced joints with double setscrew

#### AISI 316

Mirror-polished AISI 316 stainless steel.

Description	For hose Ømm		
	22	25	30
	6-mm pin/bore		5,5-mm pin/bore
End cap	46.685.22	46.685.25	46.685.30
Fork joint	46.686.22	46.686.25	46.686.30

**STREAM LINE joints for awnings**

**AISI 316** Made of mirror polished AISI 316 stainless steel, new faired version, 6-mm pin/bore.

removable snap fork**	Base with		End cap	Swivel with ear	For tubes Ø mm
	removable snap ear*	ear*			
-	-	-	46.650.22	46.651.22	22
46.654.22	46.653.22	46.652.22	-	-	22/25
-	-	-	46.650.25	46.651.25	25

\* 46.650.22/25 Terminal caps *OPTION*  
 \*\* 46.600.00;46.661.01; 46.861.03; 46.761.03 Awning caps *OPTION*

**OSCULATI**



**Range of bimini fixing components with ball joints**

**AISI 316** Nylon rotation seat; the two parts can be separated quickly by slipping off the special safety pin; made of mirror polished AISI 316 stainless steel.

Code	Description	For tubes Ø mm
46.680.00	93x40-mm flat base	-
46.680.10	Openable base for mounting on tube	25
46.680.20	90° cap	25
46.680.21	Straight cap	25



**OSCULATI**



**Telescopic pole for perfect bimini tension**

**AISI 316** Made of mirror polished AISI 316 stainless steel; allows the user to put erect the awning to the perfect tension every time **without dismantling**.

Code	For pipes Ø mm	Length when closed mm	Stroke mm	Bore Ø mm
46.800.22	22	135	30	6
46.800.25	25	135	30	6
46.800.30	30	144	32	6

**OSCULATI**



**Terminal caps**

**AISI 316** Suitable for adjustable eye hood pipes and with 15 mm travel; adjusts the awning perfectly; made of mirror polished AISI 316 stainless steel.

Code	For pipes Ø mm	Bore Ø mm
46.700.22	22	6
46.700.25	25	6
46.700.30	30	6

**OSCULATI**



**Fork joints for 3-arc frame**

**AISI 316** Made of mirror-polished AISI 316 stainless steel. These joints are designed for large 3-arc frame biminis.

Code	Hose Ø mm	Centre distance A mm	Ref. cap
46.761.02	30	40	46.761.03
46.761.05	30	73	46.761.03
46.761.06	30	113	46.761.03



**Internal 90° swivelling joints**

**OSCULATI**

**AISI 316**



For hood pipes; made of mirror polished AISI 316 stainless steel.

Code	For pipe Ø mm
46.320.12	20x1,2
46.322.12	22x1,2
46.320.15	20x1,5
46.322.15	22x1,5

**90° external swivelling joints**

**AISI 316**



Suitable for awning pipes, made of mirror polished AISI 316 stainless steel.

Code	For pipe Ø mm
46.330.22	22
46.330.25	25

**90° external joint with lock**

**AISI 316**



Suitable for awning pipes, made of mirror polished AISI 316 stainless steel, fitted with locking pin.

Code	For pipe Ø mm
46.330.30	30

**OSCULATI**



**180° articulated joint for bimini tops**

**AISI 316**

Made of mirror-polished AISI 316 stainless steel, high-resistance version for large bimini tops with 25/30-mm tube frame

Code	Base mm	Pin mm
46.667.00	106x42	8

**Swivelling 180° hood junction**

**AISI 316**



Made of **AISI 316 stainless steel**, includes plastic base.

Code	Length mm	With screw mm
46.665.00	70	6

37.264.10 *Pin INCLUDED*

**Awning base**

**OSCULATI**

**AISI 316**



Made of **AISI 316 stainless steel**, fitted with retrievable fork pin.

Code	Base mm	For tubes Ø mm	Pin mm
46.670.00	90x40	22/25	6

**OSCULATI**



**Snap base for biminis or awnings**

**AISI 316**

Snap hooking system.

Code	Description	For tube Ø mm	Pin mm
46.670.10	90x40-mm external base	22/25	6
46.670.20	54x29-mm recess fit base	22/25	6



**Fork**

**AISI 316**

Made of **polished AISI 316 stainless steel**, suitable for awning gunwale-mounting on dinghies.

Code	Pivot Ø mm
46.662.00	12x23



**Hood sleeve coupling**

**AISI 316**

Made of mirror-polished **AISI 316 stainless steel**.

For tubes Ø mm	With lock pin	With spring lock	Length mm	Screw / pin mm
22	46.978.00	46.978.01	73.5	6
25	46.978.10	46.978.11	75.7	6
30	46.978.20	46.978.21	85	6



**Bimini sliding bracket**

**AISI 316**

Made of mirror polished AISI 316 stainless steel, fitted with cam quick clamping system.

Code	For tubes Ø mm	Pin mm
46.978.50	22	6
46.978.51	25	6



**Sliding awning clamps**

Enables for the hood to slide back and forth, made of **chromed brass** and fitted with **stainless steel screws**.

Code	Mounting on tube Ø mm	Pin mm
46.185.22	20/22/25	5

**Connectors for Bimini poles**

It combines two Ø 22/25-mm tubes without weld, or makes them telescopic by fitting one into the other. Mirror-polished AISI 316 stainless steel.

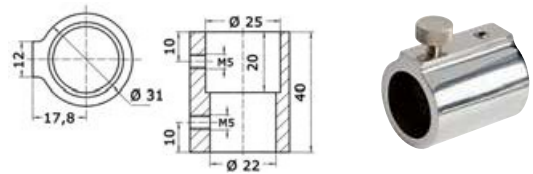

Code	For hoses Ø mm
46.658.00	22/25

**Straight line pole connectors, fitted with two spring lock buttons**

To be mounted inside the pipe. Mirror polished AISI 316 stainless steel.

Code	Length mm	For pipe Ø mm
48.420.36	150	22x1.2
48.420.37	150	25x1.2

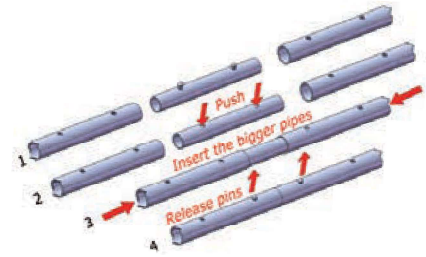

**Stay kit for for spray hood or bimini**

Mirror polished AISI 316 stainless steel

Code	Ø hose mm	Kit components
46.657.22	22	cm 100x2 hose Ø 22 41,613,01 + 4 pcs 46,661,01 + 2 pcs 46,661,00 + 2 pcs 46,662,20
46.657.25	25	cm 100x2 hose Ø 25 41,618,01 + 4 pcs 46,861,03 + 2 pcs 46,861,02 + 2 pcs 46,662,20



**Telescopic stays for biminis (pair)**

Made of Ø 22/25-mm mirror-polished stainless steel, they support the tent rear side.

Code	Hose Ø mm	Travel cm	Kit contains
46.656.00	22/25	75/120	46,661,01 (2) + 46,861,03 (2) + 46,662,20 (2) + 46,661,00 (2) + 46,658,00 (2) + 41,618,00 120 cm (60x2) + 41,613,00 120 cm (60x2)



Installation type

**Stainless steel plate Ø size 6 mm + stainless steel cable Ø size 1.6 mm + stainless steel pin**



Used to remove boat hoods, suitable for all of our hood fork supports.

Code	Version
46.116.30	Version with spring ball locking pin (series 37,264,xx)
46.116.29	Version with spring folding pin (46.116.31)

**Drop nose pin**



Made of **stainless steel**, suitable for U-bolts hood supports, with spring loaded locking mechanism.

Code	Ø mm	Operating length mm
46.116.31	6	20

**Traveller system for awnings / spray hoods**

**AISI 316**

100% AISI 316 stainless steel. Made of a 2-pc rail that fully hides the fixing screws. The different types of support are installed on a stainless steel traveller whose stop has a 15-mm pitch.

Code	Description	Pin / bore mm
46.673.00	30x1200-mm rail	-
46.673.02	Terminal for rail (order 2 pcs per rail)	-
46.673.05	Traveller with fork joint 46,662,20	6
46.673.06	High-resistance traveller. 180° articulation, for large bimini tops with 25/30-mm tubes frame	8

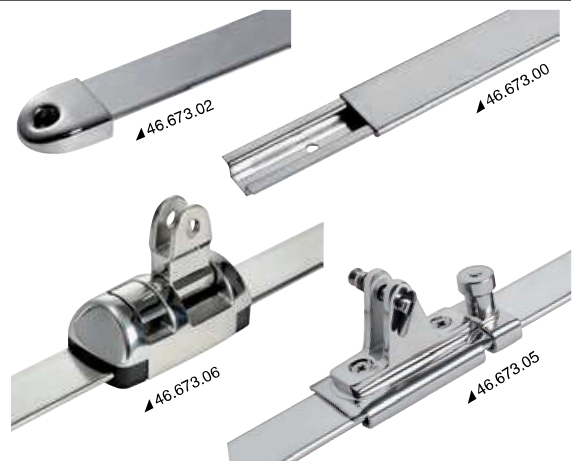



**LEWMAR ball traveller for awnings/spray hoods and sliding doors**

Specially designed for this purpose it is made of anodized aluminium with Delrin balls, saving profile and flat holding surface with 2 M6 threaded holes.

Code	Description	Width mm	Length mm	Height mm	Hole centre distance mm	Working load kg
46.674.01	traveller	51	124	26	35	450
46.674.30	track	19	2986	11	80	-
46.674.40	end stop	51	20	-	-	-



**Ball bearing travellers for sliding roofs and sliding doors**

Made of heavy **anodized aluminium** with PTFE ball bearing, assure excellent swivelling movement even under high loads; fitted with two 5 MA threaded holes. Suitable for travellers 62.940.08.

Code	width mm	Projection mm	Length mm	Max working load kg
46.675.01	51	20	83	220
46.675.03	51	20	105	260



62.940.08 Rail mm 19x13,4, 2 metre bars (4 metres on demand), In light anodized alloy.



62.940.09 Rail nylon terminal end 62.940.08

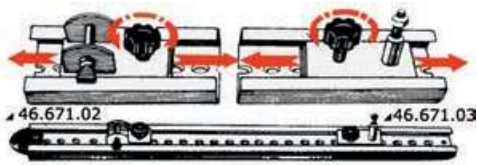

**Traveller sliding system for awnings**

The system is made up of:

Code	Description
46.671.01	End in <b>plastic</b> for rail
46.671.02*	Sliding plate in <b>stainless steel</b> with screw lock and "U" hinge
46.671.03*	Sliding plate in <b>stainless steel</b> with pivot lock for wall mounting

\* Suitable for fixing hoods; universal model, suitable for surface mounting.



**Awning slider**

Made of **anodized aluminium**; swivelling fork joint suitable for working on a **flat surface** and on the **wall**. Spring lock for fast movement, internal **nylon** slides to provide a perfect sliding movement, quick awning mounting pin.

Code	Version
46.669.00	85x35x35-mm slider (overhang) with 6-mm pin
61.591.01	25x4-mm <b>aluminium</b> rail for slider 46.669.00 (2-m bars)
61.591.43	<b>Black nylon</b> terminal for 61.591.01

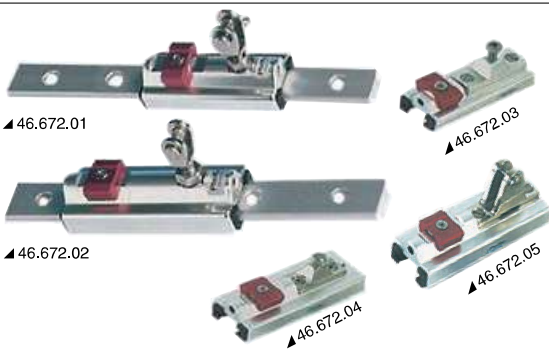

**Adjustable sliding travellers suitable for hull awning sizes from 10 meters or higher**

Made of **anodized aluminium**, fitted with **stainless steel** awning bracket and internal nylon slide, antifriction and noise-proof (track to be ordered separately).

Code	Description	Pin / bore mm
46.672.01	Fork bracket for 25x4-mm track (art. 61.591.01)	6
46.672.02	Fork bracket for 32x6-mm track (art. 61.591.02)	8
46.672.03	Bulkhead mount bracket for 25x4-mm track (art. 61.591.01)	-
46.672.04	Bulkhead mount bracket for 32x6-mm track (art. 61.591.02)	-
46.672.05	Fork fixed bracket for 25x4-mm track (art. 61.591.01)	6



**Turnbuckle for awning ropes**

Made of polished stainless steel, it adjust the fastening ropes of awnings.

Code	mm
46.377.40	55x12

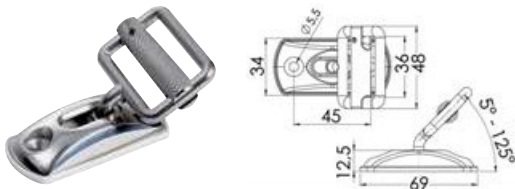

**Buckle for tapes**

**AISI 316**

Made of polished AISI 316 stainless steel, with **removable** and 5° to 125° **balancing** buckle.

Code	For tapes max mm	Base mm	Hole centres mm
46.670.60	30	69x34	45

**Bimini base with EPDM support for inflatables**

The EPDM support is designed to be stuck on the inflatable chambers.

Code	Type	Material	Support colour	For tube Ø mm	Support mm	SS base used
46.670.30	Base and support	EPDM + SS	Light grey RAL 7035	22/25	188x135	46.670.00
46.670.40	Base and support	EPDM + SS	Light grey RAL 7035	22/25	188x135	46.670.10



**Bimini top tensioning strap kit**

It includes a 25-mm wide and 3-m long tape (2,90-m usable length). Snap hook and strap on one end for fixed adjustment, snap hook on the other end for tensioning. Sold in pairs in display package.

Code	cm	Package
46.677.00	2.5 x 300	2 pcs

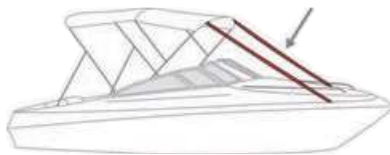

**Plastic bimini accessories**

**Made of nylon, suitable for pipe Ø size 20mm**



Code	Description	ORDER BY BOX
46.629.00	90° articulated joint	1 pcs
46.630.00	170° articulated joint	Pair
46.631.00	Nylon pin	1 pcs
46.632.00	Nylon base	1 pcs
46.633.00	Nylon rowlock socket	1 pcs

**Fitting for 22-mm Ø tube.**



Code	Description	Pin / bore mm
46.377.03	Sliding joint and clamps	6
46.377.13	End cap	6
46.377.21	Side plate	6
46.377.31	Fork base	6

**Spare components for bimini tops**

Made of white nylon

Code	Description	Tube Ø mm	Reference bimini top
46.625.02	Hose terminal	22	46.908.xx; 46.909.xx; 46.918.xx
46.625.03	Rowlock	-	46.908.xx; 46.909.xx; 46.918.xx
46.625.04	Bushing	-	46.908.xx; 46.909.xx; 46.918.xx
46.625.05	Bend articulation	22	46.908.xx; 46.909.xx; 46.918.xx
46.625.06	Arm articulation	22	46.908.xx; 46.909.xx; 46.918.xx



**Anodized aluminium bimini accessories**

**Suitable for tubes Ø 20 mm**

Code	Descrizione
46.931.00	Eye terminal
46.932.00	Clamp joint
46.933.00	Plate to be fixed with 2 screws and a "U" bolt
46.934.00	Wall mounting bracket, stainless steel
46.787.20	Hinge for bracket



**Aluminium travellers for nylon sliders**

Suitable to slide and shift the boat awning foot.

Code	Bars m	mm
46.786.03	1	22x11

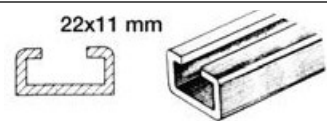

Code	Description
46.786.10	Nylon plate sliding in track to fasten plate 46.934.00 or 46.933.00
46.786.20	Nylon stop to lock tent in preset position
46.786.30	Nylon track terminal



## Folding BIMINI with anodized aluminium structure



### 2-arch bimini top

Reinforced anodized aluminium tubes, **22-mm Ø tube**. Cover made of **waterproof and UV-resistant 600D polyester/polyurethane fabric**. It comes in a case to protect the fabric during stowage.

White	Navy blue	Width A cm	Width B cm	Height C cm	Depth cm
46.901.21	46.901.31	118	130/140	110	180
46.901.22	46.901.32	138	150/150	110	180
46.901.23	46.901.33	163	175/185	110	180

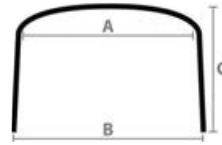

### 3 arch bimini top

Anodized aluminium frame, **22-mm Ø tube**. Cover made of waterproof and UV-resistant 600D polyester/polyurethane fabric. It comes in a zipped case to protect the fabric when the bimini top is closed.

White	Navy blue	Width A cm	Width B cm	Height C cm	Depth cm
46.908.20	46.908.30	138	150/160	110	180
46.908.21	46.908.31	158	170/180	110	180
46.908.22	46.908.32	173	185/195	110	180
46.908.23	46.908.33	188	200/210	110	180
46.908.24	46.908.34	208	220/230	110	180

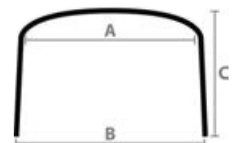

### 3-arch folding bimini top, tall version

Anodized aluminium frame, **22-mm Ø tube**. Cover made of waterproof and UV-resistant 600D polyester/polyurethane fabric. It comes in a zipped case to protect the fabric when the bimini top is closed.

White	Navy blue	Width A cm	Width B cm	Height C cm	Depth cm
46.909.40	46.909.50	138	150/160	140	180
46.909.41	46.909.51	158	170/180	140	180
46.909.42	46.909.52	173	185/195	140	180
46.909.43	46.909.53	188	200/210	140	180
46.909.44	46.909.54	208	220/230	140	180

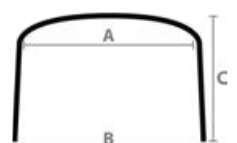

### BIMINI DEPTH 4-arch sunshade

Anodized aluminium structure, **22-mm Ø tube**. 600D polyester/polyurethane fabric, waterproof and UV-resistant. It comes in a zipped case to protect the fabric when the Bimini Top is closed.

White	Navy blue	Width A cm	Width B cm	Height cm	Depth cm
46.918.02	46.918.12	163	175/185	140	250
46.918.04	46.918.14	178	190/200	140	250
46.918.06	46.918.16	193	205/215	140	250
46.918.08	46.918.18	208	220/230	140	250
46.918.10	46.918.20	223	235/245	140	250

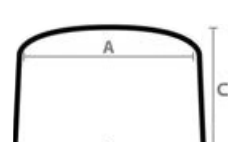

## Foldable biminis with AISI 316 stainless steel frame

### SHADE MASTER FLY INOX DEPTH 4-arch folding bimini top

**AISI 316** Fitted with 25-mm Ø tubes and AISI 316 stainless steel joints. Foldable frames, **waterproof and UV-resistant** polyester/PVC fabric, **blue navy** colour. Case included. Foldable and removable. Made in Italy.

Code	Width B cm	Height cm	Depth cm
46.915.10	180/190	140	255
46.915.11	200/210	140	255
46.915.12	220/230	140	255
46.915.13	240/250	140	255
46.915.14	260/270	140	255

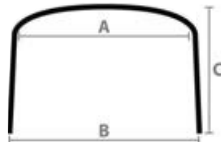

### 3-arch Bimini

Made of polished AISI316 stainless steel 25-mm Ø tube, AISI316 stainless steel fittings. Foldable arches, **Waterproof and UV-resistant** 600D polyester/polyurethane fabric.

White	Navy blue	Width A cm	Width B cm	Height cm	Depth cm
46.920.02	46.920.12	158	170/180	140	180
46.920.03	46.920.13	173	185/195	140	180
46.920.04	46.920.14	188	200/210	140	180
46.920.05	46.920.15	203	215/225	140	180
46.920.06	46.920.16	233	245/255	140	180



▲ Mounting kit included

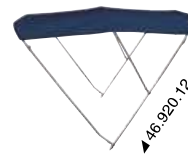
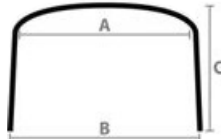

### BIMINI DEPTH high 4-arch sunshade

Made of 25-mm Ø polished AISI316 stainless steel tube, AISI316 stainless steel fittings. Folding arches, **UV-resistant and waterproof** 600D polyester/polyurethane fabric. It can be disassembled and folded away into its case.

White	Navy blue	Width A cm	Width B cm	Height cm	Depth cm
46.921.10	46.921.20	168	180/190	140	250
46.921.11	46.921.21	188	200/210	140	250
46.921.12	46.921.22	208	220/230	140	250
46.921.13	46.921.23	228	240/250	140	250
46.921.14	46.921.24	248	260/270	140	250



▲ Mounting screws, included

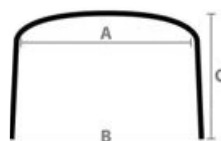



## TESSILMARE folding biminis

### TESSILMARE



#### TESSILMARE Shade Master biminis suitable for high speed boats

fixed installation not required; **foldable and made of white painted aluminium pipes**, 20-mm Ø, white; waterproof, UV-resistant **polyester/PVC fabric**. Case included. Nylon joints.

Code	Depth cm	Height cm	Width cm	Bracket cm	Frame
46.902.01*	180	110	124/140	144	2
46.902.02	180	110	140/160	144	3
46.902.03	180	110	160/180	144	3
46.902.04	180	110	185/215	144	3
46.902.05	180	140	215/235	173	3

\* Model fitted with 2 archs instead of 3.

### TESSILMARE



#### TESSILMARE "Shade Master HS" bimini, designed for high speed boats

Does not require fixed installation; **foldable with white painted aluminium pipes**, 25-mm Ø, white **waterproof UV-resistant polyester/PVC fabric**. Case included. AISI 316 stainless steel joints.

Code	Depth cm	Height cm	Width cm	Bracket cm	Frame
46.901.53	195	95	160/180	143	2
46.901.54	200	110	190/210	147	2
46.901.55	215	120	215/225	156	2

### TESSILMARE



#### TESSILMARE "Shade Master Fish" bimini specially designed for open hulls with pedestal steering

##### PATENT

Aluminium frame, 20-mm Ø, white coating, fitted with four foldable arches, sturdy **PVC polyester fabric**. It includes case for storage (folded) and nylon joints.

white	beige	Depth cm	Height cm	Width cm	Bracket cm	Arches
46.914.01	-	180	140	140/160	160	3
46.914.02	46.914.32	180	140	160/180	160	3
46.914.03	46.914.33	180	140	190/210	160	3
46.914.04*	-	240	140	210/230	200	4

\* This tent is also ideal for cabin **Flying Bridges**. Made with 25-mm Ø tube, **nylon joints**, sturdier fabric, fixed flat joint, nylon/stainless steel, **special case**. 4 x foldable arches.



### TESSILMARE



#### TESSILMARE Shade Master SS detachable bimini

##### AISI 316

Fitted with pole Ø size 22 mm and all **AISI 316 stainless steel fittings**. Fixed and foldable arcs, white waterproof UV-resistant **polyester/PVC fabric**, **adjustable stainless steel supports** swivelling at 90°. Case included.

##### PATENT

white	Depth cm	Height cm	Width cm	Folded bracket cm	Arches
46.915.02	180	151	165/175	180	3
46.915.03	180	151	180/190	180	3
46.915.04	180	151	195/205	180	3
46.915.05	180	151	225/235	180	3
46.915.06	220	151	240/250	180	3



## Mickey self-tensioning, modular and independent Bimini system



It can be used as sunshade or water protection and is UV-resistant. Simple to assemble, disassemble and store. It can be installed in many different ways. The 15°-inclination basis are small and can be easily in different places of the deck depending on the needs and provide a wider coverage than traditional systems.

Much more convenient than the standard systems available on the market (canopy not included).

### New Flexible pole for Mickey system

Fiberglass pole covered in **carbon fibre** with AISI316L stainless steel inserts.

Code	Ø mm	Overall height A cm	Distance gained with slope B cm	Net height from flush deck C cm	Recess D cm
46.826.14	16	137	34	129	8
46.826.15	16	153.5	38	145	8
46.826.17	16	170	43	160	8
46.826.18	16	185	47	175	8

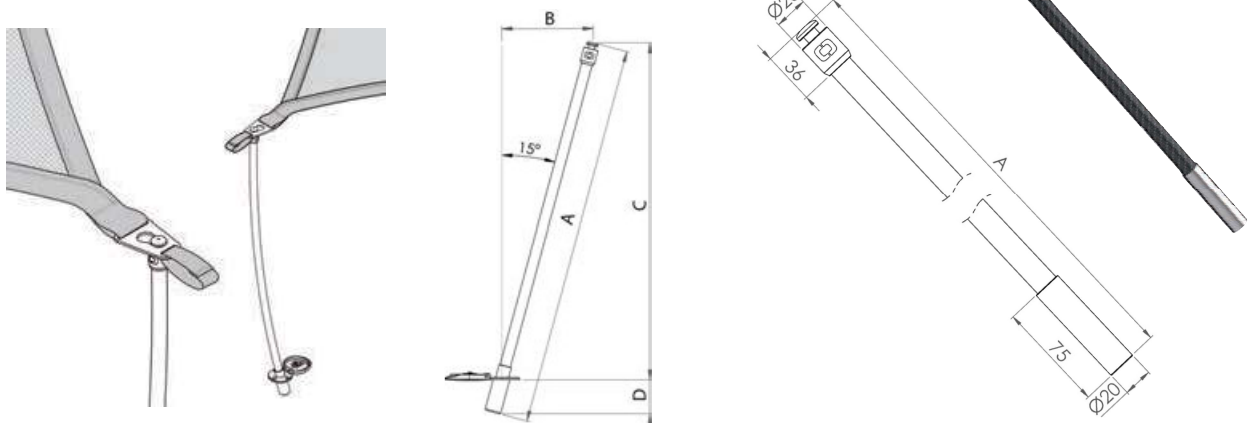

### New Stainless steel fastening bushing for Mickey system

Recess-fit AISI316 stainless steel bushing with fastening counter-ring. Available in 3 models.

Code	Description	For poles Ø mm	←→  mm					min/max deck thickness F mm
			Ø A	B	Ø C	Ø D	E	
46.825.00	No lid	16	52	40	54	4	26	8/40
46.825.01	Rotary lid	16	58	58	54	5	26	2/50
46.825.02	Watertight lid	16	69	62	54	10	26	2/50

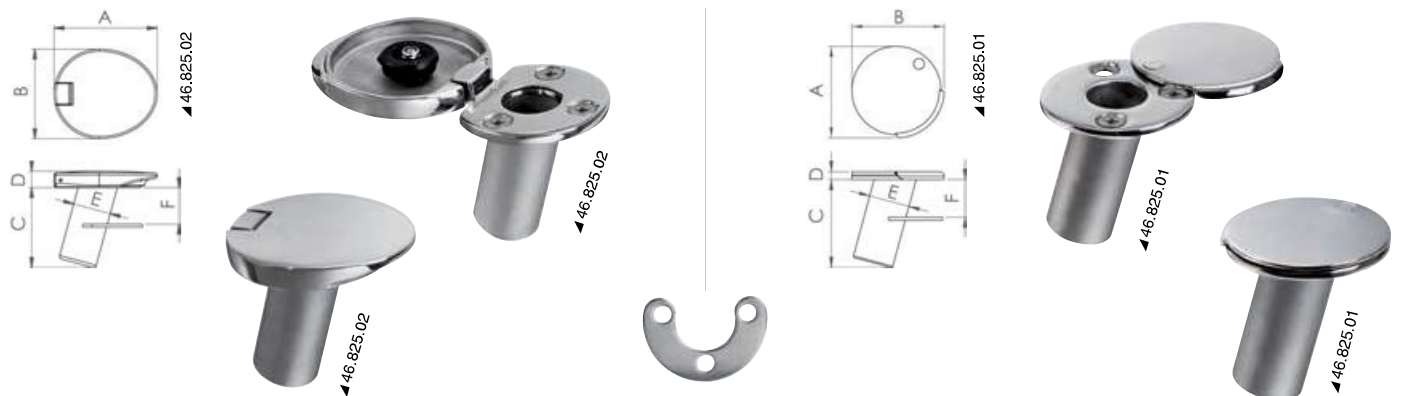

### New Fastening buckle for Mickey system

AISI316 stainless steel buckle for a simpler fastening of the Bimini top to the pole.

Code	←→  mm		←→  buckle slot mm	
	A	B	1	2
46.825.09	74	50	40x5	20x3



## Bimini top with carbon tubes

**OSCULATI**

Bimini top modular system. High finish with mirror-polished swivel-lock bushings.

**OSCULATI**

### Carbon pole for Bimini top

The pole rotates by 90° inside the bushing and locks. The poles are fitted with tightening bushings. Clamcleat for easy adjustment and tensioning of the Bimini top already mounted on the pole. Compatible with recess-fit bushings 46.815.xx and 46.280.xx. Fastening rope: eye spliced Dyneema rope. It can be used for direct installation on the Bimini top by means of a 10-mm Ø pawl or a snap hook. Rope not included with the pole.

▲ Maxi fastening bushing



Code	Ø mm	Height cm	Bulkhead stowage system OPTIONAL
46.816.02	38	130	34.358.38
46.816.04	38	150	34.358.38
46.816.06	38	170	34.358.38
46.816.07	New	185	34.358.38
46.816.08	38	200	34.358.38
46.816.10	38	230	34.358.38
46.821.02	50	170	34.358.50
46.821.04	50	200	34.358.50
46.821.06	50	230	34.358.50

46.817.00 MARLOW spliced line, length 130 cm with 50 cm adjustment



**Removable carbon pole for Bimini top**

**2 PCS MOUNT POLE**

The pole is made up of two section and is fitted with anticorodal aluminium bushings for fast mounting. Tightening bushings and a fastening line are also supplied. The pole rotates by 90° inside the bushing and locks.

A clamcleat already mounted on the pole allows for an easy adjustment and tensioning of the Bimini top.

Compatible with recess-mount bushings 46.815.00/01, the bulkhead mount bushing kit 46.815.10 and the bulkhead mount stowage system 34.358.38.

Fastening line made of spliced Dyneema with eye. It can be used for direct fastening to the Bimini top with a 10-mm Ø ball or a shackle.

Code	Ø mm	Height cm	No of sections
46.818.09	38	90/181	2
46.818.11	38	110/231	2

46.817.00 MARLOW 130-cm long spliced line for 50-cm usable adjustment

34.358.38 Bulkhead stowage system

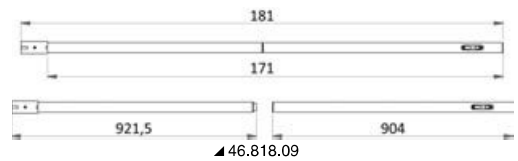
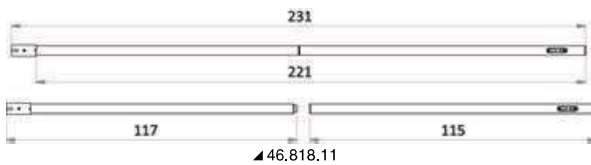

**Recess-fit bushing for 38- and 50-mm Ø carbon pole**

Made of stainless steel, fitted with 180° swivel lock. Arranged for 12-mm Ø water drain hose. Lock protection for the cup when not in use. The lock can be customized with a logo upon request.

Code	Pole-Ø mm	Description	mm			
			Ø A	B	Ø C	Ø D
46.815.00	38	Recess-fit bushing, straight	95	141.5	56	74
46.815.01	38	Recess-fit bushing, inclined at 6°	95	141.5	56	74
46.815.90	38	Mounting counterflange for recess-fit bushing	95	-	-	74
46.820.00	50	Recess-fit bushing, straight	108	150	70	90
46.820.01	50	Recess-fit bushing, inclined at 6°	108	150	70	90

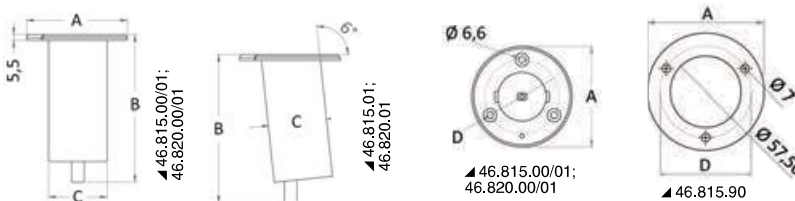

**OSCULATI**



**Bushing for wall mounting for 38-mm Ø carbon pole**

Upper and lower wall-mounting support for the bimini pole. The pole rotates by 90° inside that support and locks in position. High quality finish system with mirror-polished surface and front logo.

Wall mounting by means of two conical screws (M6x40 or longer). Blind lower support, through upper support.

Code	Pole-Ø mm	Description	mm			
			A	B	C	D
46.815.10	38	Bush kit for wall mounting	92	106	65	74

**OSCULATI**

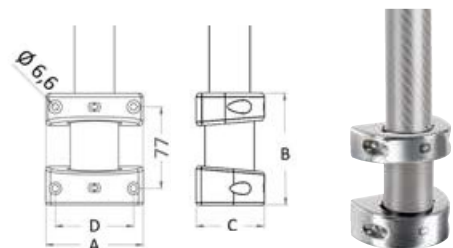

**Bushing for fixing on tubes for 38-mm Ø carbon pole**

Double support to fix the pole to the stanchion.

The bushings are made of stainless steel and are fastened to the stanchion with a counterflange and two M6 screws.

Blind lower support, through upper support.

Code	For poles Ø mm	Description	For tubes Ø mm	mm			
				A	B	C	D
46.815.12	38	Bushing kit for stanchion	25/30	62	115	31	48

**OSCULATI**

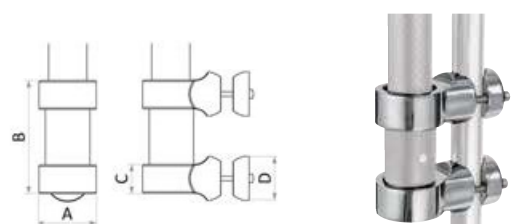

## Awnings and equipment covers

### Parasol folding sun umbrella, for boats

Anodized aluminium metal parts. Fiberglass tube frame, UV-resistant polyester cover. 45° tilting mechanism. Fitted with rubber resting base, fastening straps and carrying bag.

Code	Colour	cm			kg
		open	folded	max height	
46.891.01	White	200x200	13x13x165	265	4,8
46.891.02	Blue	200x200	13x13x165	265	4,8
46.891.03	Grey	200x200	13x13x165	265	4,8



### Stainless steel or fiberglass tube telescopic awning for roll-bar

**AISI 316**

Universal mounting to the roll-bar, made of waterproof fabric with AISI 316 stainless steel tube structure.

Bimini top	white	Navy blue	A cm	B cm	C cm	D cm	E* cm
Front	46.906.01	46.906.11	120	145	190	145/155	120x35
Front	46.906.02	46.906.12	130	150	190	160/170	130x35
Front	46.906.03	46.906.13	130	170	190	175/185	130x35
Front	46.906.04	46.906.14	130	190	190	195/205	130x35
Rear	46.906.21	46.906.31	130	145	145	145/155	-
Rear	46.906.22	46.906.32	130	155	145	150/170	-
Rear	46.906.23	46.906.33	130	170	145	175/185	-
Rear	46.906.24	46.906.34	130	190	145	190/205	-

\* Folded

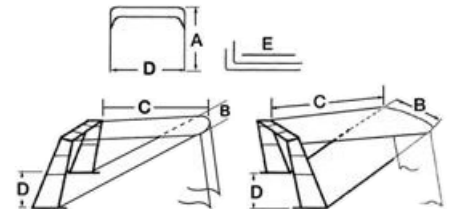

### Bimini top with telescopic arms for T-Tops, stiff roofs and Flying bridge roofs

Stainless steel telescopic arms (1.3/2 m) to slip into the fishing rod holder. Adjustable height. It can be folded when not in use.

When open it can be used up to a 20-knot speed. ATLAS 300 gr/m<sup>2</sup> fabric, waterproof and UV-resistant.



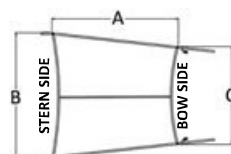

navy blue	A cm	B cm	C cm
46.907.01	180	150	120
46.907.03	210	210	150
46.907.05	260	200	170
46.907.07	260	230	200
46.907.09	290	260	230
46.907.11	290	290	260



**Front extension bimini top for T-tops**

Made of waterproof UV-resistant CYCLONE™ 220 gr/m<sup>2</sup> fabric.  
Ideal to protect the cushions from the sun.

Code	A cm	B cm	Colour
48.198.01	200	275	 Navy blue
48.198.03	245	290	 Navy blue
48.198.04	275	305	 Navy blue



**CYCLONE™**  
DOPE DYED  
POLYESTER FABRIC  
220g/m<sup>2</sup> - 6.5oz/yd<sup>2</sup>

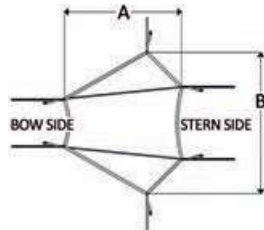

**OCEANSOUTH awning**

Made of UV-resistant (grade 6/7) Cyclone 220 gr/m<sup>2</sup> fabric. Central rear opening with hook&loop fastener and buckle for lifting.  
Side fixing tapes included.

Grey	Width cm	Length cm	Rear opening cm
46.899.01	250	240	85
46.899.02	300	320	120
46.899.03	360	420	120

OCEANSOUTH



**Support plate for handrails**

Made of **white nylon**, designed to make an awning support arch using stainless steel handrails.

Code	For pipes Ø mm	
46.107.10	22	2

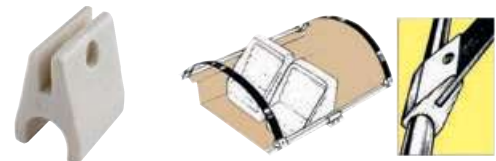



 **58.660.45; 58.660.52** *OPTIONAL Fibreglass bars*

**Awning support plate**

Made of **chromed brass**, when fixed to the handrails it forms an arch that supports the tarpaulin; fitted with **white PVC** cover.

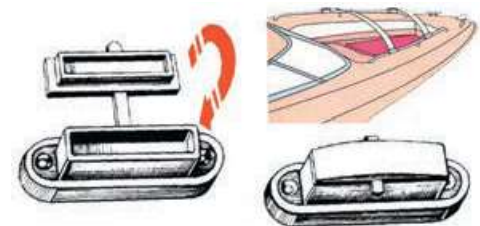
Code	mm	
46.108.00	67x14	2



 **58.660.45; 58.660.52** *OPTIONAL Fibreglass bars*

**Fork + bushing**

**AISI 316**

Made of **mirror polished precision cast AISI 316 stainless steel**; designed to create movable fibreglass or wooden arcs to support boat awnings.

Code	Flange bush mm	Fork pin Ø mm
46.109.00	25x50	8

 **58.660.50; 58.660.51; 58.660.52; 58.660.45** *OPTIONAL Fibreglass bars*

OSCOLATI

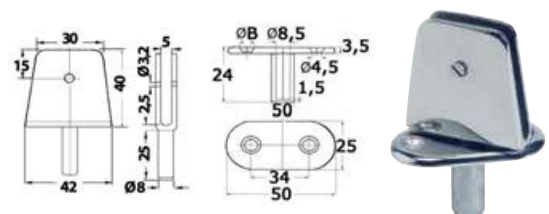

**Console covers for open hulls**

Polyurethane-coated polyester fabric, elastic edge for better fit. UV-resistant.

Code	Model	A cm	B cm	C cm	D cm	E cm	Fabric deniers
46.509.03	M1	115	45	45	15	90	300 D
46.509.02	M2	90	70	80	15	65	300 D
46.509.05	M3	110	70	65	15	95	300 D
46.509.07	M4	125	90	70	15	100	300 D
46.509.08	M5	130	100	90	15	105	300 D
46.509.09	M6	135	110	120	15	110	300 D

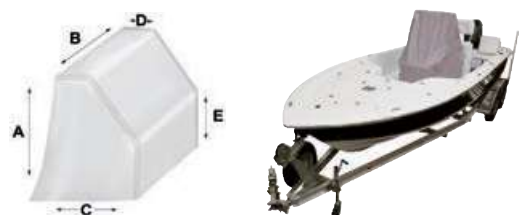

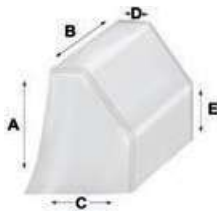

**TESSILMARE control panel cover for open boats**

Made of **water-resistant white polyester fabric**.

Code	Model	A cm	B cm	C cm	D cm	E cm
46.896.01	Small	125	80	65	25	60
46.896.02	Medium	135	100	70	30	65
46.896.03	Large	145	120	75	35	70

**OSCOLATI**



**Fabric seat cover**

Made of polyester fabric and waterproof polyurethane coating.

Code	AxBxH cm	Colour	Fabric deniers	For seat
48.688.01	45x55x53	Grey	300 D	Single-seater
48.688.02	60x60x65	Grey	300 D	Single-seater
48.688.03	53x90x89	Grey	300 D	Two-seat



**Protective storage bag for outboard engines**

Made of sturdy **polyester fabric**, covered internally with shock-resistant padded material, oil and fuel resistant, nylon zip closure; adjustable straps suited to carry by hand or on the back; ideal for stowing auxiliary engines, for carrying or for winter storage.

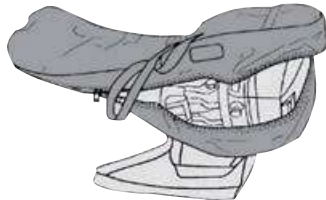

Code	For outboards up to
46.151.00	5 HP
46.152.00	6/15 HP
46.153.00	20/30 HP

**OSCOLATI**



**Engine covers made of fabric**

Made of polyester fabric and waterproof polyurethane lining. UV resistant.

Code	cm			HP	Color	Fabric deniers
	A	B	H			
46.505.01	40	25	32	2/4	Grey	300 D
46.505.02	48	27	35	5/15	Grey	300 D
46.505.03	55	33	45	15/30	Grey	300 D
46.505.04	63	35	50	30/60	Grey	300 D
46.505.05	73	40	65	60/100	Grey	300 D
46.505.06	75	45	75	100/150	Grey	300 D

**OCEANSOUTH**



**OCEANSOUTH Top Quality cover for 2/4-stroke outboard engine - Engine head**

Version for engine head.  
Made of waterproof UV-resistant 320 g/m Cyclone polyester fabric lined with plush to avoid scratching the paint when folding the engine. Reinforced and sealed seams.



Code	HP	cm			Colour
		(L) length	(W) width	(H) height	
46.537.01	2-4	40	24	27	Grey
46.537.02	5-15	52	27	32	Grey
46.537.03	15-30	56	30	40	Grey
46.537.04	30-60	62	36	49	Grey
46.537.05	60-100	68	40	53	Grey
46.537.06	115-150	74	46	58	Grey
46.537.07	175-250	82	50	60	Grey

**OCEANSOUTH Top Quality cover for 2/4-stroke outboard engine - Complete engine**

Version for the whole outboard engine.  
 Made of waterproof UV-resistant 320 g/m Cyclone polyester fabric lined with plush to avoid scratching the paint. Reinforced and sealed seams.  
 The closure is fitted with a reinforced profile and a 10# nylon zip fastener.

Code	HP	Circumference cm	Height cm (H)	Colour
46.538.01	Fino a 3,5	126	98	Grey
46.538.02	3,5-6	140	110	Grey
46.538.03	8-20	150	125	Grey
46.538.04	9,9-30	165	137	Grey
46.538.05	25-60	180	144	Grey
46.538.06	30-90	200	170	Grey
46.538.07	70-150	226	190	Grey
46.538.08	135-250	248	197	Grey
46.538.09	200-350	254	198	Grey
46.538.10	225-350	254	210	Grey

OCEANSOUTH



**CYCLONE PROTECT™**  
 PERMANENT WORKING POLYESTER FABRIC  
 WITH NON WOVEN BACKING

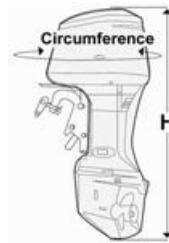

**Tailored cover for MERCURY engines**

Made to measure for the engine model. For storage in outdoor areas. **Colour matches the engine (black).**

For engine head		For complete engine	Engine	HP	Year	Leg
To be used when the engine is off	Ventilated – can also be used during navigation					
-	46.540.34	-	V12 7,6L	600	2021>	-
-	-	46.550.49 <b>New</b>	V12 7,6L	600	2021>	25"
-	-	46.550.50 <b>New</b>	V12 7,6L	600	2021>	30"
-	-	46.550.51 <b>New</b>	V12 7,6L	600	2021>	35"
-	46.540.35	-	V8 4,6L	250/480	2018>	-
-	-	46.550.02	V8 4,6L	250/480	2018>	25"
-	-	46.550.03	V8 4,6L	250/480	2018>	30"
46.540.01	46.540.11	46.550.04	Verado 6 cylinder 2.6L	200/400	2005>	25"
-	-	46.550.05	Verado 6 cylinder 2.6L	200/400	2005>	30"
-	46.540.36	46.550.07	V6 3,4L	175/225	2018>	25"
-	-	46.550.08	V6 3,4L	175/225	2018>	30"
46.540.02	46.540.12	46.550.09	Verado 4T 1.7L cc	135/200	2005>	20"
-	-	46.550.10	Verado 4T 1.7L cc	135/200	2005>	25"
46.540.03	46.540.13	46.550.12	4 cylinder 4T 3L	135/150	2011>	20"
-	-	46.550.13	4 cylinder 4T 3L	135/150	2011>	25"
46.540.04	46.540.14	46.550.15	4 cylinder 4T 2.1L	75/115	2014>	20"
-	-	46.550.16	4 cylinder 4T 2.1L	75/115	2014>	25"
46.540.05	46.540.15	-	4 cylinder 4T 995 cc	40/60	2008>	15"
-	-	46.550.19	4 cylinder 4T 995 cc	40/60	2008>	20"
-	-	46.550.20	4 cylinder 4T 995 cc	40/60	2008>	25"
46.540.06	46.540.16	46.550.21	3 cylinder 4T 747 cc	40	2008>	15"
-	-	46.550.22	3 cylinder 4T 747 cc	40	2008>	20"
-	46.540.23	-	3 cylinder 4T 500 cc	25/30	2022>	-
-	46.540.24	46.550.24	3 cylinder 4T 526 cc	25/30	2007>	15"
-	-	46.550.26	3 cylinder 4T 526 cc	25/30	2007>	20"
-	46.540.18	46.550.27	2 cylinder 4T 333 cc	15/20	2018>	15"
-	-	46.550.28	2 cylinder 4T 333 cc	15/20	2018>	20"
-	46.540.19	46.550.30	2 cylinder 4T 209 cc	8/9,9	2006>	15"
-	-	46.550.31	2 cylinder 4T 209 cc	8/9,9	2006>	20"
-	46.540.20	46.550.33	1 cylinder 4T 123 cc	4/5/6	2012>	15"
-	-	46.550.34	1 cylinder 4T 123 cc	4/5/6	2012>	20"
-	46.540.21	46.550.36	1 cylinder 4T 85 cc	2.5/3.5	2007>	15"
-	-	46.550.37	1 cylinder 4T 85 cc	2.5/3.5	2007>	20"

OCEANSOUTH



**CYCLONE PROTECT™**  
 PERMANENT WORKING POLYESTER FABRIC  
 WITH NON WOVEN BACKING





OCEANSOUTH



**Tailored cover for YAMAHA engines**

Made to measure for the engine model. For storage in outdoor areas. **Colour matches the engine (grey).**

To be used when the engine is off	For engine head		Engine	HP	Year	Leg
	Ventilated – can also be used during navigation	For complete engine				
-	46.541.35	46.551.01	XTO V8 5.6L	375/425	2018>	25"
-	-	46.551.02	XTO V8 5.6L	375/425	2018>	30"
-	-	46.551.03	XTO V8 5.6L	375/425	2018>	35"
46.541.01	-	46.551.04	V8 4T 5.3L	350	2007>	25"
-	-	46.551.05	V8 4T 5.3L	350	2007>	30"
46.541.42	46.541.52	-	V6 4T 4.2L	F225/250/300	2021>	-
46.541.02	46.541.12	46.551.07	V6 4T 4.2L	F225F/F250D/F300B	2010-2020	25"
-	-	46.551.08	V6 4T 4.2L	F225F/F250D/F300B	2010-2020	30"
46.541.03	46.541.13	46.551.10	4 cylinders 4S 2.8L	F150/175/200	2015>	20"
-	-	46.551.11	4 cylinders 4S 2.8L	F150/175/200	2015>	25"
46.541.04	-	-	4 cylinders 4S 2.7L	F150D	2013<	-
46.541.05	46.541.15	46.551.13	4 cylinders 4S 1.8L	115/130	2014>	20"
-	-	46.551.14	4 cylinders 4S 1.8L	115/130	2014>	25"
-	46.541.20	46.551.16	4 cylinders 4S 1.8L	F75DF90C/F100F	2017>	20"
-	-	46.551.17	4 cylinders 4S 1.8L	75/100	2017>	25"
46.541.06	46.541.16	46.551.19	4 cylinders 4S 996 cc	F50/60/70	2010>	20"
46.541.07	46.541.17	46.551.21	3 cylinders 4S 747 cc	F30/40	2009>	20"
46.541.08	46.541.18	-	2 cylinders 4S 498 cc	F25 D	2010>	20"
-	46.541.19	46.551.23	2 cylinders 4S 432 cc	F25 C/G	2017>	15"
-	-	46.551.24	2 cylinders 4S 432 cc	F25 C/G	2017>	20"
-	46.541.30	46.551.26	2 cylinders 4S 362 cc	F15C/F20B	2007>	15"
-	-	46.551.27	2 cylinders 4S 362 cc	F15C/F20B	2007>	20"
-	46.541.21	46.551.29	2 cylinders 4S 212 cc	F8F/F9,9J	2013>	15"
-	-	46.551.30	2 cylinders 4S 212 cc	F8F/F9,9J	2013>	20"
-	46.541.22	46.551.32	1 cylinder 4S 139 cc	F4B/F5A/F6C	2010>	15"
-	-	46.551.33	1 cylinder 4S 139 cc	F4B/F5A/F6C	2010>	20"
-	46.541.23	46.551.35	1 cylinder 4S 72 cc	F2.5B	2015>	15"

OCEANSOUTH



**Tailored cover for HONDA engines**

Made to measure for the engine model. For storage in outdoor areas. **Honda grey colour.**

Ventilated – can also be used during navigation	For complete engine	Engine	HP	Year	Leg
46.544.11	-	BF200D/225D/250D V6 3.6L	175/250	2011 >	20"
-	46.553.00 <b>New</b>	BF175/200/225/250 V6 3.6L	175/250	2019>	25"
-	46.553.01 <b>New</b>	BF175/200/225/250 V6 3.6L	175/250	2019>	30"
-	46.553.02	BF200D/225D/250D V6 3.6L	250	2011-2018	25"
-	46.553.03	BF200D/225D/250D V6 3.6L	250	2011-2018	30"
46.544.12	-	BF175/200/225 V6 3.5L	175/225	2011-2018	20"
-	46.553.05	BF175/200/225 V6 3.5L	175/225	2011-2018	25"
-	46.553.06	BF175/200/225 V6 3.5L	175/225	2010 >	30"
46.544.23	-	BF115/150	115/140/150	2023 >	-
46.544.13	46.553.07	BF115/135/150 4 cylinders 2.3L	115/135/150	2010 >	20"
-	46.553.08	BF115/135/150 4 cylinders 2.3L	115/135/150	2010 >	25"
46.544.14	46.553.10	BF75/80/90/100 4 cylinders 1.5L	75/80/90/100	2014 >	20"
-	46.553.11	BF75/80/90/100 4 cylinders 1.5L	75/80/90/100	2014 >	25"
46.544.15	46.553.13	3 cylinders 1L	60	2009>	20"
-	46.553.14	3 cylinders 1L	60	2009>	25"
46.544.16	46.553.16	BF40/50 3 cylinders 808 cc	40/50	2017 >	20"
-	46.553.17	BF40/50 3 cylinders 808 cc	40/50	2017 >	25"
46.544.17	46.553.19	3 cylinders 552 cc	25/30	2002 >	15"
-	46.553.20	3 cylinders 552 cc	25/30	2002 >	20"
46.544.18	46.553.22	BF 15/20 2 cylinders 350 cc	15/20	2002 >	15"
-	46.553.23	2 cylinders 350 cc	15/20	2002 >	20"
46.544.19	46.553.25	BF8/9,9/10 2 cylinders 222 cc	8/9,9/10	2000 >	15"
-	46.553.26	BF8/9,9/10 2 cylinders 222 cc	8/9,9/10	2000 >	20"
46.544.20	46.553.28	BF4/5/6 1 cylinders 127 cc	4/5/6	2016 >	15"
-	46.553.29	1 cylinders 127 cc	4/6	2016 >	20"
46.544.21	46.553.31	BF 2.3 1 cylinders 57 cc	2.3	2014 >	15"

**Tailored cover for SUZUKI engines**

Made to measure for the engine model. For storage in outdoor areas. **Colour matches the engine (black).**

For engine head		For complete engine	Engine	HP	Year	Leg
To be used when the engine is off	Ventilated – can also be used during navigation					
-	46.542.35	46.552.01	V6 4T 4-4L	DF325/350	2017>	25"
-	-	46.552.02	V6 4T 4-4L	DF325/350	2017>	30"
46.542.01	46.542.11	46.552.04	V6 4T 4L	DF250AP/300AP	2012>	25"
-	-	46.552.05	V6 4T 4L	DF250AP/300AP	2012>	30"
46.542.02	46.542.12	46.552.07	V6 4T 3.6L	DF200/225/250	2003>	25"
-	-	46.552.08	V6 4T 3.6L	DF200/225/250	2003>	30"
46.542.03	46.542.13	-	4-cylinder 4T 2.8L	DF150/DF175	2005>	-
-	46.542.23	46.552.10	4-cylinder 4T 2.8L	DF150AP/175AP/200AP	2014>	25"
-	-	46.552.11	4-cylinder 4T 2.8L	DF150AP/175AP/200AP	2014>	30"
46.542.44	46.542.54	46.552.14 <b>New</b>	4-cylinder 4T 2L	DF115BG/140BG	2021>	20"
-	-	46.552.15 <b>New</b>	4-cylinder 4T 2L	DF115BG/140BG	2021>	25"
46.542.04	46.542.14	46.552.16	4-cylinder 4T 2L	DF100/115/140A	2012-2020	20"
-	-	46.552.17	4-cylinder 4T 2L	DF100/115/140A	2012-2020	25"
46.542.05	46.542.15	46.552.19	4-cylinder 4T 1.5L	DF70/80/90A	2008>	20"
-	-	46.552.20	4-cylinder 4T 1.5L	DF70/80/90A	2008>	25"
46.542.06	46.542.16	46.552.22	3-cylinder 4T	DF40/50/60A	2010>	20"
-	-	46.552.23	3-cylinder 4T	DF25A/30/40/60	2010>	25"
46.542.07	46.542.17	46.552.25	3-cylinder 4T	DF25A/30	2014>	20"
-	-	46.552.26	3-cylinder 4T	DF25A/30	2014>	25"
-	46.542.18	46.552.28	2-cylinder 4T 327 cc	DF15/20A	2012>	15"
-	-	46.552.29	2-cylinder 4T 327 cc	DF15/20A	2012>	20"
-	46.542.19	46.552.31	1-cylinder 4T 208 cc	DF8/9.9A	2010>	15"
-	-	46.552.32	1-cylinder 4T 208 cc	DF8/9.9A	2010>	20"
-	46.542.20	46.552.33	1-cylinder 4T 138 cc	DF4/5/6A	2002>	15"
-	-	46.552.34	1-cylinder 4T 138 cc	DF4/5/6A	2002>	20"
-	46.542.21	46.552.36	1-cylinder 4T 68 cc	DF2,5	2006>	15"

OCEANSOUTH



**Tailored cover for EVINRUDE engines**

Made to measure for the engine model. suitable for outdoor storage. **Colour: grey/blue.**

To be used when the engine is off	Ventilated – can also be used during navigation	Engine	HP	Year
46.543.01	46.543.11	G2 V6 3.4L	225/300HP	2014>
-	46.543.35	G2 V6 2.7L	150/175/200HP	2016>
46.543.02	46.543.12	E-TEC-V6 3.3L	225/300HP	2005-2016
46.543.03	46.543.13	V6 2.6L	150/175/200HP	2004>
46.543.04	46.543.14	E-TEC-V4 1.7L	90/115/130HP	2005>
46.543.05	46.543.15	E-TEC 3CYL	60/75/90HP	2003>
46.543.06	46.543.16	E-TEC 2CYL	40/50/60HP	2003>

OCEANSOUTH



**Accessories for rubber dinghy covers**

**Plastic hooks**

Designed to fasten RIB covers onto rubbing strake; can be used vertically or with the continuous shock cord.

Code	Color	ORDER BY BOX
66.111.00	Black	12

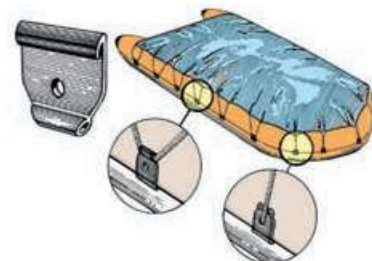

**Plastic hook**

Designed for ribs' canopies, fitted with 25mm belt adjuster

Code	Color	ORDER BY BOX
66.592.00	Black	12

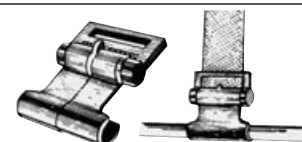

## Tarpaulins and boat covers

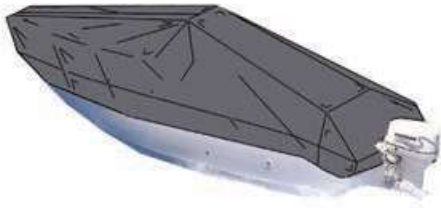

### Boat cover - suitable for open boats with central control panel

Made of sturdy waterproof and UV-resistant polyester fabric in **grey or blue colour (until stock lasts)**. Its rugged structure makes it suitable for use when the boat is being trailed on the road.

Code	Suitable for boats	
	length m	width m
46.170.01	4.2 / 4.4	1.8
46.170.03	4.4 / 4.7	1.9
46.170.05	4.8 / 5.2	2
46.170.07	5.3 / 5.7	2.1
46.170.09	5.8 / 6.3	2.4
46.170.11	6.3 / 6.8	2.4
46.170.13	7 / 7.7	2.6

**OSCULATI**



### Cover for inflatables/tenders

Made of polyester fabric with polyurethane waterproof lining, elastic on the perimeter for better fitting to the boat broadsides. UV resistant. Double seams, perimeter rings to tension the cover.

Code	Tender A length cm	Color	Fabric deniers
46.501.01	240 - 300	Grey	300 D
46.501.02	300 - 360	Grey	300 D



**OSCULATI**



### Cover for open hulls with central steering dashboard/decked hulls with windscreen

Made of polyester fabric with waterproof polyurethane coating, elastic on the perimeter for better fitting to the boat broadsides. UV resistant. Double seams, perimeter rings to tension the cover.

Code	Boat dimensions		Colour	Fabric deniers
	length A cm	width B cm		
46.503.01*	427/488	180	Grey	300D
46.503.03	427/488	210	Grey	300D
46.503.06	488/564	225	Grey	300D
46.503.07	518/579	230	Grey	300D
46.503.09	550/610	240	Grey	300D
46.503.11	580/650	250	Grey	300D
46.503.13	630/710	260	Grey	600D
46.503.15	700/780	270	Grey	600D

\* Low console



46.503.01

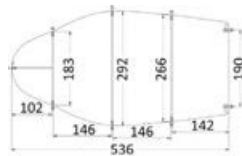

46.503.03

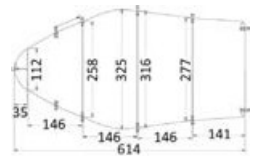

46.503.06

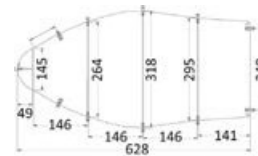

46.503.07

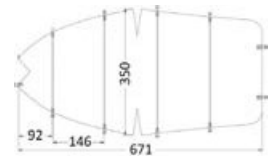

46.503.09

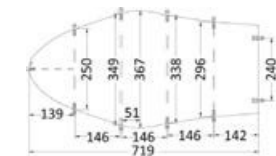

46.503.11

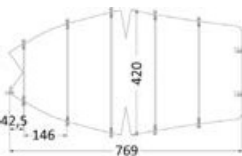

46.503.13

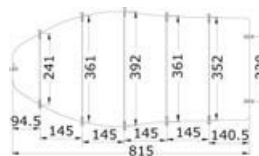

46.503.15



**OCEANSOUTH**

### Dinghy cover

Suitable for round/square bow dinghies. Designed to cover also the outboard engine. Breathable and UV-resistant fabric. It can be used for towing on trailer up to a 60-km/h speed.

Code	Dinghy size		tarpaulin		Color
	Length cm	Width cm	Length cm	Width cm	
46.166.01	230/260	150	328	235	Grey
46.166.02	260/290	155	358	245	Grey
46.166.03	290/320	165	393	255	Grey
46.166.04	320/360	175	433	266	Grey
46.166.05	360/390	190	465	281	Grey
46.166.06	390/430	200	511	300	Grey
46.166.07	430/470	210	551	310	Grey



**Open hull tarpaulin**

They can mount side handrails up to 150-mm high. Made of sturdy waterproof Cyclone polyester. Breathable and UV-resistant fabric suitable for road towing up to 60 km/h speed.

Code	Boat dimensions		cover	
	Length cm	Max width cm	Length cm	Width cm
46.203.21	370/390	170	450	215
46.203.31	390/410	180	470	225
46.203.41	410/430	195	490	240
46.203.51	430/450	205	510	250
46.203.56	450/470	205	530	250
46.203.61	470/500	225	560	270
46.203.62	500/530	225	590	270



**UNIVERSAL STORAGE tarpaulin**

Suitable for: open hulls, decked/half-decked hulls with or without windshield, hulls with central/lateral steering dashboard. For seasonal laying-up. Made of breathable and UV-resistant fabric.

Code	Boat size		tarpaulin		Color
	Length cm	Max width cm	Length cm	Width cm	
46.167.02	400/450	205	522	280	Grey
46.167.03	450/540	240	595	340	Grey
46.167.04	540/640	260	719	340	Grey



**Universal multipurpose cover**

Suitable for: hulls, decked/half-decked hulls with or without windshield, hulls with central/lateral steering dashboard. Made of very sturdy breathable and UV-resistant polyester fabric rated for road towing up to 60 km/h. For long-term indoor or outdoor laying up.

Code	Boat size		tarpaulin		Color
	length cm	max width cm	length cm	width cm	
46.169.02	400/450	205	522	280	grey
46.169.03	450/540	240	595	340	grey
46.169.04	540/640	260	718	355	grey



**Centre Console tailored cover for open hulls with centre console.**

Made of sturdy Cyclone polyester rated for road towing use up to 60 km/h. Breathable and UV-resistant fabric.

Code	Boat dimensions		cover		Color
	length cm	max width cm	length cm	width cm	
46.172.01	470/500	225	582	327	Grey
46.172.02	500/530	240	612	342	Grey
46.172.03	530/560	240	642	342	Grey
46.172.04	560/590	245	672	347	Grey
46.172.05	590/630	250	712	352	Grey
46.172.06	630/670	250	752	352	Grey



**Jumbo made-to-measure cover for cabins/semicabins/T-Top**

Made of sturdy Cyclone polyester rated for road towing up to 60 km/h. Breathable and UV-resistant fabric.

Code	Boat size			tarpaulin		Colour
	length cm	max width cm	max height from stringer cm	length cm	width cm	
46.171.01	580/640	240	135	818	530	Grey
46.171.02	640/700	250	135	883	550	Grey
46.171.03	700/760	270	150	948	570	Grey
46.171.04	760/820	290	150	1008	590	Grey





### Tailored tarpaulin for dinghies

Opening for A-frame, if any.  
280 g/m<sup>2</sup> high-strength UV-resistant breathable fabric, also for use for **towing trailers** up to 60 km/h.  
Zip and hoop&loop fastening. Two Cam Cleats make it easy to stretch the tarpaulin.

Code	Dinghie size		←→  tarpaulin		Colour
	length cm	width cm	length cm	width cm	
46.165.01	470/500	230	600	370	Grey
46.165.02	510/530	230	660	380	Grey
46.165.03	540/560	230	700	390	Grey
46.165.04	570/590	230	730	400	Grey
46.165.05	600/630	230	760	420	Grey
46.165.06	640/670	250	790	430	Grey
46.165.07	680/710	280	840	450	Grey
46.165.08	720/750	280	870	460	Grey
46.165.09	760/790	280	910	470	Grey
46.165.10	800/830	280	950	480	Grey
46.165.11	840/870	310	1000	500	Grey
46.165.12	880/910	310	1050	510	Grey



### TESSILMARE



### TESSILMARE cover for boats with windscreen and Day Cruiser.

Made of 1000-denier heavy duty fabric, also suitable for transport on boat trailers. Made of very sturdy Supermare fabric.

Code	Hull length cm	Tarpaulin size cm
46.178.20	430/460	510x250
46.178.30	470/500	550x280
46.178.40	510/550	600x292
46.178.50	560/600	620x270
46.178.55	620/650	690x300
46.178.60	670/700	745x320

### OSCULATI



### Telescopic cover support

Made of **anodized light alloy**, fitted with wide soft **PVC** top support to avoid damaging the tarpaulin.

Code	Pipe Ø mm	Adjustable from cm
46.100.01	25/30	75/120
46.100.02	25/30	90/160

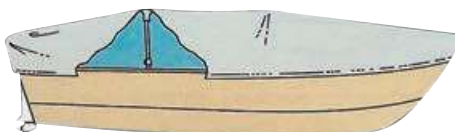

### Telescopic support for covers

Made of 22/25-mm Ø aluminium tube. Fitted with upper and lower **Wheels-like rests** for better stability. It comes with 20-m adjustable fastening belts and snap buckles.

Code	Description	For hulls max m
46.100.04	Cover support	7.5



**Elastic hooks**

Code	Colour	Length mm
46.091.80	White	80
46.092.80	Black	80



**Boat cover vent**

Easy to fasten (as little as 4 screws), it keeps air circulating under your boat cover to fight mold and mildew.

Code	Description	mm
46.102.00	Air vent	107x112



**INDOOR sea cover**

Polyethylene sheet to protect boats in marinas. Supplied in 50-m rolls with continuous elastics on the outer sides.

**Mounting instructions**

- 1) unroll the cover from stern to stem keeping central on the boat and leaving a surplus of about 50 cm on either side
- 2) apply two straps 30 cm one from the other and cut the sheet from the roll
- 3) take the elastics out and tie them
- 4) open the cover over the boat
- 5) pull the elastic from one of its ends and tie it to keep it tight
- 6) if necessary, use the special reinforced pre-cuts to connect the outer elastic crosswise.

Code	Cover width m	Roll length m
46.174.00	4	50
46.174.01	6	50
46.174.02	8	50
46.174.03	10	50
46.174.04	15	50



▲3

▲4

**Marine heat-shrink covering**

White polyethylene heat-shrink film. Special additive for UV-ray resistance. Ideal covering to protect whatever boat from dirt, minor impacts, high temperature, etc. during laying up/transport. Easy application by spreading the product from bow to stern and heating it up with the dedicated heat guns.

Product sold in rolls (price depends on weight).

Code	Film width m	Roll length m	Roll height m	Thickness mm	Approximate weight kg	Bending	UV Resistance
46.176.06	6	65	1.5/1.6	0.2	76.6	bellows-bending	12-month warranty
46.176.08	8	50	1	0.2	77.7	multiple bending	12-month warranty
46.176.10	10	50	1.25	0.2	97.1	multiple bending	12-month warranty
46.176.12	12	50	1.5	0.2	116.5	multiple bending	12-month warranty
46.176.14	14	50	1.75	0.2	135.9	multiple bending	12-month warranty
46.176.16	16	50	2	0.18	140.1	multiple bending	12-month warranty

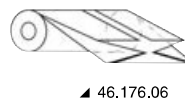

▲ 46.176.06

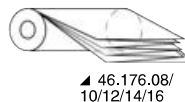

▲ 46.176.08/10/12/14/16





▲ 46.188.02

### Air vents for heat-shrinking covering

Good protection against the ingress of unwanted external agents to prevent condensate, mould and bad odours

Code	Description
46.188.01	Piercieng triangular vent
46.188.02	Adhesive round vent



▲ 46.177.00



▲ 46.177.10/12/13/15/16

### Rafale Black Edition + propane gas shrinkforming gun

Propane gas shrinkforming gun for polyethylene. Weighing 1.17 kg, and combining ergonomics and comfortable noise levels (88dB at 1-m distance - 85dB), Rafale Black Edition has been designed to limit user's fatigue as much as possible, even after several working hours.

Air consumption: 48 to 72.2 m<sup>3</sup>/h; flow: 3.2 to 4.8 kg/h. 1.3-mm diameter injector, 360° swivelling head for use in any position. Aluminium nozzle surrounded by a double protection, which means that it always stays warm regardless of the duration and intensity of use. Power can be set from 44 to 66 kW/h. Delivered in a case containing: pressure regulator adjustable from 1.5 to 3.5 bar, 8-m rubber hose complying with NF EN 559, 1 instruction manual, 1 pair of gloves, 1 heat deflector. CE mark No 4450.

Code	Description
46.177.00	Propane gas shrinkforming gun (faucet not included)
46.177.10	Pressure regulator and pressure gauge for shrinkforming gun with fitting for Algeria, Belgium, Spain, France, Hungary, Luxembourg, Morocco, Holland, Poland, Portugal, Czech Republic, Switzerland, Tunisia.
46.177.12	Pressure regulator and pressure gauge for shrinkforming gun with fitting for UK, Canada, Ireland.
46.177.13	Pressure regulator and pressure gauge for shrinkforming gun with fitting for Italy and Greece.
46.177.15	Pressure regulator and pressure gauge for shrinkforming gun with fitting for Turkey.
46.177.16	Pressure regulator and pressure gauge for shrinkforming gun with fitting for Russia.

To use the gun, also order the suitable fitting (to be chosen depending on the country of use).



### New Gas bottle trolley

This gas bottle trolley is easy to mount, lightweight, foldable and handy. It comes with straps to fasten the bottle during transport and a bracket for the shrinkforming gun (code 46.177.00).

Code	Max capacity kg	Wheel Ø mm	←→  mm		kg
			open (LxWxH)	closed (LxWxH)	
46.177.30	13	145	106x45x40	60x40x26	7.5



### Heat-shrinking polyethylene adhesive tape

To join, seal and repair heat-shrinking film. Also used when installing fixtures such as doors, openings, vents, etc. Resistant to abrasion, UV rays, weather and chemical agents.

Code	Width mm	Length m
46.186.00	50	33
46.186.01	96	55



### Polyethylene doors and openings.

To enable access to the structure.

Code	Outer mm	Fastening
46.187.01	1750x750	Zip